

Ho Re Ca bert

CATALOGO 2022

STORIA STORIA

STORIA

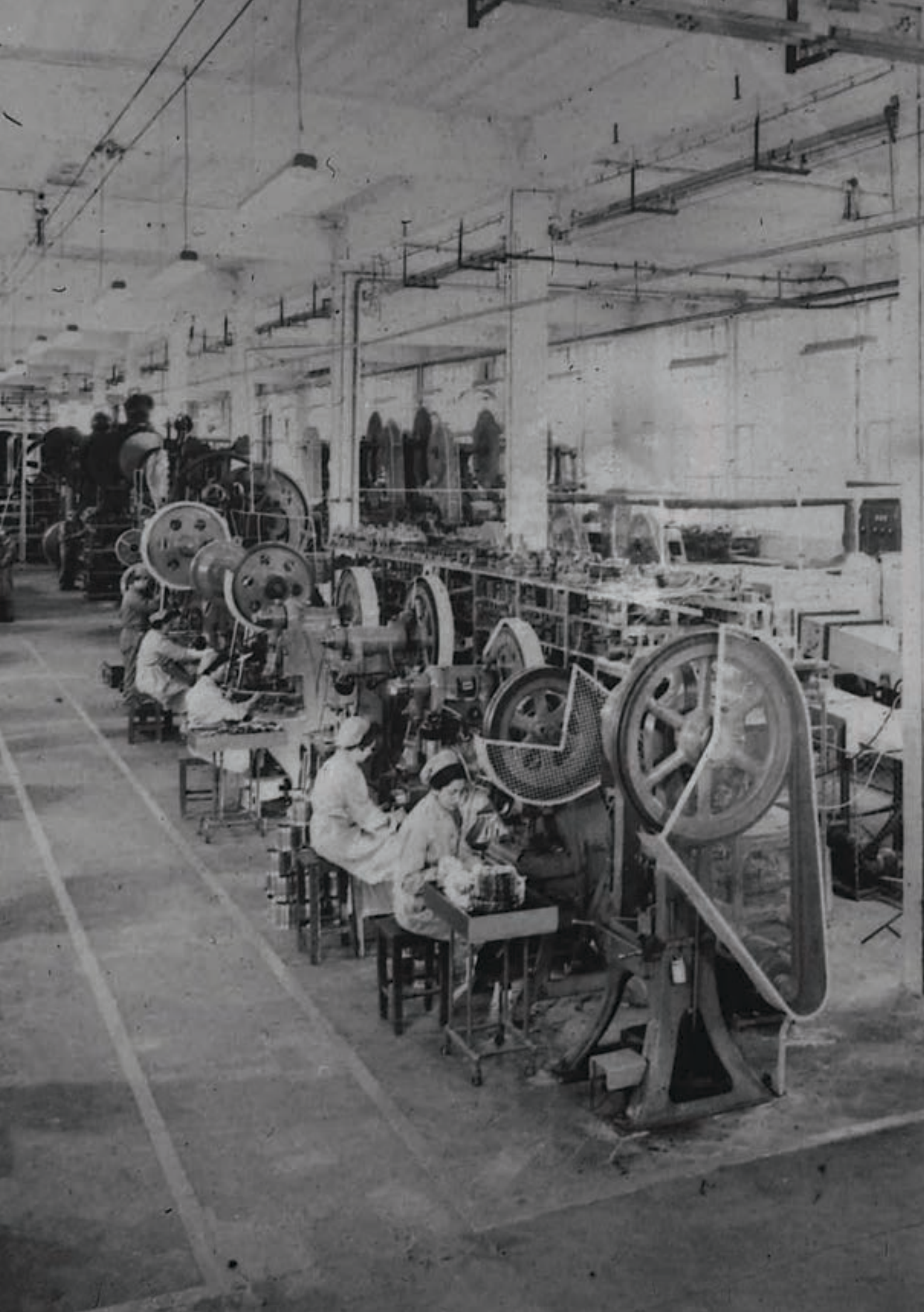

INTRODUZIONE

LEADER NEL SETTORE DELLA POSATERIA, NEGLI ACCESSORI PER LA TAVOLA E NEI PRODOTTI HO.RE.CA.

DAL 1929 Abert si è distinta per la sua abilità nell'interpretazione del mercato, la consapevolezza ambientale e l'etica nel lavoro e nelle relazioni sociali.

Icona di eccellente QUALITÀ, forte della sua ESPERIENZA nel MADE-IN-ITALY, Abert è anche sinonimo di costante apertura a tutto ciò che è INNOVAZIONE ed attualità.

Il CORE BUSINESS dell'azienda è la produzione ed il mercato di POSATE A MARCHIO ABERT, che si caratterizzano in linee dal differente posizionamento commercializzate in diversi canali di distribuzione.

Nell'ultimo decennio, il portfolio prodotti è stato integrato con ARTICOLI PER LA TAVOLA, LA CUCINA E LA COTTURA fornita da PROMAB ed a partire dal 2015, con i PRODOTTI IN CERAMICA VISTA ALEGRE.

I NOSTRI NUMERI

LEADER NEL MERCATO ITALIANO, EXPORT IN PIÙ DI 80 PAESI

140 dipendenti circa

2 aree produttive situate a Passirano (BS), Italia:

- 10.000 m2 dedicati alla produzione e lucidatura

- 21.000 m2 dedicati al confezionamento e stoccaggio

1 area produttiva situata a Lumezzane (BS), Italia:

- 6.700 m2 dedicati alla produzione e lucidatura

Capacità di produzione posate: 40 MILIONI PEZZI/ANNO

I NOSTRI PUNTI DI FORZA

ECCELLENTE QUALITÀ garantita da:

- KNOW-HOW
- GARANZIA per ogni prodotto
- CERTIFICAZIONE ISO 9001

MADE IN ITALY nel rispetto dei diritti e della sicurezza dei lavoratori, dell'ambiente e della creatività italiana.

FLESSIBILITÀ E PERSONALIZZAZIONE per soddisfare ogni necessità del cliente.

Alto livello di SERVIZIO nella gestione di qualsiasi ordine.

VASTA GAMMA di prodotti che copre tutti i posizionamenti (medio, medio/alto, alto) in ogni canale di distribuzione.

PERCHÈ SCEGLIERCI

PROPOSTA COMPLETA E INTEGRATA: dalle posate, agli articoli professionali, ai complementi tavola e cucina ALTA QUALITÀ dei prodotti.

Massima possibilità di PERSONALIZZAZIONE dei prodotti e dei servizi.

AFFIDABILITÀ E CONTINUITÀ degli assortimenti.

PRESENZA CAPILLARE sul territorio e grande attenzione al servizio al cliente.

RAPIDITÀ NELLA GESTIONE dell'ordine e nella consegna, grazie all'informatizzazione dei processi, ad un livello di scorta costante e ad un magazzino automatizzato.

INTRODUCTION

LEADER IN THE CUTLERY SECTOR, TABLE ACCESSORIES AND HO.RE.CA. PRODUCTS

SINCE 1929 Abert has distinguished itself by its ability in interpreting the market, environmental awareness and ethics in business and social relationships.

Symbol of QUALITY excellence, MADE-IN-ITALY consolidated EXPERIENCE and constant opening to all that is INNOVATIVE AND TRENDY.

The CORE BUSINESS is the production and marketing of ABERT and BROGGI branded CUTLERY, which differ for positioning and distribution channels.

In the last decade, the product portfolio has been integrated with PROMAB KITCHEN BRANDED PRODUCTS, and from 2015 with VISTA ALEGRE, Portuguese PORCELAIN PRODUCER.

FACTS & FIGURES

LEADER IN THE ITALIAN MARKET
EXPORTS IN OVER 80 COUNTRIES

140 employees

2 industrial sites located in Passirano (BS), Italy

- 10.000 m2 dedicated to production and polishing

- 21.000 m2 dedicated to packaging and warehousing

1 industrial site based in Lumezzane (BS), Italy:

- 6.700 m2 dedicated to the production and polishing

Cutlery production capacity: 40 MILLION PCS/YEAR

OUR STRENGTHS

EXCELLENT QUALITY guaranteed by:

- KNOW-HOW derived by Abert and Broggi tradition
- WARRANTY for all products
- ISO 9001 CERTIFICATION

MADE-IN-ITALY production, in respect to the rights and safety of workers, to the environment and devoted to the Italian creativity.

FLEXIBILITY & PERSONALIZATION to satisfy any need, thanks to customization capability (design, finishing, décor).

HIGH SERVICE level in managing orders, thanks to the level of stocks, automated warehouses and high responsiveness.

WIDE AND COMPLETE RANGE of products covering all positioning (medium, medium/high, high) in each distribution channel.

WHY US

COMPLETE AND INTEGRATED COLLECTION: cutlery, professional items for the ho.re.ca. market, kitchen and table accessories.

Products HIGH QUALITY.

EXTENSIVE CUSTOMIZATION options of products and services.

RELIABILITY and assortment CONTINUITY.

WIDESPREAD COVERAGE on the territory and great focus on customer service.

FAST ORDER MANAGEMENT AND DELIVERY, thanks to digital processes, constant stock level and automated warehouses.



KONECRANES

dommec

IRICH
EL 2500
EL 1000
EL 1500
EL 2000
EL 3000
EL 4000
EL 5000
EL 6000
EL 7000
EL 8000
EL 9000
EL 10000

10000

LA STORIA

1929

Antonio Bertoli fonda Abert e dà inizio alla produzione artigianale di posate in ottone a Lumezzane (Brescia)

1960

Iniziano gli attuali processi industriali, insieme all'automatizzazione produttiva.

1975

Abert è la prima azienda al mondo a ingegnerizzare i processi per la produzione di posate colorate, con la combinazione di acciaio inossidabile e materiali come ABS, nylon e legno.

1987

La sede si trasferisce a Passirano (Brescia).

1992

Viene acquisita Facix Srl.

1993

Abert acquisisce Broggi, storico marchio milanese leader di mercato nella posateria e nei complementi d'arredo per la tavola nel settore alberghiero.

1994

Abert è la prima azienda del settore ad ottenere la certificazione di qualità ISO 9002.

2000 - 2002

La struttura logistica e produttiva dell'azienda è completamente riorganizzata con la costruzione di una sola area produttiva (10.000 mq) e una sola area logistica (20.000 mq), incrementando la sua efficienza e migliorando la flessibilità, il servizio e l'attenzione al cliente.

2002

Viene fondata PROMAB, per incontrare le esigenze di incrementare l'offerta di prodotti per la cucina in plastica e in metallo.

2007

Integrazione nel polo industriale delle lavorazioni di pulitura.

2015

Abert diventa distributore esclusivo del marchio VISTA ALEGRE, che offre prodotti per la tavola unici e differenziati, con un ottimo rapporto qualità/prezzo.

2016

Viene acquisito il marchio Inoxbeck-Becchetti (azienda leader per i complementi della tavola).

2019

L'azienda compie 90 anni di attività, guidata dalla TERZA generazione della famiglia Bertoli, durante i quali ha consolidato il rapporto con i clienti storici, conquistato nuovi mercati, sviluppato prodotti innovativi utilizzando tecnologie all'avanguardia, sempre con la storica attenzione, cura e passione.

UN'ANIMA CHE RIMANE GIOVANE,
FORTE DI UNA TRADIZIONE PIENA DI VALORI.

MILESTONES

1929

Antonio Bertoli founded Abert and started handicraft production of brass cutlery in Lumezzane (Brescia).

1960

Processing industrialization was started, together with productive automatization.

1975

Abert was the first company in the world to mechanize the production of coloured handle cutlery, matching steel with new materials, such as ABS, nylon and wood.

1987

The new factory in Passirano (Brescia) was inaugurated.

1992

Facix Srl was acquired.

1993

Abert acquired "Broggi", a prestigious company producing high level cutlery and table accessories.

1994

Abert was the first company in its field to get the Certified Management System ISO9002.

2000 - 2002

The logistic and productive structure of the company was completely reorganized with the building of a single production area (10.000 sm) with a single logistic pole (20.000 sm), increasing its efficiency and improving the flexibility, the service and the customer oriented attitude.

2002

PROMAB was established, in order to meet the need of enlarging the offer of kitchen plasticware and metalware.

2007

The production site was extended with Metalpul, the facility dedicated to polishing, in order to increase the efficiency further.

2015

Abert became exclusive distributor of Vista Alegre porcelain products, which offers a wide range of unique table items, with a good quality-price ratio.

2016

Inoxbeck-Becchetti was acquired (Holloware leader industrial company).

TODAY

Almost ninety years after its birth, still led by the Bertoli family on its third generation, Abert goes on aiming at innovation, product quality, sensitivity, listening to customers, based on the capability of changing with the market.

POSATE / FLATWARE **10**

| | |
|----------------------|-----|
| MODERN | 16 |
| CLASSIC | 70 |
| BASIC | 87 |
| FINITURE / FINISHING | 108 |

ACCESSORI / ACCESSORIES **132**

| | |
|--------------------|-----|
| TABLE | 134 |
| BREAK&FAST | 136 |
| COFFEE&DRINKS | 138 |
| TAPAS&APPETIZER | 142 |
| PIZZA&STEAKS | 145 |
| MARISCOS&ESCARGOTS | 153 |
| CHEESE | 154 |
| SERVING | 156 |

INSPIRATION **168**

LIGHTING **186**

TAVOLA / HOLLOWWARE **200**

| | |
|----------------|-----|
| ART&TABLE | 202 |
| CELSIUS | 206 |
| MENAGE | 238 |
| LOUNGE&SERVICE | 242 |

WINE&BAR **246**

PASTICCERIA / PASTRY **266**

BUFFET **286**

| | |
|-------------------|-----|
| DOMINO | 288 |
| COSMO | 318 |
| URBAN | 334 |
| MIX&PLAY | 348 |
| SQUARE REVOLUTION | 358 |
| SQUARE | 360 |
| JAMBEE | 372 |
| IMPERIAL | 376 |
| ACCESSORI BUFFET | 392 |

CARRELLI / TROLLEY **394**

CUCINA / KITCHEN **420**

| | |
|---------------------|-----|
| Alaska /Alaska Inox | 83 |
| Allegra | 37 |
| Amarcord | 18 |
| America | 104 |
| Baguette | 78 |
| Baltic | 51 |
| Baltic Abi | 52 |
| Bivalva Roberta | 106 |
| Bivalva Svezia | 107 |
| Blade / Blade Inox | 91 |
| Boston | 87 |
| Brigitte | 61 |
| Buffet Vintage | 47 |
| Clever | 36 |
| Corona | 99 |
| Corsaro | 102 |
| Cosmos | 60 |
| Dinamica | 38 |
| Dolce Vita | 22 |
| Dream | 23 |
| Ego | 28 |
| Elegant | 24 |
| England | 84 |
| Enrico VIII | 82 |
| Ergo | 26 |
| Euro | 96 |
| Eva | 103 |

| | |
|------------------------|-----|
| Firenze | 88 |
| Flair | 54 |
| Gourmet | 41 |
| Imperial | 75 |
| Infinito | 48 |
| Infinito Copper | 49 |
| Infinito Vintage | 50 |
| Linea | 40 |
| Luisa | 101 |
| Luna | 17 |
| Mare | 63 |
| Marea | 44 |
| Marea Polvere di Luna | 45 |
| Matisse | 55 |
| Matisse Vintage | 56 |
| Matisse Vintage Copper | 59 |
| Matisse Vintage Gold | 58 |
| Med | 64 |
| Milord | 19 |
| Mirage | 46 |
| Monaco | 53 |
| Murano / Murano Inox | 98 |
| Murano con appendino | 105 |
| Naif | 62 |
| Neo | 34 |
| Niagara | 20 |
| Oslo | 100 |

| | |
|--------------------------|----|
| Perla | 76 |
| Rada | 72 |
| Relais | 25 |
| Rimini | 94 |
| Rinascimento | 70 |
| River | 89 |
| Scozia | 86 |
| Silvia | 80 |
| Slim | 29 |
| Splendido | 73 |
| Step | 43 |
| Stilo | 31 |
| Stilo Black | 32 |
| Style | 39 |
| Superior | 33 |
| Tattoo | 65 |
| Tattoo Copper | 66 |
| Tattoo Gold | 68 |
| Tattoo Polvere di Luna | 69 |
| Toronto Inox | 95 |
| Valencia / Valencia Inox | 97 |
| Verve | 85 |
| Victory | 81 |
| Vintage | 77 |
| Wave/a / Wave/a Inox | 92 |

PRO
SSA
TEE

POSATE

Ciclo di produzione

Il ciclo di produzione di forchette e cucchiai inizia con l'operazione di tranciatura (1). Per diminuire lo spessore della tazza rispetto al manico, si procede poi con la laminazione (2), e si prosegue con la rifilatura (3), per dare la forma della tazza o dei rebbi alla posata laminata. Infine si passa alla coniazione (4), nel corso della quale vengono dati la forma e i decori necessari. Per la lavorazione dei coltelli monoblocco forgiati si parte con la tranciatura del tondino in uno spezzone (1), che viene successivamente coniato a caldo (2), in modo da conferirgli una prima forma. Si prosegue con la tranciatura del manico (3) e con l'allungamento della lama (4); in seguito viene effettuata la tranciatura della lama (5), in modo da darle la forma reale. A questo punto rimane da definire la seghettatura sulla lama (6) e rifinire il coltello con le normali operazioni di pulitura. Le fasi di lavorazione dei coltelli a manico cavo forgiati parte con la tranciatura delle valve (1). Le due valve che costituiranno il manico cavo vengono coniate a freddo (2), per dare loro la convessità e i decori, e poi vengono accoppiate e saldate (3): ecco il manico del coltello infine, attraverso un composto autobloccante, viene assemblata e saldata al manico la lama (4), prodotta con le stesse tecniche dei coltelli monoblocco forgiati.

Cutlery manufacturing process

Shearing (1) is the first step in the process of manufacturing forks and spoons. Rolling (2) is used to reduce the bowl thickness compared to that of the handle, and the next step is trimming (3) to give the shape of a bowl or prongs to the laminated implement. The final step is coining (4) during which the implement is shaped and ornamentation stamped. To make forged solid-handle knives the process begins by shearing a bar into a blank (1) that is then hot coined (2) so as to give it some initial shape. Afterwards the handle is sheared (3) and the blade is stretched (4). Then, the blade is sheared (5) so that it takes its final shape. Now blade serration (6) needs to be defined and the knife has to be polished as usual. The first step to make forged hollow-handle knives is shearing the shells (1). The two half-shells that will form the hollow handle are cold-coined (2) to obtain the convexity and stamp the decoration; afterwards the shells are coupled and welded (3). And that is how the knife handle is ready. Finally and by using a self-locking compound the blade, made applying the same techniques used to make forged solid-handle knives, is coupled and welded to the handle (4).

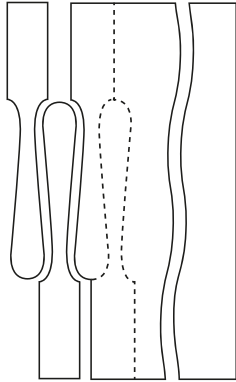

① **Tranciatura**
Blank cutting

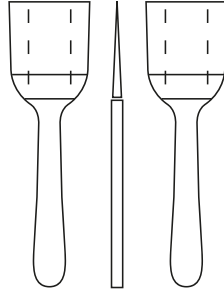

② **Laminazione**
Rolling operation

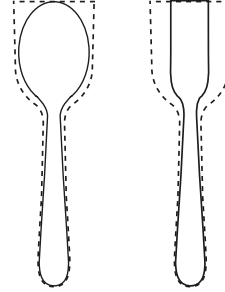

③ **Rifilatura**
Overall cutting on outside blank

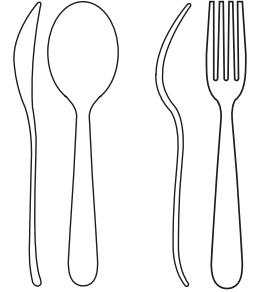

④ **Coniatura**
Pressing operation

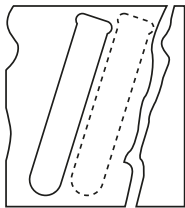

⑤ **Tranciatura**
Blank cutting



⑥ **Coniatura manico**
Handle pressing



⑦ **Saldatura gocce**
Soldering of shells

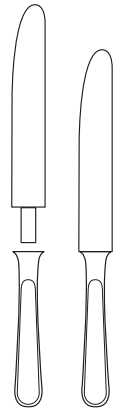

⑧ **Assemblaggio e saldatura lama manico cavo**
Assembling and soldering hollow handle knife



⑨ **Tranciatura spezzone**
Rod cutting

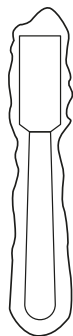

⑩ **Coniatura a caldo**
Forging

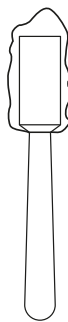

⑪ **Tranciatura manico**
Blank cutting of the blade

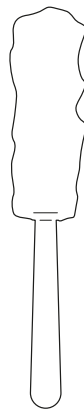

⑫ **Laminazione**
Rolling of the blade

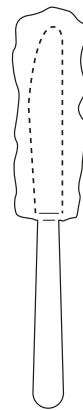



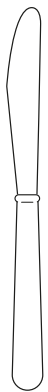









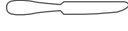
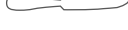
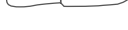







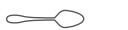
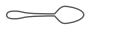











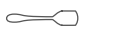

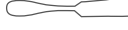



⑬ **Ritanciatura lama**
2nd blank cutting of the blade



⑭ **Seghettatura e finitura**
Blade grinding and finishing

14 • Tabella posate

| | | |
|-----|---|---|
| 01 |  | Cucchiaino tavola Table spoon Cuillère de table Eßlöffel Cuchara mesa |
| 02 |  | Forchetta tavola Table fork Fourchette de table Eßgabel Tenedor mesa |
| 03 |  | Cucchiaino brodo Bouillon spoon Cuillère à soupe Suppenlöffel Cuchara sopa |
| 04 |  | Coltello tavola forgiato pesante Table knife heavy-forged Couteau de table forgé lourd Tafelmesser-schwer Cuchillo mesa forjado pesado * |
| 05 |  | Coltello tavola forgiato Table knife-forged Couteau de table forgé Tafelmesser Cuchillo mesa forjado * |
| 05R |  | Coltello tavola Reverse Reverse table knife-forged Couteau de table Reverse Tafelmesser Reverse Cuchillo mesa Reverse forjado * |
| 06 |  | Coltello tavola leggero Table knife-light Couteau de table léger Tafelmesser-leicht Cuchillo mesa ligero * |
| 08 |  | Coltello tavola m/v saldato Table knife - welded hollow-handle Couteau de table poignée creuse soudée Tafelmesser mit Hohlheft Cuchillo mesa mango hueco soldado * |
| 11 |  | Cucchiaino frutta Dessert spoon Cuillère à dessert Dessertlöffel Cuchara postre |
| 12 |  | Forchetta frutta Dessert fork Fourchette à dessert Dessertgabel Tenedor postre |
| 14 |  | Coltello frutta forgiato pesante Dessert knife-heavy forged Couteau à dessert forgé lourd Dessertmesser-schwer Cuchillo postre forjado pesado * |
| 15 |  | Coltello frutta forgiato Dessert knife-forged Couteau à dessert forgé Dessertmesser Cuchillo postre forjado * |
| 15R |  | Coltello frutta Reverse forgiato Dessert knife forged-Reverse Couteau à dessert Reverse forgé Dessertmesser Reverse Cuchillo postre Reverse forjado * |
| 16 |  | Coltello frutta leggero Dessert knife-light Couteau à dessert léger Dessertmesser-leicht Cuchillo postre ligero * |
| 18 |  | Coltello frutta m/v saldato Dessert knife-welded hollow-handle Couteau à dessert poignée creuse soudée Dessertmesser mit Hohlheft Cuchillo postre mango hueco soldado * |
| 21 |  | Cucchiaino caffè Tea spoon Cuillère à café Kaffeelöffel Cuchara café |
| 22 |  | Cucchiaino moka Moka spoon Cuillère à moka Mokkalöffel Cuchara moka |
| 23 |  | Cucchiaino zucchero Sugar spoon Cuillère à sucre Zuckerlöffel Cuchara azucar |
| 25 |  | Mestolo servire Soup ladle Louche Rührlöffel Cazo sopa |
| 26 |  | Forchettone servire Serving fork Fourchette à servir Vorgegabel Tenedor servir |
| 27 |  | Cucchiaino servire Serving spoon Cuillère à servir Vorlegelöffel Cucharón servir |
| 28 |  | Cucchiaino insalata Salad serving spoon Cuillère à servir salade Salatlöffel Cucharón servir ensalada |
| 29 |  | Forchettone insalata Salad serving fork Fourchette à servir salade Salatgabel Tenedor servir ensalada |
| 30 |  | Cucchiaino riso Rice-serving spoon Cuillère à riz Reislöffel Cucharón arroz |
| 31 |  | Forchetta pesce Fish fork Fourchette à poisson Fischgabel Tenedor pescado |
| 32 |  | Coltello pesce Fish knife Couteau à poisson Fischmesser Cuchillo pescado |
| 33 |  | Forchettone servire pesce Fish serving fork Fourchette à servir poisson Servierfischgabel Tenedor servir pescado |
| 34 |  | Coltello servire pesce Fish serving knife Couteau à servir poisson Servierfischmesser Cuchillo servir pescado |
| 35 |  | Cucchiaino bibita Ice tea spoon Cuillère à cocktail Cocktaillöffel Cuchara refresco |
| 37 |  | Paletta gelato Ice cream spoon Cuillère à glace Speiseeislöffel Cuchara helado |
| 38 |  | Forchettina dolce Cake fork Fourchette à tarte Kuchengabel Tenedor lunch |
| 39 |  | Pala dolce Cake server Pelle à tarte Tortenschaufel Pala pastel |
| 40 |  | Coltellone dolce Cake knife Gros couteau à tarte Tortenmesser Cuchillo pastel |
| 42 |  | Mestolino salsa Sauce ladle Louche à sauce Soßeschöpföffel Cacillo salsa |
| 43 |  | Spalmaburro Butter spreader Couteau à beurre Buttermesser Pala mantequilla |
| 45 |  | Spalmaburro Butter spreader Couteau à beurre Buttermesser Pala mantequilla |
| 53 |  | Spalmaburro forgiato Butter spreader - forged Couteau à beurre forgé Buttermesser Pala mantequilla forjado * |
| 55 |  | Coltello bistecca Steak knife Couteau à bifteck Filetmesser Cuchillo carne * |
| 63 |  | Forchetta lumache 2 punte 2 prongs snail fork Forchette à escargots à deux dents Zweizinkengabel für Schnecke Tenedor caracoles dos puntas |
| 64 |  | Forchettina ostriche Oyster fork Forchette à crustacés Auster Krustazeengabel Tenero mariscos |
| 67 |  | Cucchiaino salsa Sauce spoon Cuillère à sauce Soßelöffel Cuchara salsa |
| 80 |  | Cucchiaino lunch Lunch spoon Cuillère à lunch Lunchlöffel Cuchara lunch |

* materiale: acciaio inox | material: stainless steel |
matériel: acier Inoxydable | Material: aus Edelstahl | material: acero Inoxidable

Istruzioni d'uso e di manutenzione per la posateria e il vasellame in acciaio Inox

Lavare accuratamente i prodotti nuovi prima di utilizzarli. Utilizzare per il lavaggio acqua calda ed un buon sapone neutro, risciacquare in seguito con abbondante acqua tiepida ed asciugare scrupolosamente tutti gli articoli.

Non utilizzare per il lavaggio detersivi sintetici a base di cloro o prodotti comunque candeggianti.

Pomice, paglietta d'acciaio, spugnette o panni impregnati di polveri abrasive devono essere altresì rigorosamente esclusi. Possono invece essere utilizzati detersivi non clorurati contenente farina fossile.

E' consigliato il lavaggio degli articoli in acciaio Inox subito dopo il loro utilizzo. Qualora questo non fosse possibile è comunque importante non lasciare per più di 12 ore gli articoli sporchi a contatto con i residui alimentari (es: in caso di utilizzo degli articoli a pranzo, andrebbero lavati entro la sera del giorno stesso; in caso di utilizzo degli articoli a cena, andrebbero lavati entro la mattina del giorno seguente).

Nel caso fosse necessario un prelavaggio, questo deve essere fatto appena prima del lavaggio e per un tempo relativamente breve. Gli articoli non vanno infatti lasciati in ammollo nella soluzione lavante per troppo tempo in quanto alcune sostanze contenute negli alimenti sono dannose per l'acciaio Inox e ne alterano

l'aspetto. I coltelli e le lame dei coltelli (in caso di articolo a manico cavo) prodotte con un pregiato acciaio inox, sono sensibili agli attacchi corrosivi sviluppati dall'acido acetico, citrico, lattico ed in particolare da cloruro di sodio, presenti negli alimenti.

E' importante, sia in fase di prelavaggio che durante il lavaggio, tenere separate le normali posate (cucchiai, forchette, cucchiaini) dai coltelli e da altri oggetti metallici presenti in cucina.

Nel caso di lavaggio in lavastoviglie le posate devono essere inserite in cestelli verticali di plastica e tenute separate dai coltelli.

Asciugare accuratamente gli articoli con un panno morbido subito dopo il lavaggio, anche se il lavaggio è eseguito in lavastoviglie che prevede un ciclo di asciugatura automatica. Questo è necessario per evitare l'eventuale formazione di macchie dovute a depositi calcarei contenuti nell'acqua.

Non lasciare le posate nell'ambiente umido della lavastoviglie una volta terminato il ciclo di lavaggio, ma asciugarle e riporle in un ambiente asciutto.

Si consiglia di conservare gli articoli perfettamente asciutti, in un ambiente privo di umidità.

Per evitare rigature si consiglia di non conservare alla rinfusa gli articoli ma di riporli ordinatamente e proteggerli con un panno morbido.

Instructions for use and maintenance of stainless steel cutlery and hollowware

Wash the new products carefully before use.

Use hot water to wash them and a good neutral detergent; then, rinse out with lukewarm water and dry all the items thoroughly.

When washing, do not use chlorinated detergents nor products containing bleach.

Pumice, steel wool, sponges or cloths saturated with abrasive powders must be strictly avoided. However, detergents without chloride containing fossil flour can be used.

The washing of stainless steel items after use is recommended. In case that would not be possible, it is however important not to leave for more than 12 hours the dirty items in contact with food leftovers (e.g.: if the items are used at lunch, they should be washed within the evening; if the items are used at dinner, they should be washed within the following morning).

In case a prewash was needed, it must be carried out just before the washing and for a relatively short time. In fact, the items must not be soaked in the washing solution for too long, since some substances contained in food are damaging for the stainless steel and change its appearance. Knives and knife blades (for hollow

handle items) are manufactured with a valuable stainless steel and are sensitive to the corrosion attacks developed by acetic, citric and lactic acid and in particular to sodium chloride present in food.

It is important, both when pre-washing and washing, to keep cutlery like spoons, forks and tea spoons, separated from knives and other metal kitchenware.

In case of washing in dishwasher, spoons and forks must be placed into plastic vertical baskets and kept separated from knives.

Dry the items thoroughly immediately after the washing with a soft cloth, even if your dishwasher has a dry cycle.

That is necessary in order to avoid the possible formation of stains caused by calcareous deposits contained in the water.

Do not leave the cutlery in the humid environment of the dishwasher once the washing finishes; dry them and store them in a dry place.

It is recommended to store the items perfectly dried and in a location without humidity.

In order to avoid scratches, it is recommended not to keep the items randomly, but if it is possible, to protect them by soft cloth.





Luna

Inox 18/10 - St. Steel - 5 mm
Cod. CHP..



| COD. CHP.. | | L. mm |
|------------|--|-------|
| 01 | | 200 |
| 02 | | 202 |
| 05 | | 225 |
| 11 | | 193 |
| 12 | | 193 |
| 15 | | 212 |
| 21 | | 140 |
| 22 | | 106 |
| 38 | | 142 |

Amarcord

Inox 18/10 - St. Steel - 5mm
Cod. CC2..



COD. CC2..

L. mm

01  214

02  216

03  193

05  235

11  193

12  193

15  212

21  150

22  113

25  305

26  247

27  247

31  185

32  206

38  148

39  251

53  176

55  230



Milord

Inox 18/10 - St. Steel - 4 mm
Cod. C14..

| COD. C14.. | | L. mm |
|------------|--|-------|
| 01 | | 200 |
| 02 | | 200 |
| 03 | | 172 |
| 05 | | 230 |
| 08 | | 225 |
| 11 | | 177 |
| 12 | | 178 |
| 15 | | 195 |
| 18 | | 200 |
| 21 | | 133 |
| 22 | | 104 |
| 25 | | 310 |
| 26 | | 228 |
| 27 | | 227 |
| 28 | | 227 |
| 29 | | 225 |
| 30 | | 250 |
| 31 | | 198 |
| 32 | | 212 |
| 35 | | 195 |
| 36 | | 172 |
| 37 | | 129 |
| 38 | | 143 |
| 39 | | 240 |
| 42 | | 175 |
| 53 | | 168 |
| 55 | | 230 |
| 67 | | 184 |

Niagara

Inox 18/10 - St. Steel - 5 mm
Cod. CZ3..



COD. CZ3..

L. mm



210



210



231



181



183



210



142

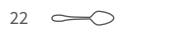

113



306



237



234



160



250



175



228













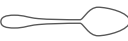

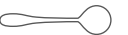

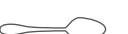

Dolce vita

Inox 18/10 - St. Steel - Forg.
Cod. CB8..



COD. CB8..

L. mm

| | | |
|----|---|-----|
| 01 |  | 205 |
| 02 |  | 210 |
| 03 |  | 214 |
| 05 |  | 235 |
| 11 |  | 193 |
| 12 |  | 193 |
| 15 |  | 212 |
| 21 |  | 150 |
| 22 |  | 113 |
| 25 |  | 305 |
| 26 |  | 247 |
| 27 |  | 247 |
| 31 |  | 186 |
| 32 |  | 203 |
| 38 |  | 148 |
| 39 |  | 251 |



Dream

Inox 18/10 - St. Steel - Forg.
Cod. CF9..















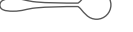





| COD. CF9.. | | L. mm |
|------------|--|-------|
| 01 | | 208 |
| 02 | | 208 |
| 05 | | 235 |
| 11 | | 187 |
| 12 | | 187 |
| 15 | | 210 |
| 21 | | 145 |
| 22 | | 115 |
| 26 | | 239 |
| 27 | | 239 |
| 30 | | 254 |
| 32 | | 198 |
| 38 | | 145 |
| 39 | | 248 |

Elegant

Inox 18/10 - St. Steel - 3,5 mm
Cod. CV6..



COD. CV6..

















- 01  208
- 02  208
- 03  185
- 05  240
- 05R  236
- 11  185
- 12  185
- 15  210
- 15R  204
- 21  142
- 22  114
- 25  314
- 26  231
- 27  229
- 31  182
- 32  197
- 38  145
- 39  240
- 53  175

L. mm



Relais

Inox 18/10 - St. Steel - 4 mm
Cod. CU3..

| COD. CU3.. | | L. mm |
|------------|---|-------|
| 01 |  | 210 |
| 02 |  | 210 |
| 03 |  | 185 |
| 05 |  | 235 |
| 11 |  | 187 |
| 12 |  | 192 |
| 15 |  | 212 |
| 21 |  | 135 |
| 22 |  | 112 |
| 25 |  | 305 |
| 26 |  | 240 |
| 27 |  | 240 |
| 31 |  | 185 |
| 32 |  | 197 |
| 38 |  | 143 |
| 39 |  | 247 |
| 53 |  | 176 |
| 55 | | 230 |

Ergo

Inox 18/10 - St. Steel - 4 mm
Cod. CE5..



COD. CE5..

L. mm

01  207

02  207

03  182

05  231

11  186

12  186

15  209

21  145

22  114

25  306

26  237

27  234

32  215

38  150

39  250

53  175













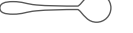



55  228



Ego

Inox 18/10 - St. Steel - 4 mm
Cod. CD3..













| COD. CD3.. | L. mm |
|--|-------|
| 01  | 207 |
| 02  | 207 |
| 03  | 182 |
| 05  | 231 |
| 11  | 186 |
| 12  | 186 |
| 15  | 209 |
| 21  | 145 |
| 22  | 114 |
| 25  | 306 |
| 26  | 237 |
| 27  | 234 |
| 30  | 278 |
| 32  | 215 |
| 38  | 150 |
| 39  | 250 |

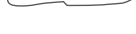

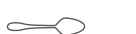
Slim

Inox 18/10 - St. Steel - 4 mm
Cod. CU7..



| COD. CU7.. | | L. mm |
|------------|---|-------|
| 01 |  | 202 |
| 02 |  | 202 |
| 03 |  | 193 |
| 05 |  | 235 |
| 11 |  | 193 |
| 12 |  | 193 |
| 15 |  | 212 |
| 21 |  | 150 |
| 22 |  | 113 |
| 32 |  | 214 |
| 38 |  | 148 |
| 53 |  | 176 |
| 55 |  | 230 |





Stilo

Inox 18/10 - St. Steel - 3 mm
Cod. CST..



| COD. CST.. | | L. mm |
|------------|--|-------|
| 01 | | 200 |
| 02 | | 200 |
| 03 | | 180 |
| 05 | | 230 |
| 11 | | 180 |
| 12 | | 180 |
| 15 | | 206 |
| 21 | | 141 |
| 22 | | 110 |
| 25 | | 295 |
| 26 | | 238 |
| 27 | | 238 |
| 28 | | 223 |
| 29 | | 221 |
| 30 | | 260 |
| 38 | | 242 |
| 39 | | 148 |
| 53 | | 165 |

Stilo

Black

Inox 18/10 - St. Steel - 3 mm
Cod. CST42..



COD. CST42..



200



200



230



141



110















Superior

Inox 18/10 - St. Steel - 4 mm
Cod. CZ4..



COD. CZ4..

L. mm

| | | |
|----|---|-----|
| 01 |  | 205 |
| 02 |  | 206 |
| 03 |  | 175 |
| 05 |  | 235 |
| 11 |  | 185 |
| 12 |  | 186 |
| 15 |  | 210 |
| 21 |  | 137 |
| 22 |  | 107 |
| 31 |  | 180 |
| 32 |  | 200 |
| 38 |  | 143 |

Neo

Inox 18/10 - St. Steel - 3 mm
Cod. CHU..



COD. CHU..

L. mm

01  210

02  210

03  180

05  232

11  190

12  190

15  207

21  148

22  114

25  305

26  239

27  239

32  215

38  147

39  251

53  175

55  219









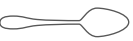

Clever

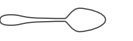
Inox 18/10 - St. Steel - 4 mm
Cod. CHG..



COD. CHG..

- 01  200
- 02  202
- 05  225
- 11  193
- 12  193
- 15  212
- 21  140
- 22  106
- 38  142

L. mm



Allegra

Inox 18/10 - St. Steel- 3 mm
Cod. CM6..

| COD. CM6.. | | L. mm |
|------------|--|-------|
| 01 | | 226 |
| 02 | | 226 |
| 05 | | 235 |
| 11 | | 180 |
| 12 | | 180 |
| 15 | | 203 |
| 21 | | 140 |
| 22 | | 106 |
| 38 | | 155 |
| 53 | | 176 |
| 55 | | 230 |

Dinamica

Inox 18/10 - St. Steel - 3 mm
Cod. CM7..



COD. CM7..

L. mm

01  210

02  213

05  235

11  190

12  180

15  210

21  133

22  110

25  290

26  241

27  241

31  206

32  213













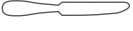

38  160

39  241



Style

Inox 18/10 - St. Steel - 3 mm
Cod. CD6..

| COD. CD6.. | | L. mm |
|------------|---|-------|
| 01 |  | 202 |
| 02 |  | 202 |
| 03 |  | 180 |
| 05 |  | 230 |
| 11 |  | 182 |
| 12 |  | 182 |
| 15 |  | 208 |
| 21 |  | 140 |
| 22 |  | 108 |
| 25 |  | 310 |
| 26 |  | 232 |
| 27 |  | 233 |
| 32 |  | 201 |
| 35 |  | 195 |
| 38 |  | 146 |
| 39 |  | 246 |

Linea

Inox 18/10 - St. Steel - 3 mm
Cod. CF7..



COD. CF7..

L. mm



215



220



235



195,5



210



155



116



305



255



258



212



155











239

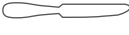
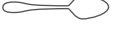

Gourmet

Inox 18/10 - St. Steel - 3 mm
Cod. CF5..

| COD. CF5.. | | L. mm |
|------------|---|-------|
| 01 |  | 197 |
| 02 |  | 197 |
| 03 |  | 172 |
| 05 |  | 227 |
| 11 |  | 195 |
| 12 |  | 177 |
| 15 |  | 202 |
| 21 |  | 131 |
| 22 |  | 103 |
| 38 |  | 153 |
| 55 |  | 219 |





Step





















Inox 18/10 - St. Steel - 3 mm
Cod. CF8..

| COD. CF8.. | | L. mm |
|------------|--|-------|
| 01 | | 200 |
| 02 | | 202 |
| 03 | | 178 |
| 05 | | 226 |
| 11 | | 179 |
| 12 | | 181 |
| 15 | | 207 |
| 21 | | 140 |
| 22 | | 109,7 |
| 25 | | 290 |
| 26 | | 231 |
| 27 | | 234 |
| 30 | | 260 |
| 31 | | 180 |
| 32 | | 193 |
| 38 | | 146 |
| 39 | | 255 |
| 53 | | 170 |

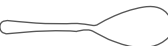
Marea

Inox 18/10 - St. Steel - 3 mm
Cod. CE4..

COD. CE4..

- 01  200
- 02  200
- 03  169
- 05  235
- 11  173
- 12  175
- 15  210
- 21  134
- 22  117
- 25  285
- 26  232
- 27  230
- 28  230
- 29  225
- 30  260
- 32  202
- 35  210
- 38  155
- 39  249
- 42  150
- 53  175

L. mm









Marea

Polvere di Luna - Moondust

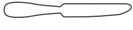
Inox 18/10 - St. Steel - 3 mm
Cod. CE432 ..

| COD. CE432.. | | L. mm |
|--------------|---|-------|
| 01 |  | 200 |
| 02 |  | 200 |
| 05 |  | 235 |
| 21 |  | 134 |
| 22 |  | 117 |

Mirage

Inox 18/10 - St. Steel - 2,5 mm
Cod. C17..

COD. C17..

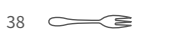
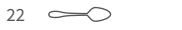

L. mm

200

200

170

223

223

178

179

199

135

110

314

230

229

203

222

210

159

247

210













Buffet

Vintage

Inox 18/10 - St. Steel- 2 mm
Cod. CD551..C

COD. CD551..C

L. mm

| | | |
|----|---|-----|
| 01 |  | 199 |
| 02 |  | 201 |
| 05 |  | 231 |
| 11 |  | 178 |
| 12 |  | 178 |
| 15 |  | 208 |
| 21 |  | 140 |
| 22 |  | 105 |
| 38 |  | 145 |









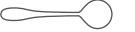

Infinito

Inox 18/10 - St. Steel- 2,5 mm
Cod. CV7..



COD. CV7..

L. mm





- 01  205
- 02  205
- 03  182
- 05  231
- 11  186
- 12  186
- 15  209
- 21  145
- 22  114
- 38  150



Infinito

Copper

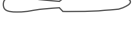
Inox 18/10 - St. Steel- 2,5 mm
Cod. CV740..

| COD. CV740.. | | L. mm |
|--------------|---|-------|
| 01 |  | 205 |
| 02 |  | 205 |
| 05 |  | 231 |
| 21 |  | 145 |
| 22 |  | 114 |

Infinito

Vintage

Inox 18/10 - St. Steel- 2,5 mm
Cod. CV751..



COD. CV751..

L. mm



205



205



182



231



186



186

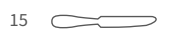

209

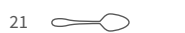

145

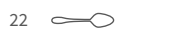

114













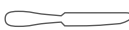
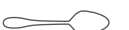







150

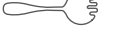

Baltic

Inox 18/10 - St. Steel - 2,5 mm
Cod. CB6..

| COD. CB6.. | | L. mm |
|------------|---|-------|
| 01 |  | 195 |
| 02 |  | 197 |
| 05 |  | 216 |
| 11 |  | 181 |
| 12 |  | 176 |
| 15 |  | 192 |
| 21 |  | 134 |
| 22 |  | 105 |
| 25 |  | 307 |
| 26 |  | 233 |
| 27 |  | 232 |
| 28 |  | 223 |
| 29 |  | 221 |
| 31 |  | 207 |
| 32 |  | 208 |
| 35 |  | 209 |
| 38 |  | 140 |
| 39 |  | 244 |
| 63 |  | 158 |

Baltic Abi

Inox 18/10 - St. Steel - 2,5 mm
Cod. CB6S..



COD. CB6S..

L. mm



195



195



216











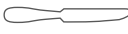
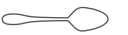

134

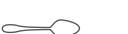

Monaco

Inox 18/10 - St. Steel - 2,5 mm
Cod. C34..

| COD. C34.. | | L. mm |
|------------|---|-------|
| 01 |  | 196 |
| 02 |  | 195 |
| 05 |  | 218 |
| 11 |  | 170 |
| 12 |  | 173 |
| 15 |  | 190 |
| 21 |  | 131 |
| 22 |  | 110 |
| 27 |  | 223 |
| 32 |  | 205 |
| 38 |  | 155 |
| 39 |  | 238 |
| 42 |  | 158 |











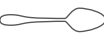

Flair

Inox 18/10 - St. Steel - 2,5 mm
Cod. C02..



COD. C02..

L. mm

| | | |
|----|---|-----|
| 01 |  | 202 |
| 02 |  | 202 |
| 05 |  | 222 |
| 11 |  | 178 |
| 12 |  | 179 |
| 15 |  | 199 |
| 21 |  | 135 |
| 22 |  | 110 |
| 31 |  | 203 |
| 32 |  | 222 |
| 38 |  | 159 |
| 39 |  | 247 |
| 53 |  | 175 |
| 55 |  | 220 |



Matisse

Inox 18/10 - St. Steel - 2,5 mm
Cod. CF1..

| COD. CF1.. | | L. mm |
|------------|--|-------|
| 01 | | 204 |
| 02 | | 205 |
| 03 | | 168 |
| 05 | | 238 |
| 11 | | 178 |
| 12 | | 178 |
| 15 | | 208 |
| 21 | | 137 |
| 22 | | 110 |
| 25 | | 295 |
| 26 | | 240 |
| 27 | | 237 |
| 31 | | 203 |
| 32 | | 210 |
| 35 | | 207 |
| 37 | | 133 |
| 38 | | 153 |
| 39 | | 238 |
| 42 | | 170 |
| 53 | | 178 |
| 55 | | 230 |
| 63 | | 156 |
| 64 | | 156 |
| 80 | | 158 |

Matisse

Vintage

Inox 18/10 - St. Steel - 2,5 mm
Cod. CF151..

COD. CF151..



L. mm

204



205



168



230



178



178



208



137

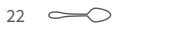

110



295



240



237



203



210



207

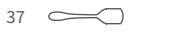

133



153



238



178



230



156



156

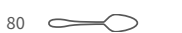

158





Matisse

Vintage Gold

Inox 18/10 - St. Steel - 2,5 mm
Cod. CF157..



COD. CF157..

L. mm



204



205



230



137







110



Matisse

Vintage Copper

Inox 18/10 - St. Steel - 2,5 mm
Cod. CF156..

| COD. CF156.. | | L. mm |
|--------------|---|-------|
| 01 |  | 204 |
| 02 |  | 205 |
| 05 |  | 230 |
| 21 |  | 137 |
| 22 |  | 110 |

Cosmos

Inox 18/10 - St. Steel - 2,5 mm
Cod. C06..



COD. C06..

01  197

02  199

05  213

11  177

12  179

15  200

21  130

22  108

25  305

26  230

27  225

35  197















38  150

L. mm



Brigitte

Inox 18/10 - St. Steel - 2 mm
Cod. C68..

| COD. C68.. | | L. mm |
|------------|---|-------|
| 01 |  | 195 |
| 02 |  | 197 |
| 06 |  | 213 |
| 21 |  | 131 |
| 22 |  | 103 |
| 25 |  | 315 |
| 26 |  | 230 |
| 27 |  | 226 |
| 31 |  | 190 |
| 32 |  | 210 |
| 35 |  | 207 |
| 38 |  | 153 |
| 39 |  | 240 |
| 42 |  | 170 |

Naif

Inox 18/10 - St. Steel - 1,8 mm
Cod. CE8..



COD. CE8..

L. mm



200



202



222



136











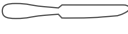
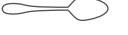

155



Mare

Acciaio Inox - St. Steel - 3 mm
Cod. CN8..

| COD. CN8.. | | L. mm |
|------------|---|-------|
| 01 |  | 202 |
| 02 |  | 202 |
| 05 |  | 222 |
| 11 |  | 173 |
| 12 |  | 175 |
| 15 |  | 191 |
| 21 |  | 134 |
| 22 |  | 117 |
| 38 |  | 155 |
| 53 |  | 175 |
| 80 |  | 144 |





Med

Acciaio Inox - St. Steel - 2,2 mm
Cod. CT1..

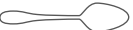

COD. CT1..

L. mm





- 01  204
- 02  205
- 05  230
- 21  137



Tattoo

Polvere di Luna - Moondust

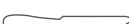
Inox 18/10 - St. Steel- 2 mm
Cod. CD5TA32..

| COD. CD5TA32.. | | L. mm |
|----------------|---|-------|
| 01 |  | 198 |
| 02 |  | 200 |
| 05 |  | 230 |
| 21 |  | 132 |
| 38 |  | 154 |

Tattoo

Inox 18/10 - St. Steel- 2 mm
Cod. CD5TA..



COD. CD5TA..



L. mm

198



200



230



132



154



Tattoo

Copper

Inox 18/10 - St. Steel- 2 mm
Cod. CD5TA40..



COD. CD5TA40..

L. mm



198



200



230



132







154



Tattoo

Gold

Inox 18/10 - St. Steel- 2 mm
Cod. CD5TA41..

| COD. CD5TA41.. | | L. mm |
|----------------|---|-------|
| 01 |  | 198 |
| 02 |  | 200 |
| 05 |  | 230 |
| 21 |  | 132 |
| 38 |  | 154 |

Rinascimento

Inox 18/10 - St. Steel - 3 mm
Cod. CHA..



| COD. CHA.. | L. mm |
|------------|-------|
| 01 | 198 |
| 02 | 200 |
| 03 | 170 |
| 05 | 235 |
| 11 | 176 |
| 12 | 179 |
| 15 | 210 |
| 21 | 133 |
| 22 | 107 |
| 25 | 315 |
| 26 | 239 |
| 27 | 239 |
| 31 | 186 |
| 32 | 210 |
| 38 | 154 |
| 39 | 240 |
| 53 | 170 |



Rada

Inox 18/10 - St. Steel - 3 mm
Cod. C29..

COD. C29..

L. mm



208



206



175



236



230



235



187



187



216



210



215



142



141



300



227



225



182



201



139



152



142



240



160



174



220





Splendido

Inox 18/10 - St. Steel - 3,5 mm
Cod. C19..

| COD. C19.. | | L. mm |
|------------|--|-------|
| 01 | | 201 |
| 02 | | 200 |
| 03 | | 178 |
| 05 | | 237 |
| 11 | | 180 |
| 12 | | 180 |
| 15 | | 201 |
| 21 | | 140 |
| 22 | | 106 |
| 25 | | 303 |
| 26 | | 230 |
| 27 | | 229 |
| 31 | | 200 |
| 32 | | 214 |
| 38 | | 148 |
| 39 | | 242 |
| 43 | | 170 |



aberit



Imperial

Inox 18/10 - St. Steel - 3 mm
Cod. C04..

| COD. C04.. | | L. mm |
|------------|--|-------|
| 01 | | 207 |
| 02 | | 208 |
| 03 | | 174 |
| 05 | | 246 |
| 08 | | 247 |
| 11 | | 187 |
| 12 | | 188 |
| 15 | | 216 |
| 18 | | 214 |
| 21 | | 141 |
| 22 | | 111 |
| 23 | | 116 |
| 25 | | 315 |
| 26 | | 239 |
| 27 | | 239 |
| 28 | | 206 |
| 29 | | 205 |
| 31 | | 186 |
| 32 | | 210 |
| 33 | | 242 |
| 34 | | 260 |
| 35 | | 192 |
| 36 | | 174 |
| 37 | | 133 |
| 38 | | 145 |
| 39 | | 240 |
| 40 | | 255 |
| 42 | | 164 |
| 53 | | 170 |
| 55 | | 220 |













Perla

Inox 18/10 - St. Steel - 3 mm
Cod. CZ1..



COD. CZ1..













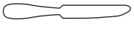
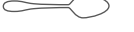



L. mm

| | | |
|----|---|-----|
| 01 |  | 200 |
| 02 |  | 201 |
| 03 |  | 176 |
| 05 |  | 228 |
| 11 |  | 180 |
| 12 |  | 180 |
| 15 |  | 204 |
| 21 |  | 140 |
| 22 |  | 104 |
| 31 |  | 197 |
| 32 |  | 208 |
| 38 |  | 152 |

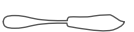

Vintage

Inox 18/10 - St. Steel - 3 mm
Cod. CB5..













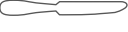







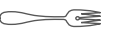

| COD. CB5.. | | L. mm |
|------------|---|-------|
| 01 |  | 205 |
| 02 |  | 206 |
| 05 |  | 230 |
| 11 |  | 187 |
| 12 |  | 187 |
| 15 |  | 206 |
| 21 |  | 142 |
| 22 |  | 117 |
| 25 |  | 300 |
| 26 |  | 227 |
| 27 |  | 225 |
| 31 |  | 181 |
| 32 |  | 202 |
| 38 |  | 152 |
| 39 |  | 242 |
| 40 |  | 237 |
| 55 |  | 203 |

Baguette

Inox 18/10 - St. Steel - 2,5 mm
Cod. CP1..

COD. CP1..

L. mm

| | | |
|----|---|-----|
| 01 |  | 205 |
| 02 |  | 205 |
| 03 |  | 169 |
| 05 |  | 250 |
| 08 |  | 225 |
| 11 |  | 179 |
| 12 |  | 179 |
| 15 |  | 195 |
| 18 |  | 200 |
| 21 |  | 143 |
| 22 |  | 110 |
| 25 |  | 295 |
| 26 |  | 239 |
| 27 |  | 236 |
| 31 |  | 205 |
| 32 |  | 211 |
| 35 |  | 207 |
| 37 |  | 133 |
| 38 |  | 154 |
| 39 |  | 238 |
| 45 |  | 178 |
| 53 |  | 175 |
| 55 |  | 212 |
| 67 |  | 179 |





HAGE

Silvia

Inox 18/10 - St. Steel - 2,5 mm
Cod. CP7..



COD. CP7..

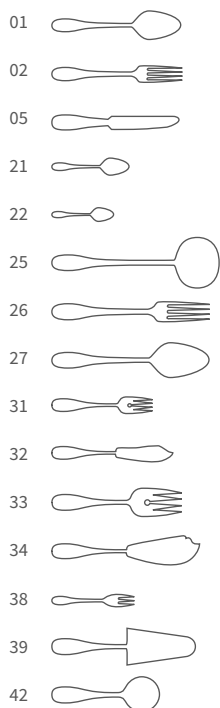















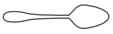







L. mm

- 206
- 204
- 238
- 139
- 112
- 292
- 227
- 227
- 181
- 205
- 221
- 241
- 150
- 268
- 183

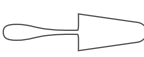

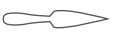
Victory

Inox 18/10 - St. Steel - 2,5 mm
Cod. CP2..

| COD. CP2.. | | L. mm |
|------------|---|-------|
| 01 |  | 205 |
| 02 |  | 205 |
| 03 |  | 167 |
| 05 |  | 230 |
| 11 |  | 178 |
| 12 |  | 179 |
| 15 |  | 208 |
| 21 |  | 137 |
| 22 |  | 110 |
| 25 |  | 299 |
| 26 |  | 239 |
| 27 |  | 236 |
| 31 |  | 203 |
| 32 |  | 210 |
| 35 |  | 206 |
| 37 |  | 132 |
| 38 |  | 153 |
| 39 |  | 235 |
| 42 |  | 170 |
| 45 |  | 176 |
| 53 |  | 170 |
| 55 |  | 227 |
| 80 |  | 160 |

Enrico VIII

Inox 18/10 - St. Steel - 2,5 mm
Cod. CUB..



COD. CUB..

L. mm



203



204



168



235



186



184

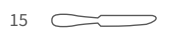

200

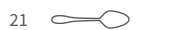

137

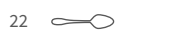

121



182



193













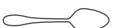

142











Alaska

Inox 18/10 - St. Steel - 2,5 mm
Cod. C24..

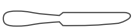
| COD. C24.. | | L. mm |
|------------|---|-------|
| 01 |  | 195 |
| 02 |  | 195 |
| 05 |  | 212 |
| 06 |  | 212 |
| 11 |  | 175 |
| 12 |  | 176 |
| 15 |  | 190 |
| 21 |  | 137 |
| 22 |  | 103 |
| 38 |  | 152 |
| 39 |  | 224 |
| 40 |  | 223 |
| 42 |  | 175 |

Alaska Inox

Inox 18/CR - St. Steel - 1,8 mm
Cod. CG3..

| COD. CG3.. | | L. mm |
|------------|---|-------|
| 01 |  | 195 |
| 02 |  | 195 |
| *06 |  | 212 |
| 21 |  | 128 |
| 22 |  | 117 |
| 35 |  | 208 |
| 37 |  | 134 |
| 38 |  | 175 |

*C2406











England

Inox 18/10 - St. Steel - 2,2 mm
Cod. C97RO..



COD. C97RO..

L. mm

- 01  203
- 02  201
- 05  218
- 11  180
- 12  180
- 15  203
- 21  140
- 22  106
- 35  192
- 38  144
- 39  245



Verve

Inox 18/10 - St. Steel - 1,8 mm
Cod. C37..







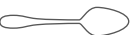

| COD. C37.. | | L. mm |
|------------|--|-------|
| 01 | | 200 |
| 02 | | 204 |
| 03 | | 166 |
| 05 | | 230 |
| 06 | | 232 |
| 21 | | 140 |
| 22 | | 105 |
| 38 | | 145 |

Scozia

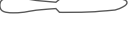
Inox 18/CR - St. Steel - 3,0 mm
Cod. CN6..



COD. CN6..



















- 01  200
- 02  200
- 05  222
- 11  180
- 12  180
- 15  203
- 21  138
- 22  105
- 38  143

L. mm

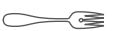

Boston

Inox 18/10 - St. Steel - 2,5 mm
 Manico satinato - Mat finishing handle
 Cod. C39..







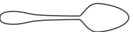

| COD. C39.. | | L. mm |
|------------|---|-------|
| 01 |  | 195 |
| 02 |  | 196 |
| 05 |  | 210 |
| 11 |  | 173 |
| 12 |  | 177 |
| 15 |  | 192 |
| 21 |  | 132 |
| 22 |  | 116 |
| 25 |  | 308 |
| 26 |  | 225 |
| 27 |  | 222 |
| 28 |  | 203 |
| 29 |  | 205 |
| 31 |  | 190 |
| 32 |  | 204 |
| 35 |  | 206 |
| 37 |  | 131 |
| 38 |  | 153 |

Firenze

Inox 18/10 - St. Steel - 2,5 mm
Cod. C84..



COD. C84..

- 01 
- 02 
- 05 
- 11 
- 12 
- 15 
- 21 
- 22 
- 38 









L. mm

- 195
- 196
- 210
- 173
- 175
- 194
- 132
- 116
- 152

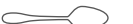

River

Inox 18/10 - St. Steel - 2,2 mm
Cod. CV9..







| COD. CV9.. | | L. mm |
|------------|---|-------|
| 01 |  | 195 |
| 02 |  | 194 |
| 05 |  | 222 |
| 11 |  | 172 |
| 12 |  | 174 |
| 15 |  | 191 |
| 21 |  | 129 |
| 22 |  | 111 |
| 38 |  | 153 |











Blade

Inox 18/10 - St. Steel - 1,8 mm
Cod. CHM..

| COD. CHM.. | | L. mm |
|------------|---|-------|
| 01 |  | 200 |
| 02 |  | 200 |
| 06 |  | 225 |
| 21 |  | 141 |
| 22 |  | 105 |
| 38 |  | 142 |







Blade Inox

Inox 18/CR - St. Steel - 1,8 mm
Cod. CHL..

| COD. CHL.. | | L. mm |
|------------|---|-------|
| 01 |  | 200 |
| 02 |  | 200 |
| 06 |  | 220 |
| 21 |  | 141 |
| 22 |  | 105 |
| 38 |  | 141 |







Wave/A

Inox 18/10 - St. Steel - 1,8 mm
Cod. CHF..

| COD. CHF.. | L. mm |
|--|-------|
| 01  | 200 |
| 02  | 202 |
| 06  | 218 |
| 21  | 140 |
| 22  | 116 |
| 35  | 207 |
| 38  | 142 |

Wave/A Inox

Inox 18/CR - St. Steel - 1,8 mm
Cod. CHD..

| COD. CHD.. | L. mm |
|--|-------|
| 01  | 200 |
| 02  | 202 |
| 06  | 220 |
| 21  | 140 |
| 22  | 106 |
| 35  | 207 |
| 38  | 142 |





Mox











Rimini

Inox 18/10 - St. Steel - 2 mm
 Manico satinato - Mat finishing handle
 Cod. C45..



COD. C45..

L. mm

| | |
|----|---|
| 01 |  |
| 02 |  |
| 05 |  |
| 11 |  |
| 12 |  |
| 15 |  |
| 21 |  |
| 22 |  |
| 37 |  |
| 38 |  |

195

194

231

172

174

191

129

111









135

153



Toronto Inox

Inox 18/CR - St. Steel - 1,8 mm
Cod. CG8..

| COD. CG8.. | | L. mm |
|------------|---|-------|
| 01 |  | 195 |
| 02 |  | 196 |
| * 05 |  | 209 |
| 21 |  | 132 |
| 22 |  | 116 |
| 35 |  | 206 |
| 37 |  | 131 |
| 38 |  | 153 |

*CH805

Euro

Inox 18/10 - St. Steel - 2 mm
Cod. CR3MH..



COD. CR3MH..



197



193



222



131



116

Valencia

Inox 18/10 - St. Steel - 1,8 mm
Cod. CR9..



| COD. CR9.. | | L. mm |
|------------|--|-------|
| 01 | | 195 |
| 02 | | 198 |
| 03 | | 169 |
| 05 | | 215 |
| 06 | | 215 |
| 11 | | 177 |
| 12 | | 179 |
| 15 | | 209 |
| 16 | | 192 |
| 21 | | 138 |
| 22 | | 110 |
| 25 | | 298 |
| 26 | | 240 |
| 27 | | 236 |
| 31 | | 198 |
| 32 | | 201 |
| 35 | | 207 |
| 37 | | 135 |
| 38 | | 154 |

Valencia Inox







Inox 18/CR - St. Steel - 1,8 mm
Cod. CG2..

| COD. CG2.. | | L. mm |
|------------|--|-------|
| 01 | | 195 |
| 02 | | 198 |
| * 06 | | 215 |
| 11 | | 177 |
| * 16 | | 192 |
| 21 | | 138 |
| 22 | | 110 |
| 35 | | 207 |
| 37 | | 135 |
| 38 | | 154 |
| 80 | | 215 |

*CR906

Murano







Inox 18/10 - St. Steel - 1,8 mm
Cod. CD5..

| COD. CD5.. | | L. mm |
|------------|---|-------|
| 01 |  | 199 |
| 02 |  | 201 |
| 06 |  | 213 |
| 21 |  | 140 |
| 22 |  | 105 |
| 38 |  | 145 |



Murano Inox

Inox 18/CR - St. Steel - 1,8 mm
Cod. CG5..









| COD. CG5.. | | L. mm |
|------------|---|-------|
| 01 |  | 199 |
| 02 |  | 201 |
| * 06 |  | 211 |
| 21 |  | 140 |
| 22 |  | 105 |
| 35 |  | 187 |
| 38 |  | 145 |

*CD506

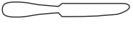
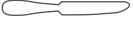

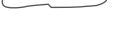
Corona

Inox 18/10 - St. Steel - 1,8 mm
Cod. CS0..

| COD. CS0.. | | L. mm |
|------------|---|-------|
| 01 |  | 195 |
| 02 |  | 198 |
| 05 |  | 223 |
| 06 |  | 215 |
| 12 |  | 179 |
| 15 |  | 207 |
| 21 |  | 138 |
| 22 |  | 110 |
| 38 |  | 154 |







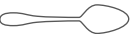

Oslo

Inox 18/CR - St. Steel - 2 mm
 Manico satinato - Mat finishing handle
 cod. C49..

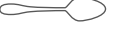

COD. C49..









L. mm

- 01  194
- 02  192
- 05  210
- 11  174
- 12  177
- 15  190
- 21  127
- 22  113
- 38  151

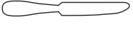
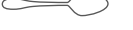
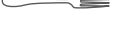

Luisa

Inox 18/10 - St. Steel - 1,8 mm
Cod. CS4..

| COD. CS4.. | | L. mm |
|------------|---|-------|
| 01 |  | 193 |
| 02 |  | 196 |
| 06 |  | 222 |
| 11 |  | 179 |
| 12 |  | 180 |
| 16 |  | 190 |
| 21 |  | 130 |
| 22 |  | 124 |
| 35 |  | 187 |
| 38 |  | 145 |

Corsaro

Inox 18/CR - St. Steel - 1,5 mm
Cod. CV1..



COD. CV1..

L. mm



195



195



210



130



103











159



Eva

Inox 18/CR - St. Steel - 1,5 mm
Cod. CT4E..

| COD. CT4E.. | | L. mm |
|-------------|---|-------|
| 01 |  | 194 |
| 02 |  | 193 |
| 06 |  | 213 |
| 21 |  | 129 |
| 22 |  | 110 |
| 35 |  | 207 |
| 37 |  | 134 |
| 38 |  | 154 |

America

Inox 18/CR - St. Steel - 1,5 mm
Cod. C46..



COD. C46..

L. mm



193



193



212



173



170



120



102



141



Murano con appendino

with hanger Inox 18/CR - St. Steel - 2,2 mm





Cod. CN4..

Cod. APPCOSN



COD. C46..

L. mm

| | | |
|----|---|-----|
| 01 |  | 199 |
| 02 |  | 201 |
| 05 |  | 230 |
| 21 |  | 131 |
| 38 |  | 150 |

Bivalva Roberta

Roberta blister
Blister Roberta
Sichtbare Blase
Blister Roberta

Acciaio Inox - St. Steel **L.mm**

| | | |
|-------------------|-------------------|-----|
| Cucchiaino tavola | F85 22 401 pcs 24 | 190 |
| Forchetta tavola | F85 22 402 pcs 24 | 190 |
| Coltello tavola | F85 21 205 pcs 12 | 213 |
| Cucchiaino caffè | F85 24 821 pcs 48 | 120 |
| Forchetta dolce | F85 23 638 pcs 36 | 150 |



Bivalva Svezia

Svezia blister
Blister Svezia
Sichtbare Blase
Blister Svezia

Acciaio Inox - St. Steel**L. mm**

| | | pcs | L. mm |
|-------------------|----------|-----|-------|
| Cucchiaino bibita | FSV21835 | 18 | 204 |
| Palette gelato | FSV21837 | 18 | 131 |
| Forchettina dolce | FSV22438 | 24 | 145 |
| Cucchiaino caffè | FSV23021 | 30 | 140 |
| Cucchiaino moka | FSV23622 | 36 | 105 |



PRO
SATA
TTE
RIA

FINITURE SPECIALI

Finiture di tendenza e nuances raffinate che suscitano nuove sensazioni, trasmettono stile e personalizzano la mise en place.

Trendy finishes and refined nuances that arouse new sensations, convey style and personalise the mise-en-place.

Finitions de tendance et nuances raffinées qui donnent des sensations nouvelles, en transmettant style et en personnalisant la mise en place des tables.

Acabados de tendencia y tonos refinados que provocan nuevas sensaciones, transmiten estilo y personalizan la mise en place.

Trendige Oberflächen und raffinierte Nuancen, die neue Empfindungen wecken, Stil vermitteln und das Mise en Place personalisieren.

FINITURE SPECIALI - SPECIAL FINISH

Vintage

L'opacità, i graffi ed i segni volutamente prodotti sulla superficie delle posate con finitura Vintage danno la sensazione di oggetti vissuti ed utilizzati a lungo, di grandi cucine profumate, calde e piene di vapore, di convivialità di altri tempi, di sapori antichi. Evocano immagini di ambienti tradizionali, rustici e senza pretese di modernità.

Opacity, scratches and marks intentionally made on the surface of the cutlery with a Vintage finish give the effect of objects that have been used for a long time, of a large, warm and steamy kitchen filled with aromas, of the friendly gatherings of old good times and ancient flavours. They evoke images of traditional, simple environments with no intention to be modern.

L'opacité, les égratignures et les marques intentionnellement produites sur la surface des couverts à finition Vintage donnent le sentiment d'objets vécus et utilisés depuis longtemps, de grandes cuisines odorantes, chaudes et pleines de vapeur, de convivialité d'autrefois, de saveurs d'antan. Elles évoquent des images de lieux traditionnels, rustiques et sans prétention de modernité.

La opacidad, los rasguños y las marcas producidos deliberadamente en la superficie de los cubiertos con acabado Vintage dan la sensación de objetos vividos y utilizados por largo tiempo, de grandes cocinas perfumadas, cálidas y llenas de vapor, de convivialidad de otros tiempos, de sabores antiguos. Evocando imágenes de ambientes tradicionales, rústicos y sin pretensiones de modernidad.

Der Mattglanz, die "Kratzer" und gezielt in die Oberfläche eingearbeiteten Zeichen der Serie 'Vintage' verleihen diesem Besteck einen besonders raffinierten Look von seit langem benutzten Gegenständen, erinnern an die Atmosphäre großer gemütlicher Wohnküchen von früher, wo es herrlich nach den Gerichten unserer Kindheit duftete. Sie rufen Bilder traditioneller Ambiente wach, ohne dem Anspruch moderner Stilformen nachzugeben.

Polvere di Luna

La finitura Polvere di Luna rende l'aspetto delle posate satinato e delicatamente brillante: una superficie levigata con chiaroscuri. Piacevoli e vellutate al tatto, trasmettono una morbidezza ed un calore inconsueto per oggetti di acciaio. Un rivestimento sobrio ed inusuale per posate contemporanee.

The Polvere di Luna finish makes cutlery surface look satin-like and delicately brilliant: a smooth surface with contrasting shades. Pleasant and velvety to the touch, the cutlery so treated convey a softness and warmth unusual for steel objects. A sober and unusual coating for contemporary cutlery.

La finition Polvere di Luna rend l'aspect des couverts satiné et délicatement brillant : une surface polie avec des clairs-obscur. Agréables et veloutées au toucher, ils transmettent une douceur et une chaleur insolites pour des objets en acier. Un revêtement sobre et inusuel pour des couverts contemporains.

El acabado Polvere di Luna confiere a los cubiertos un aspecto satinado y delicadamente brillante: una superficie pulida con claroscuros. Agradables y aterciopelados al tacto, transmiten una suavidad y una calidez insólitas en objetos de acero. Un revestimiento sobrio e inusual para cubiertos contemporáneos.

Die Oberflächenbearbeitung 'Polvere di Luna' verleiht dem Besteck samt dem Glanz mit edlen hell-dunkel Schattierungen. Von ausgesprochen gepflegter Haptik, liegt dieses Besteck weich und besonders angenehm in der Hand und strahlt eine für Stahl ungewöhnliche Wärme aus. Ein dezentes und einzigartiges Oberflächenfinish für zeitgenössisches Besteck.

Scotch-Brite

Questo effetto superficiale, tipicamente utilizzato nell'architettura di interni, è caratterizzato dalla presenza di molteplici e lievissime graffiature longitudinali; dona al metallo una sembianza velata e luminosa al tempo stesso, conferendo agli oggetti che riveste un aspetto di brillantezza pacata, di acciaio non lucente. Per utensili che evocano il design di stile nordico.

This superficial effect, typically used in the interior architecture, is characterized by the presence of numerous and very light longitudinal scratches; it adds to the metal a veiled and bright appearance at the same time, bestowing to the objects it covers an aspect of measured brilliance, of non-glowing steel. For tools that evoke northern design.

Cet effet de surface, typiquement utilisé dans l'architecture d'intérieur, se caractérise par la présence de plusieurs et très légères éraflures longitudinales; cela rend le métal d'une apparence voilée et lumineuse en même temps, en donnant aux objets un aspect d'éclat paisible, d'acier pas brillant. Pour outils qui évoquent le design du style nordique.

Este efecto superficial, típicamente utilizado en la arquitectura de interiores, se caracteriza por la presencia de múltiples rasguños longitudinales; proporciona al metal una apariencia velada y luminosa al mismo tiempo, otorgando a los objetos que cubre un aspecto de brillo sosegado, de acero no reluciente. Para utensilios que evocan diseño de estilo nórdico.

Dieser Oberflächeneffekt, der typischerweise in der Innenarchitektur verwendet wird, charakterisiert sich für das Vorhandensein mehrerer und sehr geringer Längskratzer. Es verleiht dem Metall gleichzeitig einen verschleihten und leuchtenden Anschein und verleiht den Objekten, die es abdeckt, einen Aspekt ruhiger Brillanz und nicht glänzenden Stahls. Scotch-brite ist ideal für Werkzeuge, die an das nordische Design erinnern.



Polvere di Luna

Moon Dust
Cod. ...32



Finitura disponibile per tutti i modelli

Finish available for all models

Non disponibile per posate a manico cavo

Not available for hollow-handle cutlery

Minimo di ordine 500 pz assortiti

500 assorted pcs minimum order



Vintage

Vintage
Cod. ...51

Finitura disponibile per tutti i modelli
Finish available for all models

Non disponibile per posate a manico cavo
Not available for hollow-handle cutlery

Minimo di ordine 500 pz assortiti
500 assorted pcs minimum order

Scotch-Brite

Inox Scotch Brite
Cod. ...73



Finitura disponibile per tutti i modelli

Finish available for all models

Non disponibile per posate in PVD

Not available in PVD cutlery

Minimo di ordine 500 pz assortiti

500 assorted pcs minimum order

PVD

The PVD (Physical Vapour Deposition) technique allows to deposit a high-thickness metal film with remarkable characteristics from the decorative and technical point of view. Such process makes the product treated durable in time and gives high surface hardness. The item turns resistant to solvents, acids and to various products used in the kitchen, keeping its chemical/physical characteristics unchanged. It is a thoroughly biocompatible, anallergic treatment and suitable for food contact.

La technique PVD (Physical Vapour Deposition) permet de déposer un film métallique de haute épaisseur avec des caractéristiques surprenantes du point de vue décoratif et technique. Ce processus rend le produit traité durable et confère une dureté superficielle élevée. L'article devient résistant aux solvants, aux acides et aux différents produits employés en cuisine, gardant intactes ses propres caractéristiques chimio/physiques. C'est un traitement absolument biocompatible, anallergique et approprié au contact avec la nourriture.

La técnica PVD (Physical Vapour Deposition) permite depositar una película metálica de alto grosor con características sorprendentes desde el punto de vista decorativo y técnico. Este procedimiento hace que el producto tratado sea duradero en el tiempo y le

confiere una elevada dureza superficial. El artículo se torna resistente a los solventes, a los ácidos y a los diversos productos empleados en la cocina, manteniendo intactas sus características químico/físicas. Es un tratamiento absolutamente biocompatible, antialérgico y apto para el contacto con los alimentos.

Die PVD Technik ermöglicht die Beschichtung mit einem dickwandigen Metallfilm von überraschenden dekorativen und technischen Merkmalen. Das Verfahren verleiht dem Produkt längere Lebensdauer und eine ausgeprägte Oberflächenhärte, macht beständig gegen Lösungsmittel, Säuren und verschiedene Haushaltsmittel, wobei die chemischen und physischen Eigenschaften des Produkts selbst intakt bleiben. Die Behandlung ist absolut bioverträglich, allergenfrei und lebensmitteltauglich.

La tecnica PVD (Physical Vapour Deposition) permette di depositare un film metallico di alto spessore con caratteristiche sorprendenti dal punto di vista decorativo e tecnico. Questo procedimento rende il prodotto trattato durevole nel tempo e conferisce elevata durezza superficiale. L'articolo diventa resistente ai solventi, agli acidi e a vari prodotti usati in cucina, mantenendo intatte le proprie caratteristiche chimico/fisiche. E' un trattamento assolutamente biocompatibile, anallergico ed idoneo al contatto con il cibo.



PVD Oro

PVD Gold

Cod. ...41



PVD Rame

PVD Copper

Cod. ...40



PVD Nero

PVD Black

Cod. ...42



PVD Bronzo

PVD Bronze

Cod. ...85





**Polvere di Luna
PVD Oro**

Moon Dust PVD Gold

Cod. ...35



**Polvere di Luna
PVD Rame**

Moon Dust PVD Copper

Cod. ...53



**Polvere di Luna
PVD Nero**

Moon Dust PVD Black

Cod. ...39



**Polvere di Luna
PVD Bronzo**

Moon Dust PVD Bronze

Cod. ...83





Vintage PVD Oro
Vintage PVD Gold

Cod. ...57



Vintage PVD Rame
Vintage PVD Copper

Cod. ...56



Vintage PVD Nero
Vintage PVD Black

Cod. ...76



Vintage PVD Bronzo
Vintage PVD Bronze

Cod. ...84





VA
SEL
LA
ME

FINITURE SPECIALI

The range of special finishes can be applied to hollowware products as well, creating contemporary taste combinations. Matching finishes and colours you can customise your style, enhancing it with new looks and unusual effects.

La gamme de finitions spéciales peut être appliquée aux accessoires aussi, en créant combinaisons du goût contemporain. En assortant finitions et couleurs il est possible de personnaliser son propre style, en l'enrichissant par présentations nouvelles et effets inhabituels.

La gama de acabados especiales se puede aplicar en productos de vajilla también, creando mezclas de gusto contemporáneo. Combinando acabados y colores es posible personalizar su estilo, enriqueciéndolo con nuevas presentaciones y efectos insólitos.

Die Serie von Spezialoberflächen kann auch auf Geschirrprodukte angewendet werden. Auf diese Weise man kann Kombinationen mit einem zeitgemäßen Geschmack erschaffen. Durch die Kombination von Oberflächen und Farben können Sie Ihren eigenen Stil anpassen und ihn mit neuer Kleidung und ungewöhnlichen Effekten bereichern.

Vasellame - Hollowware

Finiture speciali - Special Finishes

La gamma di finiture speciali può essere applicata anche ai prodotti di vasellame, creando combinazioni dal gusto contemporaneo. Abbinando finiture e colori è possibile personalizzare il proprio stile, arricchendolo con vesti nuove ed effetti inconsueti.



PVD oro

Mirror PVD Gold
cod. ...41

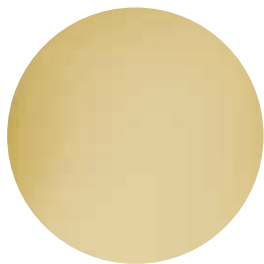

PVD rame

Mirror PVD Copper
cod. ...40



PVD nero

Mirror PVD Black
cod. ...42





**Polvere di Luna
PVD oro**

Moon dust PVD Gold
cod. ... 35



**Polvere di Luna
PVD rame**

Moon dust PVD Copper
cod. ... 53



**Polvere di Luna
PVD nero**

Moon dust PVD Black
cod. ... 39





Vintage PVD oro

Vintage PVD Gold
cod. ...57



Vintage PVD rame

Vintage PVD Copper
cod. ...56

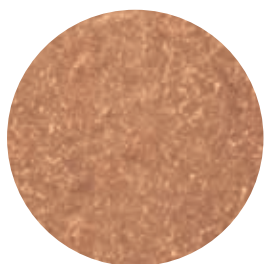

Vintage PVD nero

Vintage PVD Black
cod. ...76

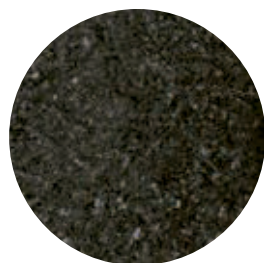



ACCESSORIES

ACCESSORIES

Bacchette sushi Ergo

Ergo sushi chopsticks
 Baguettes à sushi Ergo
 Ergo Sushi stäbchen
 Palillos para sushi Ergo

Inox 18/10 - St. Steel

| | mm | in |
|---------------------|-----|----|
| 903 05 84 660 X | 230 | 9 |
| Set 2 pz - 2-pc set | | |

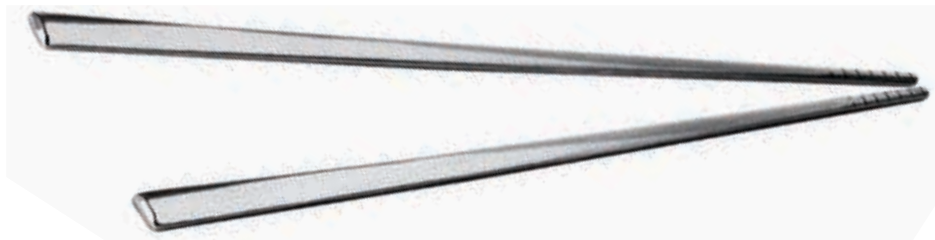

Poggiabastoncini Ergo

Ergo Cutlery stand
 Porte - couverts Ergo
 Ergo Besteck Bänke
 Posa cubiertos Ergo

Inox 18/10 - St. Steel

| | mm | in |
|---------------|----|-------|
| 903 05 84 662 | 60 | 2,3/8 |



Bacchette sushi Lapis

Lapis sushi chopsticks
 Baguettes à sushi Lapis
 Lapis Sushi stäbchen
 Palillos para sushi Lapis

Inox/Abs - St. Steel/Abs

| | mm | in |
|---------------------|-----|----|
| TLA 154 02 82 | 230 | 9 |
| Set 2 pz - 2-pc set | | |



Poggiabastoncini ABS

ABS cutlery stand
 Porte - couverts ABS
 ABS Besteck Bänke
 Posa cubiertos ABS

Abs

| | | mm | in |
|---------------|--------|----------|-------------|
| 118 12 00 081 | Trasp. | 50x28x12 | 2x1,1/8x3/8 |
| 118 12 00 082 | Nero | 50x28x12 | 2x1,1/8x3/8 |



Legatovaglioli / poggiabastoncini Bamboo

Bamboo napkin ring / cutlery stand
 Rond de serviettes / porte - couverts Bamboo
 Serviettenhalter / posa cubiertos, Bamboo
 Servilletero / besteck bänke Bamboo

Inox 18/10 - St. Steel

| | mm | H. mm | in | H In |
|---------------|-------|-------|-------------|-------|
| V01 05 81 005 | 60x35 | 40 | 2.3/8x1,3/8 | 1,1/2 |

Disegnato da Tianshu Shi e Mengdi Xu

**Poggiaposate rotondo**

Round cutlery stand
 Porte-couverts rond
 Bestek bänke rund
 Posa cubiertos redondo

Inox 18/10 - St. Steel

| | ø mm | ø in |
|---------------|------|------|
| 903 05 84 670 | 100 | 3,9 |

● **Vintage** - 903 51 84 670

● **Vintage copper** - 903 56 84 670

● **Vintage gold** - 903 57 84 670

**Legatovaglioli tondo**

Round napkin ring
 Rond de serviette
 Serviettenhalter
 Servilletero redondo

Inox 18/10 - St. Steel

| | ø mm | ø in |
|---------------|------|-------|
| V01 05 81 001 | 40 | 1,2/3 |

**Poggiabastoncini Branch**

Branch cutlery stand
 Porte - couverts Branch
 Branch Besteck Bänke
 Posa cubiertos Branch

Inox 18/10 - St. Steel

| | mm | in |
|---------------|-------|---------|
| 903 05 84 661 | 30x74 | 1,1/8x3 |



Cucchiaino cereali

Cereal spoon
Cuillère à céréales
Cerealienlöffel
Cuchara de cereales

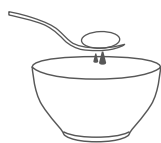

Acciaio Inox 18/10 - St. Steel 18/10

| | mm | in |
|---------------|-----|-------|
| 908 05 00 006 | 185 | 7,1/4 |



Cucchiaino tè/moka

Tea spoon
Cuillère à moka
Tee-/Mokalöffel
Cuchara de moka



Acciaio Inox 18/10 - St. Steel 18/10

| | mm | in |
|---------------|-----|-------|
| 908 05 00 003 | 120 | 4,3/4 |



Paletta miscelatore

Coffee stirrer
Agitateur à café
Kaffee-Rührer
Paleta café



Acciaio Inox 18/10 - St. Steel 18/10

| | mm | in |
|---------------|-----|----|
| 908 05 00 005 | 100 | 4 |



Cucchiaino spatolina

Spatula spoon
Cuillère spatule
Spatel - Spatenlöffel
Cuchinilla spatula



Acciaio Inox 18/10 - St. Steel 18/10

| | mm | in |
|---------------|-----|----|
| 908 05 00 002 | 149 | 6 |



Cucchiaino yogurt/cioccolato/marmellata

Yogurt / chocolate / jam spoon
Cuillère à yaourt / chocolat / confiture
Joghurt / Schokoladen / Marmeladenlöffel
Cuchara yogur / chocolate / mermelada



Acciaio Inox 18/10 - St. Steel 18/10

| | mm | in |
|---------------|-----|-------|
| 908 05 00 001 | 121 | 4,3/4 |



Cucchiaino servi miele con piega

S-shaped honey serving spoon
Cuillère à miel pliée
Gebogener Honiglöffel
Cuchara para miel plegada



Acciaio Inox 18/10 - St. Steel 18/10

| | mm | in |
|---------|-----|-------|
| C89 390 | 140 | 5,1/2 |





Appetizer Double (cucchiaino forchettina)

Double appetizer (spoon fork)
 Cuillère de mise en bouche Double (cuillère fourchette)
 Appetizerlöffel doppelt (Löffel & Gabel)
 Aperitivo Double (cuchara tenedor)

Acciaio Inox 18/10 - St. Steel 18/10

| | mm | in |
|----------|-----|-------|
| CF7 PDFS | 122 | 4,3/4 |

**Cucchiaino moka appetizer con foro Linea**

Linea moka spoon appetizer with hole
 Cuillère à moka de mise en bouche avec trou Linea
 Appetizer Mokalöffel mit Lock Linea
 Cuchara moka aperitivo con agujero Linea

Acciaio Inox 18/10 - St. Steel 18/10

| | mm | in |
|----------|-----|-------|
| CF7P 22F | 106 | 4,1/8 |

**Cucchiaino caffè' appetizer Linea**

Linea tea spoon appetizer
 Cuillère à thé de mise en bouche Linea
 Appetizer Kaffee/Teelöffel Linea
 Cuchara café aperitivo Linea

Acciaio Inox 18/10 - St. Steel 18/10

| | mm | in |
|---------|-----|-------|
| CF7P 21 | 122 | 4,3/4 |

**Forchetta 2 punte appetizer Linea**

Linea fork appetizer, two-prong
 Fourchette de mise en bouche à deux dents Linea
 Appetizer Zweizinkengabel Linea
 Tenedor aperitivo dos puntas Linea

Acciaio Inox 18/10 - St. Steel 18/10

| | mm | in |
|---------|-----|-------|
| CF7P 63 | 105 | 4,1/8 |

**Cucchiaino moka appetizer Linea**

Linea moka spoon appetizer
 Cuillère à moka de mise en bouche Linea
 Appetizer Mokalöffel Linea
 Cuchara moka aperitivo Linea

Acciaio Inox 18/10 - St. Steel 18/10

| | mm | in |
|---------|-----|-------|
| CF7P 22 | 106 | 4,1/8 |

**Cucchiaino bibita appetizer Linea**

Linea cocktail spoon
 Cuillère à mazagran Linea
 Cocktaillöffel Linea
 Cuchara refresco Linea

Acciaio Inox 18/10 - St. Steel 18/10

| | mm | in |
|---------|-----|-------|
| CF7P 35 | 210 | 8,1/4 |



Cucchiaino caffè Svezia

Svezia coffee spoon
 Cuillère à café Svezia
 Kaffee/Teelöffel Svezia
 Cuchara café Svezia

Acciaio Inox - St. Steel

| | mm | in |
|--------|-----|-------|
| CSV 21 | 140 | 5,1/2 |

**Cucchiaino bibita Svezia**

Svezia cocktail spoon
 Cuillère à cocktail Svezia
 Cocktaillöffel Svezia
 Cuchara refresco Svezia

Acciaio Inox - St. Steel

| | mm | in |
|--------|-----|----|
| CSV 35 | 204 | 8 |

**Cucchiaino moka Svezia**

Svezia moka spoon
 Cuillère à moka Svezia
 Mokalöffel Svezia
 Cuchara moka Svezia

Acciaio Inox - St. Steel

| | mm | in |
|--------|-----|-------|
| CSV 22 | 105 | 4,1/8 |

**Cucchiaino gelato Svezia**

Svezia ice cream spoon
 Cuillère à glace Svezia
 Eislöffel Svezia
 Cuchara helado Svezia

Acciaio Inox - St. Steel

| | mm | in |
|--------|-----|-------|
| CSV 37 | 131 | 5,1/8 |

**Forchetta dolce Svezia**

Svezia cake fork
 Fourchette à gâteau Svezia
 Kuchengabel Svezia
 Tenedor lunch Svezia

Acciaio Inox - St. Steel

| | mm | in |
|--------|-----|-------|
| CSV 38 | 145 | 5,3/4 |



Cucchiaino moka Riflesso

Riflesso moka spoon
 Cuillère à moka Riflesso
 Mokalöffel Riflesso
 Cuchara moka Riflesso

Acciaio Inox 18/10 - St. Steel 18/10

| | mm | in |
|----------------|------------|--------------|
| C33P 22 | 108 | 4,3/8 |



Cucchiaino caffè Riflesso

Riflesso coffee spoon
 Cuillère à café Riflesso
 Kaffee/Teelöffel Riflesso
 Cuchara café Riflesso

Acciaio Inox 18/10 - St. Steel 18/10

| | mm | in |
|----------------|------------|--------------|
| C33P 21 | 130 | 5,7/8 |



Paletta gelato Riflesso

Riflesso ice cream spoon
 Cuillère à glace Riflesso
 Eislöffel Riflesso
 Cuchara helado Riflesso

Acciaio Inox 18/10 - St. Steel 18/10

| | mm | in |
|----------------|------------|--------------|
| C33P 37 | 130 | 5,1/8 |



Cucchiaino bibita Riflesso

Riflesso cocktail spoon
 Cuillère à cocktail Riflesso
 Cocktaillöffel Riflesso
 Cuchara refresco Riflesso

Acciaio Inox 18/10 - St. Steel 18/10

| | mm | in |
|----------------|------------|--------------|
| C33P 35 | 201 | 7,7/8 |



Cucchiaino caffè con piega Riflesso

Riflesso s-shaped tea spoon
 Cuillère à thé pliée
 Riflesso - Gebogener Teelöffel Riflesso
 Cucharita café plegada Riflesso

Acciaio Inox 18/10 - St. Steel 18/10

| | mm | in |
|-----------------|------------|--------------|
| C33P 392 | 115 | 4,1/2 |



Cucchiaino bibita con piega Riflesso

Riflesso s-shaped cocktail spoon
 Cuillère à mazagran pliée Riflesso
 Gebogener Cocktaillöffel Riflesso
 Cuchara refresco plegada Riflesso

Acciaio Inox 18/10 - St. Steel 18/10

| | mm | in |
|-----------------|------------|--------------|
| C33P 394 | 185 | 7,1/4 |



Forchettina dolce Riflesso

Riflesso cake fork
 Fourchette à gâteau Riflesso
 Kuchengabel Riflesso
 Tenedor lunch Riflesso

Acciaio Inox 18/10 - St. Steel 18/10

| | mm | in |
|---------|-----|-------|
| C33P 38 | 144 | 5,3/4 |

**Forchettina 2 punte Riflesso**

Riflesso two-prong fork
 Fourchette à deux dents Riflesso
 Zweizinkengabel Riflesso
 Tenedor dos puntas Riflesso

Acciaio Inox 18/10 - St. Steel 18/10

| | mm | in |
|---------|-----|-------|
| C33P 63 | 144 | 5,3/4 |

**Cucchiaino fragola e confetti Milord**

Milord sweet spoon
 Cuillère à sucreries Milord
 Erdbeer- und Konfektlöffel Milord
 Cuchara para dulces Milord

Acciaio Inox 18/10 - St. Steel 18/10

| | mm | in |
|--------|-----|-------|
| C14 36 | 170 | 6,5/8 |

**Cucchiaino fragola e confetti Imperial**

Imperial sweet spoon
 Cuillère à sucreries Imperial
 Erdbeer- und Konfektlöffel Imperial
 Cuchara para dulces Imperial

Acciaio Inox 18/10 - St. Steel 18/10

| | mm | in |
|--------|-----|-------|
| C04 36 | 170 | 6,5/8 |

**Cucchiaino olive con fori**

Olive slotted spoon
 Cuillère de mise en bouche olives perforée
 Gelochter Oliven Löffel
 Cuchara aceitunas perforada

Acciaio Inox 18/10 - St. Steel 18/10

| | mm | in |
|---------------|-----|-------|
| 903 05 81 AOF | 225 | 8,7/8 |

**Cucchiaino olive**

Olive spoon
 Cuillère de mise en bouche olives
 Oliven Löffel
 Cuchara aceitunas

Acciaio Inox 18/10 - St. Steel 18/10

| | mm | in |
|---------------|-----|-------|
| 903 05 81 AOL | 225 | 8,7/8 |



Cucchiaino moka 903

903 Moka spoon
Cuillère à moka 903
Mokalöffel 903
Cuchara moka 903

Acciaio Inox - St. Steel

| | mm | in |
|---------------|-----|-------|
| 903 06 81 024 | 111 | 4,3/8 |



Cucchiaino ghiaccio Matisse piccolo

Matisse slotted ice spoon
Cuillère à glaçons perforée Matisse
Kleiner Eiswürfelloffel Matisse
Cuchara hielo perforada Matisse

Acciaio Inox 18/10 - St. Steel 18/10

| | mm | in |
|---------|-----|-------|
| CF1 251 | 170 | 6,5/8 |



Cucchiaino multiuso Matisse grande

Matisse slotted spoon large
Cuillère à servir perforée Matisse grande
Großer Universallöffel Matisse
Cuchara para servir perforada Matisse grande

Acciaio Inox 18/10 - St. Steel 18/10

| | mm | in |
|---------|-----|-------|
| CF1 162 | 205 | 8,1/8 |



Mestolino unipezzo yogurt/salsa

Yogurt/sauce ladle, small
Louche à sauce en une pièce
Schopflöffel klein einteilig
Cacillo salsa de una sola pieza

Acciaio Inox 18/10 - St. Steel 18/10

| | mm | in |
|----------|-----|-------|
| CI108446 | 174 | 6,7/8 |



Forchettina appetizer segnaposto

Place-card appetizer fork

Fourchette de mise en bouche marque-place

Tischkarte Appetizer Gabel

Tenedor aperitivo etiqueta

Acciaio Inox 18/10 - St. Steel 18/10

| | H. mm | H. in |
|---------------|-------|-------|
| 903 05 81 APF | 97 | 3,7/8 |

Double

Double

Double

Doppel

Double

Acciaio Inox 18/10 - St. Steel 18/10

| | mm | in |
|---------------|-----|-------|
| 903 05 81 DFS | 165 | 6,1/2 |

Appetizer Matisse con riccio

Matisse curled appetizer

Cuillère de mise en bouche en boucle

Appetizerlöffel

Aperitivo con nudo - cuchara

Acciaio Inox 18/10 - St. Steel 18/10

| | | mm | in |
|--------|-------|-----|-------|
| CF1 CR | SPOON | 141 | 5,1/2 |
| CF1 FR | FORK | 136 | 5,3/8 |

Appetizer Brigitte con piega

Bended appetizer spoon Brigitte

Mise en bouche pliée Brigitte

Appetizerlöffel Brigitte

Aperitivo plegada Brigitte

Acciaio Inox 18/10 - St. Steel 18/10

| | | mm | in |
|--------|-------|-----|-------|
| C68 CP | SPOON | 142 | 5,1/2 |
| C68 FP | FORK | 142 | 5,1/2 |



Tapas Matisse

Matisse Tapas
Cuillère Tapas Matisse
Tapas Matisse
Tapas Matisse

Acciaio Inox 18/10 - St. Steel 18/10

| | mm | in |
|--------|-----|-------|
| CF1 TA | 170 | 6,3/4 |



Cucchiaio appetizer tondo

Appetizer curved spoon
Cuillère de mise en bouche ronde pliée
Appetizer - rund gebogener Löffel
Cuchara aperitivo redonda plegada

Acciaio Inox 18/10 - St. Steel 18/10

| | mm | in |
|---------------|-----|-------|
| 903 05 81 APC | 140 | 5,1/2 |



Mini appetizer Ego

Ego mini appetizer
Mini mise en bouche Ego
Mini Appetizer Ego
Mini aperitivo Ego

Acciaio Inox 18/10 - St. Steel 18/10

| | mm | in | |
|---------|-----|-------|-------|
| CD3 22 | 115 | 4,1/2 | SPOON |
| CD3 38M | 115 | 4,1/2 | FORK |



Mini appetizer Niagara

Niagara mini appetizer
Mini mise en bouche Niagara
Mini Appetizer Niagara
Mini aperitivo Niagara

Acciaio Inox 18/10 - St. Steel 18/10

| | mm | in | |
|--------|-----|-------|-------|
| CZ322 | 113 | 4,1/2 | SPOON |
| CZ338M | 115 | 4,1/2 | FORK |





Coltello carne Modern seghettato

Modern steak knife, serrated-edge
 Couteau à bifteck Modern à lame dentelée
 Modern Steakmesser
 Cuchillo carne Modern filo dentado



Acciaio Inox - St. Steel / ABS

| | mm | in |
|-------------|-----|----|
| 903 06 86 A | 227 | 9 |

Coltello carne Modern filo rasoio

Modern steak knife, plain-edge
 Couteau à bifteck Modern à lame rasoir
 Modern Steakmesser
 Cuchillo carne Modern filo liso



Acciaio Inox - St. Steel / ABS

| | mm | in |
|-------------|-----|----|
| 903 06 86 B | 227 | 9 |

Coltello Angus seghettato

Angus steak knife, serrated-edge
 Couteau à bifteck Angus à lame dentelée
 Angus Steakmesser
 Cuchillo carne Angus filo dentado



Acciaio Inox - St. Steel / POM

| | mm | in |
|--------|-----|----|
| CAN 55 | 229 | 9 |

Coltello Angus filo rasoio

Angus steak knife, plain-edge
 Couteau à bifteck Angus à lame rasoir
 Angus Steakmesser
 Cuchillo carne Angus filo liso



Acciaio Inox - St. Steel / POM

| | mm | in |
|---------|-----|----|
| CAN 55R | 229 | 9 |

**Coltello carne Safari
seghettato - serrated blade**

Safari steak knife
Couteau à bifteck Safari à lame dentelée
Safari Steakmesser
Cuchillo carne Safari filo dentado

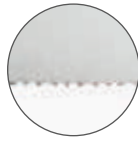

Acciaio Inox - St. Steel
Legno - Wood

| | mm | in |
|------------|-----|-------|
| CE5 A5 5LC | 235 | 9,1/4 |

**Coltello carne Texas
filo rasoio - razor-edge**

Texas steak knife
Couteau à bifteck Texas à lame rasoir
Texas Steakmesser
Cuchillo carne Texas filo liso



Acciaio Inox - St. Steel
Legno - Wood

| | mm | in |
|------------|-----|-------|
| CAN 55 LCR | 235 | 9,1/4 |

**Coltello carne Memphis
seghettato - serrated blade**

Memphis steak knife
Couteau à bifteck Memphis
Memphis Steakmesser
Cuchillo carne Memphis

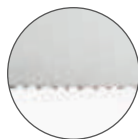

Acciaio Inox - St. Steel
Legno - Wood

| | mm | in |
|-----------|-----|-------|
| CKO 55 LC | 250 | 9.7/8 |

Coltello carne Kobe

Kobe steak knife
 Couteau à bifteck Kobe
 Kobe Steakmesser
 Cuchillo carne Kobe

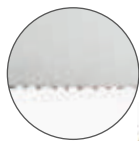

Acciaio Inox - St. Steel

Legno - Wood

| | mm | in |
|--------|-----|-------|
| CKO 55 | 244 | 9,5/8 |

Coltello carne Kobe

Kobe steak knife
 Couteau à bifteck Kobe
 Kobe Steakmesser
 Cuchillo carne Kobe



Acciaio Inox - St. Steel

Legno - Wood

| | mm | in |
|---------|-----|-------|
| CKO 55R | 244 | 9,5/8 |

Coltello carne Fuego

Fuego steak knife
 Couteau à bifteck Fuego
 Fuego Steakmesser
 Cuchillo carne Fuego

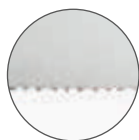

Acciaio Inox - St. Steel / ABS

| | mm | in |
|--------|-----|----|
| CFU 55 | 232 | 9 |

Coltello carne Fuego

Fuego steak knife
 Couteau à bifteck Fuego
 Fuego Steakmesser
 Cuchillo carne Fuego



Acciaio Inox - St. Steel / ABS

| | mm | in |
|---------|-----|----|
| CFU 55R | 232 | 9 |

Coltello carne Kansas

Kansas steak knife
 Couteau à bifteck Kansas
 Kansas Steakmesser
 Cuchillo carne Kansas



Acciaio Inox - St. Steel / POM

| | mm | in |
|--------|-----|-------|
| CKA 55 | 218 | 8,5/8 |

Blister coltelli carne Rost punta

Rost steak knives blister
 Blister de couteaux à viande Rost
 Fleischmesser Rost Blisterpackung
 Blister cuchillos carne Rost

| | | mm | in |
|---------------|--------|-----|-------|
| AVARI 064B 06 | pcs 6 | 210 | 8,1/4 |
| AVARI 064B 12 | pcs 12 | 210 | 8,1/4 |



Blister coltelli carne Rost punta tonda

Blister of Rost steak knives, rounded tip
 Blister de couteaux à viande Rost pointe ronde
 Fleischmesser Rost Blisterpackung
 Blister cuchillos carne Rost punta redonda

| | | mm | in |
|----------------|--------|-----|-------|
| AVARI 064T B06 | pcs 6 | 212 | 8,1/4 |
| AVARI 064T B12 | pcs 12 | 212 | 8,1/4 |



Blister coltelli pizza Rost

Pizza knives Rost blister
 Blister de couteaux à pizza Rost
 Rost Pizzamesser Blisterpackung
 Blister cuchillos pizza Rost

| | | mm | in |
|----------------|--------|-----|-------|
| AVARI 064P B06 | pcs 6 | 200 | 7,7/8 |
| AVARI 064P B12 | pcs 12 | 200 | 7,7/8 |



Coltello fiorentina

Fiorentina steak knife
 Couteau à bifteck Fiorentina
 Fiorentina Steakmesser
 Cuchillo carne Fiorentina

Acciaio Inox - St. Steel

| | mm | in |
|--------|-----|----|
| CFI 55 | 230 | 9 |



Forchetta fiorentina

Fiorentina steak fork
 Fourchette à bifteck Fiorentina
 Fiorentina Steakgabel
 Tenedor carne Fiorentina

Acciaio Inox 18/10 - St. Steel 18/10

| | mm | in |
|--------|-----|----|
| CFI 02 | 204 | 8 |



Coltello carne Malaga

Malaga steak knife
 Couteau à bifteck Malaga
 Malaga Fleischmesser
 Cuchillo carne Malaga

Acciaio Inox - St. Steel

| | mm | in |
|--------|-----|-------|
| CMA 55 | 231 | 8,5/8 |



Forchetta carne Altozano/Malaga

Altozano steak fork
 Fourchette à bifteck Altozano
 Altozano Steakgabel
 Tenedor carne Altozano

Acciaio Inox 18/10 - St. Steel 18/10

| | mm | in |
|--------|-----|----|
| CAL 52 | 205 | 8 |



Coltello carne Pampero / C

Pampero steak knife
 Couteau à bifteck Pampero
 Pampero Steakmesser
 Cuchillo carne Pampero

Acciaio Inox - St. Steel

| | mm | in |
|----------|-----|-------|
| CPP 55 C | 222 | 8,5/8 |



Pampa forchetta carne

Pampa steak fork
 Fourchette à bifteck
 Carne/Bistecca Tenedor chuletero
 Pampa Pampa Steakgabel

Acciaio inox - St-Steel

| | mm | in |
|--------|-----|-------|
| CPA52C | 197 | 7,7/8 |



Coltello pizza carne Azzurra

Azzurra pizza knife
 Couteau à pizza Azzurra
 Azzurra Pizzamesser
 Cuchillo pizza Azzurra

Acciaio Inox - St. Steel

| | mm | in |
|---------|-----|-------|
| CZ 7134 | 225 | 8,7/8 |



Forchetta pizza Azzurra

Azzurra pizza fork
 Fourchette à pizza Azzurra
 Azzurra Pizzagabel
 Tenedor pizza Azzurra

Acciaio Inox - St. Steel

| | mm | in |
|--------|-----|-------|
| CZ 752 | 200 | 7,7/8 |



Coltello pizza Modern acciaio

Modern pizza knife
 Couteau à pizza Modern
 Modern Pizzamesser
 Cuchillo pizza Modern

Acciaio Inox - St. Steel

| | mm | in |
|---------|-----|----|
| CPI 05P | 205 | 8 |



Forchetta pizza Modern acciaio

Modern pizza fork
 Fourchette à pizza Modern
 Modern Pizzagabel
 Tenedor pizza Modern

Acciaio Inox - St. Steel

| | mm | in |
|-----------|-----|-------|
| CPI 02 CR | 203 | 7,7/8 |



Coltello carne Modern acciaio

Modern steak knife
 Couteau à bifteck Modern
 Modern Steakmesser
 Cuchillo carne Modern

Acciaio Inox - St. Steel

| | mm | in |
|--------|-----|-------|
| CPI 05 | 226 | 8,7/8 |



Coltello pizza Palio

Pizza knife Palio
 Couteau à pizza Palio
 Palio Pizzamesser
 Cuchillo pizza Palio

Acciaio Inox - St. Steel

| | mm | in |
|---------|-----|-------|
| CC3 134 | 210 | 8,1/4 |



Forchetta carne Ergo

Ergo steak fork
 Fourchette à bifteck Ergo
 Ergo Steakgabel
 Tenedor carne Ergo

Acciaio inox 18/10 - St-Steel 18/10

| | mm | in |
|-------|-----|-------|
| CE552 | 210 | 8,1/4 |



Coltello carne Pampero

Pampero steak knife
 Couteau à bifteck Pampero
 Pampero Steakmesser
 Cuchillo carne Pampero

Acciaio Inox - St. Steel

| | mm | in |
|--------|-----|-------|
| CPP 55 | 222 | 8,5/8 |



Coltello carne Flair

Flair steak knife
 Couteau à bifteck FLair
 Flair Steakmesser
 Cuchillo carne Flair

Acciaio Inox - St. Steel

| | mm | in |
|-------|-----|-------|
| C0255 | 220 | 8,5/8 |



Coltello carne Milord

Milord steak knife
 Couteau à bifteck Milord
 Milord Steakmesser
 Cuchillo carne Milord

Acciaio Inox - St. Steel

| | mm | in |
|-------|-----|----|
| C1455 | 233 | 9 |



Coltello carne Victory

Victory steak knife
 Couteau à bifteck Victory
 Victory Steakmesser
 Cuchillo carne Victory

Acciaio Inox - St. Steel

| | mm | in |
|-------|-----|----|
| CP255 | 230 | 9 |



Pinza aragosta forgiata

Lobster cracker, forged
 Pince à homard forgé
 Langustezange - geschmieden
 Pinzas langosta forjadas

Acciaio Inox - St. Steel

| | mm | in |
|---------------|-----|-------|
| 305 05 91 658 | 190 | 7,1/2 |

**Stiletto aragosta**

Lobster pick
 Fourchette à homard
 Langustegabel
 Tenedor langosta

Acciaio Inox 18/10 - St. Steel 18/10

| | mm | in |
|---------------|-----|-------|
| 903 05 84 659 | 202 | 7,7/8 |

**Forchettina ostriche**

Oyster fork
 Fourchette à crustacés
 Austerngabel
 Tenedor ostras

Acciaio Inox 18/10 - St. Steel 18/10

| | mm | in |
|--------|-----|-------|
| CF1 64 | 156 | 6,1/8 |

**Stiletto ostriche/crostacei**

Oyster fork
 Fourchette à crustacés
 Krustengabel
 Tenedor mariscos

Acciaio Inox 18/10 - St. Steel 18/10

| | mm | in |
|--------|-----|-------|
| CPA 64 | 227 | 8,7/8 |

**Forchettina 2 punte Matisse**

Matisse fork, two-prong
 Fourchette à deux dents Matisse
 Zweizinkengabel Matisse
 Tenedor dos puntas Matisse

Acciaio Inox 18/10 - St. Steel 18/10

| | mm | in |
|--------|-----|-------|
| CF1 63 | 156 | 3,1/8 |

**Molla lumache**

Snail tongs
 Pince à escargots
 Schneckenzange
 Pinzas caracoles

Acciaio Inox - St. Steel

| | mm | in |
|---------------|-----|-------|
| 903 05 81 MLU | 160 | 6,1/4 |



Coltello formaggi cremosi Regis Spalmy

Spalmy creamy cheese knife
 Couteau à fromages crèmeux Spalmy
 Schmelzkäsemesser Spalmy
 Cuchillo quesos cremosos Spalmy

Acciaio Inox - St. Steel

| | mm | in |
|------------|-----|-------|
| 903 05 84D | 225 | 8,7/8 |

**Coltello paste molli Regis Tommy**

Tommy tender cheese knife
 Couteau à fromages à pâte molle Tommy
 Weichkäsemesser Tommy
 Cuchillo quesos pasta blanda Tommy

Acciaio Inox - St. Steel

| | mm | in |
|------------|-----|-------|
| 903 05 84A | 218 | 8,5/8 |

**Coltello 2 punte Regis Emmy**

Emmy medium-hard cheese knife
 Couteau à fromages à pâte demi-ferme Emmy
 Milderkäsemesser Emmy
 Cuchillo quesos pasta semi-dura Emmy

Acciaio Inox - St. Steel

| | mm | in |
|------------|-----|-------|
| 903 05 84B | 221 | 8,5/8 |

**Coltello formaggi di paste crude Regis Parmy**

Parmy hard cheese knife
 Couteau à fromages à pâte ferme Parmy
 Hartkäsemesser Parmy
 Cuchillo quesos pasta dura Parmy

Acciaio Inox - St. Steel

| | mm | in |
|------------|-----|-------|
| 903 05 84C | 199 | 7,7/8 |

**Coltello formaggelle Regis Formy**

Formy formaggelle soft cheese knife
 Couteau à fromages à pâte molle formaggelle Formy
 Frischkäsemesser Formy
 Cuchillo quesos pasta blanda formaggelle Formy

Acciaio Inox - St. Steel

| | mm | in |
|------------|-----|--------|
| 903 05 84E | 273 | 10,5/8 |

**Affettaformaggio Regis**

Regis cheese slicer
 Pelle coupe-fromage Regis
 Käsehobel Regis
 Pala corta queso Regis

Acciaio Inox - St. Steel

| | mm | in |
|---------------|-----|-------|
| 903 05 84 135 | 190 | 7,1/2 |





Forchettone arrosto manico vuoto Lux

Roast serving fork hollow handle
 Grande fourchette rôti, manche creuse
 Fleischgabel, hohem Heft
 Tenedor asado, mango hueco

Acciaio Inox - St. Steel

| | mm | in |
|---------------|-----|--------|
| 903 05 91 MS1 | 275 | 11,1/4 |



Coltello arrosto manico vuoto Lux

Roast serving knife hollow handle
 Couteau à bifteck, manche creuse
 Filetmesser, hohem Heft
 Cuchillo carne, mango hueco

Acciaio Inox - St. Steel

| | mm | in |
|---------------|-----|--------|
| 903 05 91 MS1 | 315 | 12,3/8 |



Coltello pane/panettone Lux

Panettone knife hollow handle
 Couteau à tarte lame denteleé, manche creuse
 Kuchenmesser, hohem Heft
 Cuchillo pastel dentado, mango hueco

Acciaio Inox - St. Steel

| | mm | in |
|---------------|-----|--------|
| 903 05 91 MV1 | 285 | 11,1/4 |



Cucchiaine buffet Milord cm. 34

Milord buffet serving spoon, cm. 34
 Cuillère de service buffet Milord cm. 34
 Milord Buffetlöffel, cm. 34
 Cuchara para servir buffet Milord cm. 34

Acciaio Inox 18/10 - St. Steel 18/10

| | mm | in |
|---------|-----|-------|
| C142710 | 340 | 13,38 |

Cucchiaine servire Milord

Milord serving spoon
 Cuillère de service Milord
 Milord Servierlöffel
 Cuchara para servir Milord

Acciaio Inox 18/10 - St. Steel 18/10

| | mm | in |
|-------|-----|----|
| C1427 | 227 | 9 |

Cucchiaine forato Milord

Milord serving spoon w/holes
 Cuillère de service perforée Milord
 Milord Servierlöffel, gelocht
 Cuchara para servir c/agujeros Milord

Acciaio Inox 18/10 - St. Steel 18/10

| | mm | in |
|-------|-----|----|
| C1460 | 227 | 9 |

Cucchiaine buffet forato Milord cm. 34

Milord buffet serving spoon w/holes, cm. 34
 Cuillère de service buffet perforée Milord cm. 34
 Milord Buffetlöffel, gelocht, cm. 34
 Cucharón para servir buffet c/agujeros Milord cm. 34

Acciaio Inox 18/10 - St. Steel 18/10

| | mm | in |
|---------|-----|-------|
| C142720 | 340 | 13,38 |

Forchettone servire Milord

Milord serving fork
 Fourchette de service Milord
 Milord Serviergabel
 Tenedor para servir Milord

Acciaio Inox 18/10 - St. Steel 18/10

| | mm | in |
|-------|-----|----|
| C1426 | 228 | 9 |

Cucchiaine insalata Milord

Milord salad serving spoon
 Cuillère a servir salade Milord
 Milord Servierlöffel Salad
 Cuchara para servir ensalada Milord

Acciaio Inox 18/10 - St. Steel 18/10

| | mm | in |
|-------|-----|----|
| C1428 | 227 | 9 |

Forchetta insalata Milord

Milord salad serving fork
 Fourchette a servir salade Milord
 Milord Serviergabel Salad
 Tenedor para servir ensalada Milord

Acciaio Inox 18/10 - St. Steel 18/10

| | mm | in |
|-------|-----|----|
| C1429 | 227 | 9 |



C142710

C142720



C1427

C1426

C1460

C1428

C1429

Mestolino punch Milord

Milord punch ladle
Louche à punch Milord
Milord Punchkelle
Cazo punch Milord

Acciaio Inox 18/10 - St. Steel 18/10

| | mm | in |
|---------|-----|--------|
| C142520 | 285 | 11,1/4 |

Mestolino salsa Milord

Milord sauce ladle
Louche à sauce Milord
Milord Soßenkelle
Cacillo salsa Milord

Acciaio Inox 18/10 - St. Steel 18/10

| | mm | in |
|-------|-----|-------|
| C1442 | 153 | 5,7/8 |

Pala torta Milord

Milord cake server
Pelle à gâteaux Milord
Milord Tortenheber
Pala pastel Milord

Acciaio Inox 18/10 - St. Steel 18/10

| | mm | in |
|-------|-----|-------|
| C1439 | 240 | 9,1/2 |

Mestolo servire Milord cm. 30

Milord soup ladle, cm. 30
Louche Milord cm. 30
Milord Schöpflöffel, cm. 30
Cazo sopa Milord cm. 30

Acciaio Inox 18/10 - St. Steel 18/10

| | mm | in |
|-------|-----|----|
| C1425 | 304 | 12 |

Mestolo Milord cm. 20

Milord ladle, cm. 20
Louche Milord cm. 20
Milord Schöpflöffel, cm. 20
Cazo Milord cm. 20

Acciaio Inox 18/10 - St. Steel 18/10

| | mm | in |
|---------|-----|-------|
| C142510 | 198 | 7,7/8 |

Cucchiaione riso Milord

Milord rice serving spoon
Cuillère de service à riz Milord
Milord Servierlöffel Reis
Cuchara para servir arroz Milord

Acciaio Inox 18/10 - St. Steel 18/10

| | mm | in |
|-------|-----|-------|
| C1430 | 251 | 9,7/8 |



C142520

C1425

C1442



C142510

C1439

C1430

Cucchiaine buffet Marea cm. 34

Marea buffet serving spoon, cm. 34
 Cuillère de service buffet Marea cm. 34
 Marea Buffetlöffel, cm. 34
 Cuchara para servir buffet Marea cm. 34

Acciaio Inox 18/10 - St. Steel 18/10

| | mm | in |
|---------|-----|--------|
| CE42710 | 346 | 13,5/8 |

Cucchiaine servire Marea

Marea serving spoon
 Cuillère de service Marea
 Marea Servierlöffel
 Cuchara para servir Marea

Acciaio Inox 18/10 - St. Steel 18/10

| | mm | in |
|-------|-----|----|
| CE427 | 228 | 9 |

Cucchiaine forato Marea

Marea serving spoon w/holes
 Cuillère de service perforée Marea
 Marea Servierlöffel, gelocht
 Cuchara para servir c/agujeros Marea

Acciaio Inox 18/10 - St. Steel 18/10

| | mm | in |
|-------|-----|----|
| CE460 | 228 | 9 |

Cucchiaine buffet forato Marea cm. 34

Marea buffet serving spoon w/holes, cm. 34
 Cuillère de service buffet perforée Marea cm. 34
 Marea Buffetlöffel, gelocht, cm. 34
 Cucharón para servir buffet c/agujeros Marea cm. 34

Acciaio Inox 18/10 - St. Steel 18/10

| | mm | in |
|---------|-----|--------|
| CE42720 | 346 | 13,5/8 |

Forchettone servire Marea

Marea serving fork
 Fourchette de service Marea
 Marea Serviergabel
 Tenedor para servir Marea

Acciaio Inox 18/10 - St. Steel 18/10

| | mm | in |
|-------|-----|-------|
| CE426 | 237 | 9,1/4 |

Cucchiaine insalata Marea

Marea salad serving spoon
 Cuillère a servir salade Marea
 Marea Servierlöffel Salad
 Cuchara para servir ensalada Marea

Acciaio Inox 18/10 - St. Steel 18/10

| | mm | in |
|-------|-----|----|
| CE428 | 228 | 9 |

Forchetta insalata Marea

Marea salad serving fork
 Fourchette a servir salade Marea
 Marea Serviergabel Salad
 Tenedor para servir ensalada Marea

Acciaio Inox 18/10 - St. Steel 18/10

| | mm | in |
|-------|-----|----|
| CE429 | 229 | 9 |



CE42710

CE42720



CE427

CE426

CE460

CE428

CE429

Mestolino punch Marea

Marea punch ladle
 Louche à punch Marea
 Marea Punchkelle
 Cazo punch Marea

Acciaio Inox 18/10 - St. Steel 18/10

| | mm | in |
|---------|-----|----|
| CE42520 | 283 | 11 |

Mestolino salsa Marea

Marea sauce ladle
 Louche à sauce Marea
 Marea Soßenkelle
 Cacillo salsa Marea

Acciaio Inox 18/10 - St. Steel 18/10

| | mm | in |
|-------|-----|-------|
| CE442 | 152 | 5,7/8 |

Pala torta Marea

Marea cake server
 Pelle à gâteaux Marea
 Marea Tortenheber
 Pala pastel Marea

Acciaio Inox 18/10 - St. Steel 18/10

| | mm | in |
|-------|-----|-------|
| CE439 | 250 | 9,7/8 |

Mestolo servire Marea cm. 30

Marea soup ladle, cm. 30
 Louche Marea cm. 30
 Marea Schöpflöffel, cm. 30
 Cazo sopa Marea cm. 30

Acciaio Inox 18/10 - St. Steel 18/10

| | mm | in |
|-------|-----|----|
| CE425 | 305 | 12 |

Mestolo Marea cm. 20

Marea ladle, cm. 20
 Louche Marea cm. 20
 Marea Schöpflöffel, cm. 20
 Cazo Marea cm. 20

Acciaio Inox 18/10 - St. Steel 18/10

| | mm | in |
|---------|-----|-------|
| CE42510 | 202 | 7,7/8 |

Cucchiaione riso Marea

Marea rice serving spoon
 Cuillère de service à riz Marea
 Marea Servierlöffel Reis
 Cuchara para servir arroz Marea

Acciaio Inox 18/10 - St. Steel 18/10

| | mm | in |
|-------|-----|--------|
| CE430 | 264 | 10,3/8 |



CE42520

CE425

CE442

CE42510

CE439

CE430

Cucchiaine riso professionale

Professional rice-serving spoon
Cuillère à riz professionnelle
Reislöffel
Cucharón arroz profesional

Acciaio Inox 18/10 - St. Steel 18/10

| | mm | in | spessore / thickness |
|---------------|-----|----|----------------------|
| 903 05 91 795 | 256 | 10 | 2,5 mm |



Pala fritto professionale

Professional frying palette
Pelle à friture professionnelle
Schaufel
Pala frito profesional

Acciaio Inox 18/10 - St. Steel 18/10

| | mm | in | spessore / thickness |
|---------------|-----|--------|----------------------|
| 903 05 91 062 | 295 | 11,5/8 | 2.5 mm |



Cucchiaine forata professionale

Professional slotted serving spoon
Cuillère perforée professionnelle
Gelochter Löffel
Cucharón servir perforado profesional

Acciaio Inox 18/10 - St. Steel 18/10

| | mm | in | spessore / thickness |
|---------------|-----|--------|----------------------|
| 903 05 91 796 | 290 | 11,1/2 | 2,5 mm |



Cucchiaine ghiaccio professionale

Professional ice-serving spoon
Cuillère à glaçons professionnelle
Eislöffel
Cucharón hielo profesional

Acciaio Inox 18/10 - St. Steel 18/10

| | mm | in | spessore / thickness |
|---------------|-----|--------|----------------------|
| 903 05 91 063 | 290 | 11,1/2 | 2.5 mm |



Cucchiaine insalata professionale

Professional salad-serving spoon
Cuillère à salade professionnelle
Salatlöffel
Cucharón ensalada profesional

Acciaio Inox 18/10 - St. Steel 18/10

| | mm | in | spessore / thickness |
|---------------|-----|--------|----------------------|
| 903 05 91 066 | 285 | 11,1/4 | 2,5 mm |



Cucchiaine servire professionale

Professional serving spoon
Cuillère à servir professionnelle
Löffel
Cucharón servir profesional

Acciaio Inox 18/10 - St. Steel 18/10

| | mm | in | spessore / thickness |
|---------------|-----|--------|----------------------|
| 903 05 91 793 | 290 | 11,1/2 | 2.5 mm |



Cucchiaino riso forato professionale

Professional rice-serving spoon
Cuillère à riz professionnelle
Reislöffel
Cucharón arroz profesional

Acciaio Inox 18/10 - St. Steel 18/10

| | mm | in | spessore / thickness |
|-----------------|-----|----|----------------------|
| 903 05 91 795 F | 256 | 10 | 2,5 mm |



Mestolo professionale

Professional ladle
Louche professionnelle
Professionelle Schöpfkelle
Cazo profesional

Acciaio Inox 18/10 - St. Steel 18/10

| | mm | in | spessore / thickness |
|---------------|-----|--------|----------------------|
| 903 05 91 025 | 288 | 11,3/4 | 2.5 mm |



Forchettone servire professionale

Professional serving fork
Fourchette à servir professionnelle
Gabel
Tenedor servir profesional

Acciaio Inox 18/10 - St. Steel 18/10

| | mm | in | spessore / thickness |
|---------------|-----|--------|----------------------|
| 903 05 91 794 | 294 | 11,5/8 | 2.5 mm |



Forchettone arrosto professionale

Professional carving fork
Grande fourchette rôti professionnelle
Fleischgabel
Tenedor asado profesional

Acciaio Inox 18/10 - St. Steel 18/10

| | mm | in | spessore / thickness |
|---------------|-----|--------|----------------------|
| 903 05 91 064 | 285 | 11,1/4 | 2.5 mm |



Pala gratin professionale

Professional gratin server
Pelle à gratin professionnelle
Backschaufel
Pala lasaña profesional

Acciaio Inox 18/10 - St. Steel 18/10

| | mm | in | spessore / thickness |
|------------------------------|-----|--------|----------------------|
| 903 05 91 787 | 268 | 10,5/8 | 2.5 mm |
| seghettata / serrated | | | |
| 903 05 91 797 | 268 | 10,5/8 | 2.5 mm |



Coltello torta professionale

Professional cake knife
Couteau à gâteau professionnel
Tortenmesser
Cuchillo pastel profesional

Acciaio Inox 18/10 - St. Steel 18/10

| | mm | in | spessore / thickness |
|---------------|-----|--------|----------------------|
| 903 05 91 798 | 297 | 11,3/4 | 2.5 mm |



Coltello torta seghettato professionale

Professional serrated-edge cake knife
 Couteau à gâteau professionnel lame dentelée
 Kuchenmesser
 Cuchillo pastel profesional dentado

Acciaio Inox 18/10 - St. Steel 18/10

| | mm | in | spessore / thickness |
|---------------|-----|--------|----------------------|
| 903 05 91 788 | 297 | 11,3/4 | 2.5 mm |

seghettato / serrated



Pala torta professionale

Professional cake server
 Pelle à gâteau professionnelle
 Tortenschaufel
 Pala pastel profesional

Acciaio Inox 18/10 - St. Steel 18/10

| | mm | in | spessore / thickness |
|---------------|-----|--------|----------------------|
| 903 05 91 799 | 297 | 11,3/4 | 2.5 mm |



Pala torta seghettata professionale

Professional serrated-edge cake server
 Pelle à gâteau dentelée professionnelle
 Tortenschaufel
 Pala pastel profesional dentada

Acciaio Inox 18/10 - St. Steel 18/10

| | mm | in | spessore / thickness |
|---------------|-----|--------|----------------------|
| 903 05 91 786 | 297 | 11,3/4 | 2.5 mm |



Spatola crepes professionale

Professional crepes server
 Spatule à crêpes professionnelle
 Crepesschaufel
 Pala crepes profesional

Acciaio Inox 18/10 - St. Steel 18/10

| | mm | in | spessore / thickness |
|---------------|-----|--------|----------------------|
| 903 05 91 065 | 292 | 11,1/2 | 2.5 mm |



Molla gastronomica

Culinary tongs
 Pince culinaire
 Gastronomischer Frühling
 Pinzas culinario

Acciaio Inox 18/10 - St. Steel 18/10

| | mm | in |
|-----------|-----|-------|
| C1 180 00 | 155 | 6,1/8 |



Molla ghiaccio de luxe

De luxe ice tongs
 Pince à glaçons de luxe
 Eiszange de luxe
 Pinzas hielo de luxe

Acciaio Inox - St. Steel

| | mm | in |
|---------------|-----|-------|
| 903 06 81 MGD | 156 | 6,1/8 |



Molla ghiaccio Lux

Lux ice tongs
Pince à glace Lux
Lux Eiszange
Pinzas hielo Lux

Acciaio Inox 18/10 - St. Steel 18/10

| | mm | in |
|------------|-----|-------|
| 9030581001 | 126 | 4,7/8 |



Molla insalata o vegetali Lux

Lux salad/vegetable tongs
Pince à légumes Lux
Lux Gemüsezange
Pinza para ensalada Lux

Acciaio Inox 18/10 - St. Steel 18/10

| | mm | in |
|------------|-----|-------|
| 9030581004 | 210 | 8,1/4 |



Molla pane Lux

Lux bread tongs
Pince à pain Lux
Lux Brotzange
Pinzas pan Lux

Acciaio Inox 18/10 - St. Steel 18/10

| | mm | in |
|------------|-----|-------|
| 9030581007 | 210 | 8,1/4 |



Forbici servire pane Lux

Lux bread serving scissors tongs
Pince ciseaux à servir pain Lux
Lux Brot Servierzange
Pinzas tijeras para servir pan Lux

Acciaio Inox 18/10 - St. Steel 18/10

| | mm | in |
|------------|-----|-------|
| 9030581FPA | 250 | 8,7/8 |



Forbici servire pasticceria Lux

Lux pastry serving scissors
Ciseaux à servir gâteau Lux
Tijeras para servir pastelería Lux
Lux Gebäck-Servierzange

Acciaio Inox 18/10 - St. Steel 18/10

| | mm | in |
|------------|-----|-------|
| 9030581FPS | 210 | 8,1/4 |



Forbici servire arrosto Lux

Lux roast serving scissors tongs
Ciseaux à servir rôti Lux
Tijeras para servir asado Lux
Lux Fleisch-Servierzange

Acciaio Inox 18/10 - St. Steel 18/10

| | mm | in |
|------------|-----|-------|
| 9030581FAR | 250 | 8,7/8 |



Molla arrosto Modern

Modern roast tongs
Pince à rôti Modern
Modern fleischzange
Pinzas asado Modern

Acciaio Inox - St. Steel

| | mm | in |
|---------------|-----|-------|
| 903 05 81 MAR | 250 | 8,7/8 |



Molla dolci Modern

Modern cake tongs
Pince à gâteaux Modern
Modern gebäckzange
Pinzas postre Modern

Acciaio Inox - St. Steel

| | mm | in |
|---------------|-----|-------|
| 903 05 81 MDO | 250 | 8,7/8 |



Molla ghiaccio Modern

Modern ice tongs
Pince à glaçons Modern
Modern eiszange
Pinzas hielo Modern

Acciaio Inox - St. Steel

| | mm | in |
|---------------|-----|-------|
| 903 05 81 MGH | 200 | 7,7/8 |



Molla spaghetti Modern

Modern spaghetti tongs
Pince à spaghetti Modern
Modern spaghettizange
Pinzas spaghetti Modern

Acciaio Inox - St. Steel

| | mm | in |
|---------------|-----|-------|
| 903 05 81 MSP | 250 | 8,7/8 |



Molla insalata Long

Long salad tongs
Pince à salade Long
Long salatzange
Pinzas ensalada Long

Acciaio Inox - St. Steel

| | mm | in |
|---------------|-----|--------|
| 903 05 81 MIN | 270 | 10,5/8 |

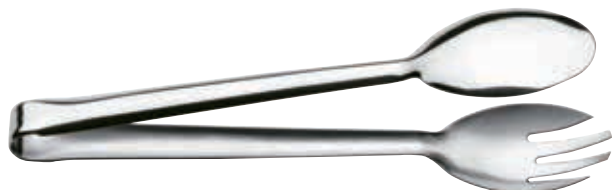

Molla pasta Long

Long pasta tongs
Pince à pâtes Long
Long pastazange
Pinzas pasta Long

Acciaio Inox - St. Steel

| | mm | in |
|---------------|-----|--------|
| 903 05 81 MPA | 270 | 10,5/8 |



Molla multiuso Long

Long multipurpose tongs
Pince à servir Long
Long multipurposezange
Pinzas para servir Long

Acciaio Inox - St. Steel

| | mm | in |
|---------------|-----|--------|
| 903 05 81 MMU | 295 | 11,5/8 |



Molla Universal Long

Universal Long tongs
Pince Universal Long
Long Universalzange
Pinzas Universal Long

Acciaio Inox - St. Steel

| | mm | in |
|---------------|-----|--------|
| 903 05 81 MUN | 270 | 10,5/8 |



Molla pane Cosmos

Cosmos bread tongs
Pince à pain Cosmos
Brotzange Cosmos
Pinzas pan Cosmos

Acciaio Inox/Nylon - St. Steel/ Nylon

| | mm | in |
|--------------------|-----|-------|
| ● V53 05 81 MPA 15 | 225 | 8,7/8 |



Molla spaghetti Cosmos

Cosmos spaghetti tongs
Pince à spaghetti Cosmos
Spaghettizange Cosmos
Pinzas spaghetti Cosmos

Acciaio Inox/Nylon - St. Steel/ Nylon

| | mm | in |
|--------------------|-----|-------|
| ● V53 05 81 MSP 15 | 230 | 9,1/8 |



Molla arrosto Cosmos

Cosmos roast tongs
Pince à rôti Cosmos
Braten/Fleischzange Cosmos
Pinzas asado Cosmos

Acciaio Inox/Nylon - St. Steel/ Nylon

| | mm | in |
|--------------------|-----|-------|
| ● V53 05 81 MAR 15 | 220 | 8,5/8 |



Molla dolce Cosmos

Cosmos cake tongs
Pince à gâteau Cosmos
Gebäckzange Cosmos
Pinzas postre Cosmos

Acciaio Inox/Nylon - St. Steel/ Nylon

| | mm | in |
|--------------------|-----|-------|
| ● V53 05 81 MDO 15 | 220 | 8,5/8 |



Molla ghiaccio Cosmos

Cosmos ice tongs
Pince à glace Cosmos
Eiszange Cosmos
Pinzas hielo Cosmos

Acciaio Inox/Nylon - St. Steel/ Nylon

| | mm | in |
|--------------------|-----|-------|
| ● V53 05 81 MGH 15 | 214 | 8,3/8 |



Molla ghiaccio/zucchero piccola Basic

Basic ice/sugar tongs small
Pince à glaçons petite Basic
Basic Eiszange - klein
Pinzas hielo pequeñas Basic

Acciaio Inox - St. Steel

| | mm | in |
|---------------|-----|-------|
| 903 06 81 MGP | 118 | 4,3/4 |



Molla pane Basic

Basic bread tongs
Pince à pain Basic
Basic Brotzange
Pinzas pan Basic

Acciaio Inox - St. Steel

| | mm | in |
|---------------|-----|-------|
| 903 06 81 MPA | 200 | 7,7/8 |



Molla spaghetti Basic

Basic spaghetti tongs
Pince à spaghetti Basic
Basic Spaghettizange
Pinzas spaghetti Basic

Acciaio Inox - St. Steel

| | mm | in |
|---------------|-----|-------|
| 903 06 81 MSP | 202 | 7,7/8 |



Molla dolci Basic

Basic cake tongs
Pince à gâteau Basic
Basic Gebäckzange
Pinzas postre Basic

Acciaio Inox - St. Steel

| | mm | in |
|---------------|-----|-------|
| 903 06 81 MDL | 189 | 7,1/2 |



Molla arrosto Basic

Basic roast tongs
Pince à rôti Basic
Basic Fleisch/Servierzange
Pinzas asado Basic

Acciaio Inox - St. Steel

| | mm | in |
|---------------|-----|-------|
| 903 06 81 MAR | 210 | 8,1/4 |



Molla universale Basic

Basic universal tongs
Pince universelle Basic
Basic Universalzange
Pinzas universales Basic

Acciaio Inox - St. Steel

| | mm | in |
|---------------|-----|-------|
| 903 06 81 MUN | 235 | 9,1/4 |



Forbici insalata Basic

Basic salad tongs (scissors type)

Pince ciseaux à salade Basic

Basic Salatzange

Pinzas ensalada tipo tijeras Basic

Acciaio Inox - St. Steel

| | mm | in |
|---------------|-----|-------|
| 903 06 81 FIN | 200 | 7,7/8 |



Paletta raccoglibriciole

Crumb sweeper

Pelle ramasse-miettes

Krümelsammler

Pala recogemigas

Acciaio Inox 18/10 - St. Steel 18/10

| | mm | in |
|---------------|-----|-------|
| 903 05 91 939 | 160 | 6,1/4 |



Campanello reception

Reception bell

Sonette de réception

Hotelglocke

Timbre recepciòn

Acciaio Inox - St. Steel

AVARI 112



Spillone pizzeria

Pizza pin

Épingle pour commandes pizzeria

Pizzeria Stecknadel

Agujón para hojas pedidos pizzeria

Acciaio Inox - St. Steel

AVARI 086



Forbici dolci Basic

Basic cake tongs (scissors type)

Pince ciseaux à gâteaux Basic

Basic Scherenzange

Pinzas postre tipo tijeras Basic

Acciaio Inox - St. Steel

| | mm | in |
|---------------|-----|-------|
| 903 06 81 FDO | 195 | 7,5/8 |



Forchettone spaghetti

Spaghetti serving fork

Fourchette à servir spaghetti

Spaghettigabel

Tenedor servir spaghetti

Acciaio Inox 18/10 - St. Steel 18/10

| | mm | in |
|---------------|-----|----|
| 903 05 91 792 | 278 | 11 |



Schiaccianoci forgiato

Nut cracker - forged

Casse noix forgé

Nußknacker geschmieden

Cascanueces forjado

Acciaio Inox - St. Steel

| | mm | in |
|-----------|-----|----|
| AVARI 117 | 150 | 6 |



INSPIRATION

INSPIRATION

INSPIRATIONAL BURGER

Vassoio da banco/bar pasticceria

Bar/pastry tray
Plateau bar/pâtisserie
Konditoreiplatte
Bandeja bar/pastelería

Acciaio inox 18/10 - St. steel 18/10

| | cm | H. cm | in | H. in |
|---------------|----------|-------|--------------|-------|
| V01 05 23 P08 | 35x20 sp | H.0,8 | 13.3/4x7.7/8 | 0,31 |
| V01 05 23 P02 | 60x10 sp | H.0,8 | 23.5/8x4 | 0,31 |

Coltello Angus

Angus steak knife
Couteau à bifteck Angus
Angus Steakmesser
Cuchillo carne Angus

Acciaio Inox - St. Steel / POM

| | cm | in |
|--------|----|----|
| CAN 55 | 23 | 9 |

Forchetta Marea

Marea fork
Fourchette Marea
Marea Gabel
Tenedor Marea

Acciaio Inox 18/10 - St. Steel 18/10

| | cm | in |
|--------|------|----|
| CE4 02 | 20,4 | 8 |

Macinapepe/spargisale

Pepper mill/salt shaker
Moulin à poivre/salière
Pfeffermühle/Pfefferstreuer
Molinillo pimienta/salero

Acrilico + Ceramica + Al / Acrylic + Ceramic + Aluminum

| | ø cm | ø in | H. cm | H. in |
|-------------|------|-------------|-------|-------|
| AVARI 075 A | 4x4 | 1,5/8x1,5/8 | 12 | 4,3/4 |
| AVARI 075 B | 4x4 | 1,5/8x1,5/8 | 9 | 3,1/2 |

Macinapepe /
spargisale

Coltello
Angus

Forchetta
Marea



A photograph of a food tray set on a light blue perforated metal table. The tray is silver and contains two burgers on sesame seed buns, a stack of three potato slices, and three small white bowls of side dishes: one with mixed peppers, one with sliced onions and tomatoes, and one with pickles. A crystal glass is also on the tray. The background is a green lawn.

Vassoio da banco/
bar pasticceria

INSPIRATIONAL SUSHI



Piatto refrigerato Celsius-Ice

Celsius-Ice dish, refrigerated
Plat réfrigéré Celsius-Ice
Celsius-Ice Servierplatte, gekühlt
Fuente refrigerada Celsius-Ice

Acciaio inox 18/10 - St. steel 18/10

| | ø cm | H. cm | ø in | H. in |
|------------|------|-------|--------|-------|
| CI 22 600R | 32 | 3,5 | 12,5/8 | 1,3/8 |

Bacchette sushi Ergo

Ergo sushi chopsticks
Baguettes à sushi Ergo
Ergo Sushi stäbchen
Palillos para sushi Ergo

Inox 18/10 - St. Steel

| | cm | in |
|-----------------|----|----|
| 903 05 84 660 X | 23 | 9 |

Set 2 pz - 2-pc set

Poggiabastoncini Ergo

Ergo cutlery stand
Porte - couverts Ergo
Ergo Besteck Bänke
Posa cubiertos Ergo

Inox 18/10 - St. Steel

| | cm | in |
|---------------|----|-------|
| 903 05 84 662 | 6 | 2,3/8 |

**Piatto
refrigerato**



**Poggiabastoncini
Ergo**

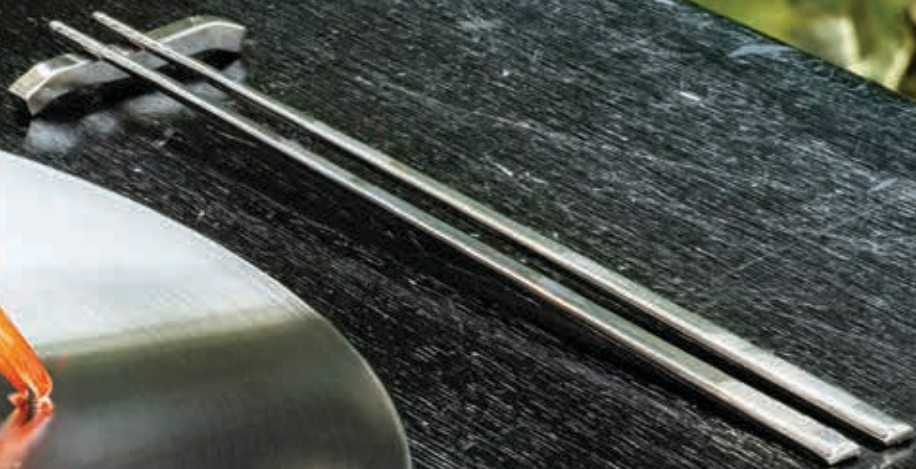

**Bacchette
sushi Ergo**



INSPIRATIONAL STEAK



Vassoio grill rettangolare

Vassoio grill rettangolare Celsius

Celsius grill tray, rectangular
Plateau grill rectangulaire Celsius
Celsius grilltablett rechteckig
Bandeja grill rectangular Celsius

Acciaio Inox 18/10 - St. Steel 18/10

Alluminio - Aluminum

Legno di betulla - Birch wood

| | cm | in |
|---------------|-------|--------------|
| V89 05 SE 001 | 29x20 | 11,1/2x7,7/8 |

Forchetta carne Ergo

Ergo steak fork
Fourchette à bifteck Ergo
Ergo Steakgabel
Tenedor carne Ergo

Acciaio inox 18/10 - St. Steel 18/10

| | cm | in |
|-------|----|-------|
| CE552 | 20 | 7,7/8 |

Coltello carne Safari

Safari steak knife
Couteau à bifteck Safari
Safari Steakmesser
Cuchillo carne Safari

Acciaio + legno - St. Steel + wood

| | cm | in |
|------------|------|-------|
| CE5 A5 5LC | 23,5 | 9,1/4 |



Forchetta carne
Ergo

Coltello carne
Safari

INSPIRATIONAL SEAFOOD



Piatto refrigerato

Piatto refrigerato Celsius-Ice

Celsius-Ice Thermal dish
Plat réfrigéré Celsius-Ice
Celsius-Ice Fuente refrigerada
Servierplatte, gekühlt Celsius-Ice

Acciaio Inox 18/10 - St. Steel 18/10

| | ø cm | ø in | H. cm | h in |
|------------|------|------|-------|-------|
| V330522001 | 23 | 9 | 4,5 | 1,3/4 |

Matisse forchetta ostriche

Matisse oyster fork
Fouchette à crustacés Matisse
Tenedor ostras Matisse
Austerngabel Matisse

Acciaio Inox 18/10 - St,Steel 18/10

| | cm | in |
|-------|------|-------|
| CF164 | 15,6 | 6,1/8 |



Matise forchetta
ostriche

SHARING HAPPY HOURS

Alzata presentazione corten Domino

Domino podium, corten
Présentoir Domino corten
Domino Podium, corten
Soporte presentación Domino corten

Acciaio Verniciato - Varnished Steel

| | cm | H. cm | in | H. in |
|------------|-------|-------|--------------|-------|
| V331842020 | 20x40 | 9 | 7,7/8x15,3/4 | 3,1/2 |

Gres Corten mix

| | cm | in |
|------------|-------|-------------|
| V332142002 | 20x20 | 7,7/8x7,7/8 |

Cornice scura Domino

Domino frame, dark
Cadre foncé Domino
Domino Rahmen, dunkel
Marco oscuro Domino

Legno Massello - Solid Wood

| | cm | H. cm | in | H. in |
|------------|-------|-------|---------------|-------|
| V330442151 | 20x40 | 5 | 7,7/8x15,3/4 | 2 |
| V330442153 | 40x40 | 5 | 15,3/4x15,3/4 | 2 |

Tagliere formaggi color noce Domino

Domino cheese cutting board, walnut colour
Planche à découper fromages couleur noix Domino
Domino Käsebrett, Walnuss
Tabla de cortar quesos color nuez Domino

Legno massello - Solid wood

| | cm | H. cm | in | H. in |
|------------|-------|-------|--------------|-------|
| V330471003 | 20x40 | 2 | 7,7/8x15,3/4 | 0,3/4 |

Vaso in vetro con coperchio

Glass jar with lid
Pot en verre avec couvercle
Jarrón de vidrio con tapa
Glasdose mit Deckel

Vetro - Glass

| | ø cm | H. cm | ø in | H. in |
|------------|------|-------|-------|-------|
| 4041031304 | 14 | 17,5 | 5,1/2 | 6,7/8 |



Vaso in vetro
con coperchio

Gres Corten mix



Alzata presentazione
corten Domino

Tagliere formaggi
color noce Domino

Cornice scura
Domino

SHARING SEAFOOD

Piatto refrigerato

Thermal dish
Plat réfrigéré
Fuente refrigerada
Servierplatte, gekühlt

Acciaio Inox 18/10 - St. Steel 18/10

| | ø cm | ø in |
|---------------|------|------|
| V33 05 22 001 | 23 | 9 |

Piatto tondo Imperfetto

Imperfetto round plate
Plat rond Imperfetto
Plato redondo Imperfetto
Imperfetto Teller rund

Acciaio Inox 18/10 - St. Steel 18/10

| | ø cm | ø in |
|---------------|------|--------|
| Z33 28 24 002 | 36 | 14,1/8 |
| Z33 28 24 003 | 42 | 16,1/2 |

Supporto in filo per piatto refrigerato

Wire stand for thermal dish
Support en fil d'acier pour plat réfrigéré
Soporte en hilo de acero para fuente redonda
Drahtständer für Thermoplatte

Acciaio Inox 18/10 - St. Steel 18/10

| | H base cm | H base in |
|---------------|-----------|-----------|
| Z33 80 42 001 | 28 | 11 |

Stiletto aragosta

Lobster pick
Fourchette à homard
Langustegabel
Tenedor langosta

Acciaio Inox 18/10 - St. Steel 18/10

| | cm | in |
|---------------|------|-------|
| 903 05 84 659 | 20,2 | 7,7/8 |

Pinza aragosta forgiata

Lobster cracker, forged
Pince à homard forgé
Langustezange - geschmieden
Pinzas langosta forjadas

Acciaio Inox - St. Steel

| | cm | in |
|---------------|----|-------|
| 305 05 91 658 | 19 | 7,1/2 |

Piattino per finger food

Small dish for finger food
Petit plat pour finger food
Platito para finger food
Schale klein für Fingerfood

Acciaio Inox 18/10 - St. Steel 18/10

| | ø cm | ø in |
|------------|------|-------|
| V390521001 | 9 | 3,1/2 |



Pinza e stiletto aragosta



Piatto tondo Imperfetto

Supporto in filo per piatto refrigerato

Piatto refrigerato

Piatto tondo Imperfetto

Piatto refrigerato

Piattino per finger food

SHARING STEAKS

Vassoio grill ovale Celsius

Celsius oval grill tray
Plateau grill oval Celsius
Celsius Grilltablett oval
Bandeja grill oval Celsius

Acciaio Inox 18/10 - St. Steel 18/10

Alluminio - Aluminum

Legno di betulla - Birch wood

| | cm | in |
|---------------|-------|-----------|
| V89 05 SE 004 | 38x34 | 15x13,3/8 |

Forchetta fiorentina

Fiorentina steak fork
Fourchette à bifteck Fiorentina
Fiorentina Steakgabel
Tenedor carne Fiorentina

Acciaio Inox 18/10 - St. Steel 18/10

| | cm | in |
|--------|------|----|
| CFI 02 | 20,4 | 8 |

Coltello carne Safari

Safari steak knife
Couteau à bifteck Safari
Safari Steakmesser
Cuchillo carne Safari

Acciaio + legno - St. steel + wood

| | cm | in |
|------------|------|-------|
| CE5 A5 5LC | 23,5 | 9,1/4 |





**Coltello carne
Safari**

Vassoio grill ovale

**Forchetta
carne Fiorentina**

SHARING DESSERTS

Alzata pasticceria 1 piano

Petit four stand
Support à pâtisserie
Petits-Fours-Ständer
Presentación pastelería

Acciaio Inox 18/10 - St. Steel 18/10

| | ø cm | H. cm | ø in | H. in |
|---------------|------|-------|-------|-------|
| V36 05 41 012 | 12 | 13 | 4,3/4 | 5,1/8 |
| V36 05 41 016 | 16 | 13 | 6,1/4 | 5,1/8 |

Alzata pasticceria 2 piani

2-tier petit four stand
Support à pâtisserie à 2 étages
Petits-fours ständer 2-stufig
Presentación pastelería 2 pisos

Acciaio Inox 18/10 - St. Steel 18/10

| | ø cm | H. cm | ø in | H. in |
|---------------|-------|-------|-------------|-------|
| V36 05 41 201 | 16-12 | 17 | 6,1/4-4,3/4 | 6.3/4 |

Alzata pasticceria 3 piani

3-tier petit four stand
Support à pâtisserie à 3 étages
Kuchenständer 3-stufig
Presentación pastelería 3 pisos

Acciaio Inox 18/10 - St. Steel 18/10

| | ø cm | H. cm |
|---------------|-------------------|--------|
| | 22-16-12 | 30 |
| | ø in | H. in |
| V36 05 41 301 | 8,5/8-6,1/4-4,3/4 | 11.3/4 |

Piattino per finger food

Small dish for finger food
Petit plat pour finger food
Platito para finger food
Schale klein für Fingerfood

Acciaio Inox 18/10 - St. Steel 18/10

| | ø cm | ø in |
|------------|------|-------|
| V390521001 | 9 | 3,1/2 |

Alzata pasticceria
1 piano



A three-tiered silver serving stand is the central focus, showcasing a variety of pastries and desserts. The top tier holds a single white macaron. The middle tier is filled with several bright red macarons. The bottom tier features a large white dome-shaped dessert with a blueberry and a slice of orange, a collection of colorful macarons (red, yellow, purple, orange), and three small round tarts with different fillings. The stand is set on a light green table. In the background, there are lush green plants and a blurred view of an outdoor setting.

**Alzata pasticceria
3 piani**

**Alzata pasticceria
2 piani**

**Piattino per
finger food**



LIGHTING

LIGHTING

**Lampada ricaricabile personalizzabile Logo**

Logo customizable rechargeable lamp
Lampe rechargeable personnalisable Logo
Lampe, wiederaufladbar, personalisiertes Logo
Lámpara recargable personalizable Logo

**Alluminio verniciato - Varnished Aluminum /
Policarbonato - polycarbonate**

| | ø mm | ø in | H. mm | H. in |
|------------|------|-------|-------|--------|
| 9101317004 | 120 | 4,3/4 | 375 | 14,3/4 |



165918

38079

MILNERS' PATENT



A
Dima di plastica
Plastic template



B
Fascia opacizzante con texture
Fabric neutral decorative band



C
Cilindro superiore trasparente
Top transparent cylinder

D
Cilindro inferiore luminoso
Bright bottom cylinder

Illuminare è arredare: la giusta illuminazione è importante dal punto di vista estetico e funzionale per la valorizzazione degli spazi.

La lampada LOGO è personalizzabile e questo ti consente di valorizzare il tuo stile e la tua personalità in tutti gli ambienti.

Nella confezione di LOGO è contenuta una dima di plastica trasparente (A) per poter ritagliare stoffe o carta (stampabile su un formato A3) da inserire sotto la calotta di plastica della fonte luminosa, permettendone così la personalizzazione.

La confezione comprende anche una fascia decorativa neutra (B) in uno speciale tessuto (pre-inserito) della dimensione corretta (stessa dimensione della dima di plastica). Questa fascia, inserita a contatto con la lampada, prima della carta opportunamente ritagliata (E), conferirà matericità ed eleganza a qualunque materiale vorrete usare per la personalizzazione.

Lighting is furnishing: the right lights are important from the aesthetic and functional point of view in order to enhance spaces. The lamp LOGO is customizable, and that allows you to make the most of your style and your personality in all the environments.

LOGO comes with a clear plastic template (A), in order to cut fabric or paper (printable on A3) to be inserted under the plastic cover of the light source, thus allowing customization.

The package includes a special fabric neutral decorative band (B) (previously placed) whose dimension is correct (same dimensions as the plastic template). Such band, in contact with the lamp, before your paper appropriately cut (E), gives material consistency and elegance to any material you will want to use for customization.

1

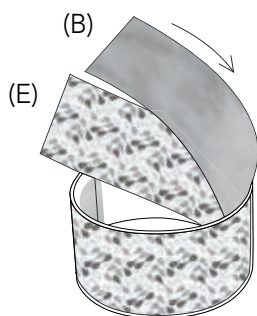

2

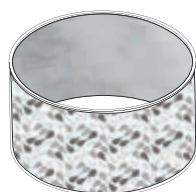

3

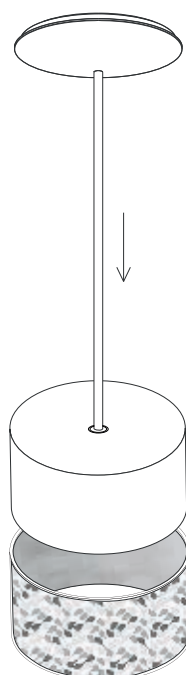

4

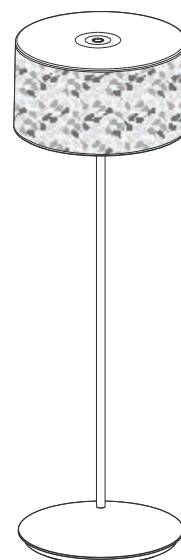







Lampada ricaricabile Tempo bianca

Tempo rechargeable lamp, white
 Lampe rechargeable Tempo blanche
 Lampe, wiederaufladbar, Tempo, weiß
 Lámpara recargable Tempo blanca

Alluminio verniciato - Varnished Aluminum

| | ø mm | ø in | H. mm | H. in |
|------------|------|-------|-------|-------|
| 9101317001 | 100 | 3,7/8 | 280 | 11 |



Lampada ricaricabile Tempo corten

Tempo rechargeable lamp, corten
 Lampe rechargeable Tempo corten
 Lampe, wiederaufladbar, Tempo, corton
 Lámpara recargable Tempo corten

Alluminio verniciato - Varnished Aluminum

| | ø mm | ø in | H. mm | H. in |
|------------|------|-------|-------|-------|
| 9105517001 | 100 | 3,7/8 | 280 | 11 |



Lampada ricaricabile Tempo antracite

Tempo rechargeable lamp, anthracite
 Lampe rechargeable Tempo anthracite
 Lampe, wiederaufladbar, Tempo, anthrazit
 Lámpara recargable Tempo antracita

Alluminio verniciato - Varnished Aluminum

| | ø mm | ø in | H. mm | H. in |
|------------|------|-------|-------|-------|
| 9107817001 | 100 | 3,7/8 | 280 | 11 |



Lampada ricaricabile Resort bianca

Resort rechargeable lamp, white
 Lampe rechargeable Resort blanche
 Lampe, wiederaufladbar, Resort, weiß
 Lámpara recargable Resort blanca

Alluminio verniciato - Varnished Aluminum

| | LxP mm | LxP in | H. mm | H. in |
|------------|---------|--------|-------|--------|
| 9101317002 | 100x100 | 4x4 | 340 | 13,3/4 |



Lampada ricaricabile Resort corten

Resort rechargeable lamp, corten
 Lampe rechargeable Resort corten
 Lampe, wiederaufladbar, Resort, corton
 Lámpara recargable Resort corten

Alluminio verniciato - Varnished Aluminum

| | LxP mm | LxP in | H. mm | H. in |
|------------|---------|--------|-------|--------|
| 9105517002 | 100x100 | 4x4 | 340 | 13,3/4 |



Lampada ricaricabile Resort antracite

Resort rechargeable lamp, anthracite
 Lampe rechargeable Resort anthracite
 Lampe, wiederaufladbar, Resort, anthrazit
 Lámpara recargable Resort antracita

Alluminio verniciato - Varnished Aluminum

| | LxP mm | LxP in | H. mm | H. in |
|------------|---------|--------|-------|--------|
| 9107817002 | 100x100 | 4x4 | 340 | 13,3/4 |







Lampada ricaricabile Resort Maxi bianca

Resort Maxi rechargeable lamp, white
 Lampe rechargeable Resort Maxi blanche
 Lampe, wiederaufladbar, Resort Maxi, weiß
 Lámpara recargable Resort Maxi blanca

Alluminio verniciato - Varnished Aluminum

| | LxP mm | LxP in | H. mm | H. in |
|------------|---------|-------------|-------|--------|
| 9101317003 | 140x140 | 5,1/2x5,1/2 | 540 | 21,1/4 |



Lampada ricaricabile Resort Maxi corten

Resort Maxi rechargeable lamp, corten
 Lampe rechargeable Resort Maxi corten
 Lampe, wiederaufladbar, Resort Maxi, corton
 Lámpara recargable Resort Maxi corten

Alluminio verniciato - Varnished Aluminum

| | LxP mm | LxP in | H. mm | H. in |
|------------|---------|-------------|-------|--------|
| 9105517003 | 140x140 | 5,1/2x5,1/2 | 540 | 21,1/4 |



Lampada ricaricabile Resort Maxi antracite

Resort Maxi rechargeable lamp, anthracite
 Lampe rechargeable Resort Maxi anthracite
 Lampe, wiederaufladbar, Resort Maxi, anthrazit
 Lámpara recargable Resort Maxi antracita

Alluminio verniciato - Varnished Aluminum

| | LxP mm | LxP in | H. mm | H. in |
|------------|---------|-------------|-------|--------|
| 9107817003 | 140x140 | 5,1/2x5,1/2 | 540 | 21,1/4 |

Lampada a batterie ricaricabile (tramite base di ricarica e caricatore inclusi). È una lampada di grande qualità, costruita con materiali nobili e inalterabili: alluminio pressofuso e alluminio estruso. Verniciata con polveri epossidiche termoindurenti.

Rechargeable battery lamp (charging base and charger are included). It is a high-quality lamp, made of durable and noble materials: die-cast aluminum and extruded aluminum. It is thermosetting epoxy powder coated.



| | | |
|--|--|--|
| Misure / Dimensions | Base Ø12, H 37cm | Base ø 10cm, H 28cm |
| Colori disponibili Available colours | Bianco White | Bianco, corten, antracite White, corten, anthracite |
| Dimmerabilità Dimmability | La lampada è dotata di un interruttore a contatto che consente l'accensione, lo spegnimento e la variabilità della potenza luminosa. The lamp is provided with a contact on/off switch, which allows to change the light intensity as well. | |
| Potenza / Wattage | 2,2 watt | 2,5 watt |
| Volt | 3,7 (DC, corrente continua) / 3,7 (DC, direct current) | |
| Flusso luminoso reale Actual luminous flux | 230 lumen | 200 lumen |
| Batteria Battery | Litio, 1 batteria da 3800mA Lithium, 1 battery, 3800 mA/h each | Litio, 2 batterie da 2200 mA/h cadauna Lithium, 2 batteries, 2200 mA/h each |
| Tempo di ricarica Charging time | da 6 a 8 ore from 6 to 8 hours | da 6 a 8 ore from 6 to 8 hours |
| Autonomia / Autonomy | circa 9 ore / 9 hours approximately | circa 10 ore / 10 hours approximately |
| Protezione contro gli agenti atmosferici Protection against natural elements | Protezione contro polvere e pioggia (IP54). Il caricatore e la base di ricarica non sono protetti dalla pioggia e vanno utilizzati solo all'interno. Protection against dust and rain (IP54). | |

La lampada è costruita da materiali riciclabili (alluminio, acciaio, tecnopolimero)
The lamp is made of recyclable materials (aluminum, steel, technopolymer)

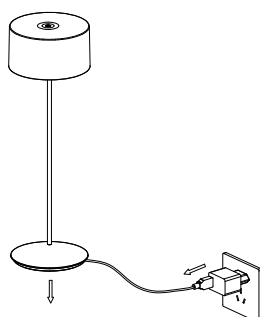
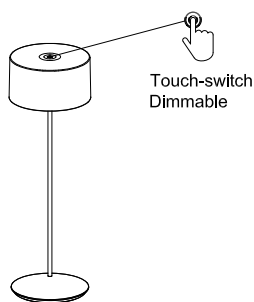

CAVO DI RICARICA PER LOGO
CHARGING CABLE FOR LOGO

Lampada a batterie ricaricabile (tramite base di ricarica e caricatore inclusi). È una lampada di grande qualità, costruita con materiali nobili e inalterabili: alluminio pressofuso e alluminio estruso. Verniciata con polveri epossidiche termoindurenti.

Rechargeable battery lamp (charging base and charger are included). It is a high-quality lamp, made of durable and noble materials: die-cast aluminum and extruded aluminum. It is thermosetting epoxy powder coated.



| | |
|--|--|
| Base 10 x 10cm, H 34cm | Base 14 x 14cm, H 54cm |
| Bianco, corten, antracite White, corten, anthracite | Bianco, corten, antracite White, corten, anthracite |
| La lampada è dotata di un interruttore a contatto che consente l'accensione, lo spegnimento e la variabilità della potenza luminosa. The lamp is provided with a contact on/off switch, which allows to change the light intensity as well. | |
| 2,2 watt | 2,2 watt |
| 3,7 (DC, corrente continua) / 3,7 (DC, direct current) | |
| 180 lumen | 180 lumen |
| Litio, 2 batterie da 2200 mA/h cadauna Lithium, 2 batteries, 2200 mA/h each | Litio, 2 batterie da 2200 mA/h cadauna Lithium, 2 batteries, 2200 mA/h each |
| da 6 a 8 ore from 6 to 8 hours | da 6 a 8 ore from 6 to 8 hours |
| circa 12 ore / 12 hours approximately | circa 12 ore / 12 hours approximately |

Protezione contro polvere e pioggia (IP54).

Il caricatore e la base di ricarica non sono protetti dalla pioggia e vanno utilizzati solo all'interno.

Protection against dust and rain (IP54).

La lampada è costruita da materiali riciclabili (alluminio, acciaio, tecnopolimero)

The lamp is made of recyclable materials (aluminum, steel, technopolymer)

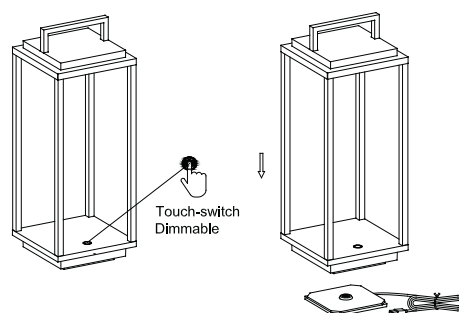
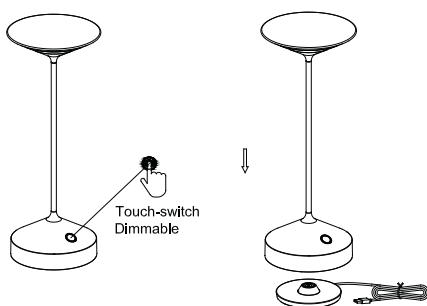

BASE DI RICARICA
CHARGING BASE

TAVOLA
NO
LA

TAVOLA



Centrotavola Imperfetto

Imperfetto centrepiece

Centre de table Imperfetto

Imperfetto, Tisch-Centerpiece

Centro de mesa Imperfetto

Inox 18/10 - St.Steel / Legno Massello - Solid Wood

| | ø cm | H base cm | ø in | H base in |
|------------|------|-----------|--------|-----------|
| V333224001 | 31 | 4 | 12,1/4 | 1,5/8 |
| V333224002 | 36 | 4 | 14,1/8 | 1,5/8 |
| V333224003 | 42 | 4 | 16,1/2 | 1,5/8 |

**Centrotavola Imperfetto**

Imperfetto centrepiece

Centre de table Imperfetto

Imperfetto, Tisch-Centerpiece

Centro de mesa Imperfetto

Inox 18/10 - St.Steel / Legno Massello - Solid Wood

| | ø cm | H base cm | ø in | H base in |
|------------|------|-----------|--------|-----------|
| V333224004 | 31 | 7 | 12,1/4 | 2,3/4 |
| V333224005 | 36 | 7 | 14,1/8 | 2,3/4 |
| V333224006 | 42 | 7 | 16,1/2 | 2,3/4 |



Piatto tondo Imperfetto

Imperfetto round plate
 Plat rond Imperfetto
 Plato redondo Imperfetto
 Imperfetto Teller rund

Acciaio Inox 18/10 - St. Steel 18/10

| | ø cm | ø in |
|---------------|------|--------|
| Z33 28 24 001 | 31 | 12,1/4 |
| Z33 28 24 002 | 36 | 14,1/8 |
| Z33 28 24 003 | 42 | 16,1/2 |

**Piatto fondo tondo crudité**

Crudité platter, deep, round
 Assiette à crudités creuse ronde
 Plato hondo redondo crudités
 Aufschnittplatte, tief, rund

Acciaio Inox 18/10 - St. Steel 18/10

| | ø cm | ø in |
|---------------|------|--------|
| Z33 28 42 T01 | 34 | 11,5/8 |
| Z33 28 42 T02 | 41 | 16,1/8 |

**Piatto refrigerato Celsius-Ice**

Celsius-Ice Thermal dish
 Plat réfrigéré Celsius-Ice
 Celsius-Ice Fuente refrigerada
 Servierplatte, gekühlt Celsius-Ice

Acciaio Inox 18/10 - St. Steel 18/10

| | ø cm | ø in | H. cm | H. in |
|---------------|------|------|-------|-------|
| V33 05 22 001 | 23 | 9 | 4,5 | 1,3/4 |

**Supporto in filo per piatto refrigerato**

Wire stand for thermal dish
 Support en fil d'acier pour plat réfrigéré
 Soporte en hilo de acero para fuente redonda
 Drahtständer für Thermoplatte

Acciaio Inox 18/10 - St. Steel 18/10

| | H base cm | H base in |
|---------------|-----------|-----------|
| Z33 80 42 001 | 28 | 11 |





Celsius

IDEALE PER SERVIRE
PERFECT TO SERVE



CARNE
MEAT



PESCE
FISH



VERDURE
VEGETABLES



PIZZA E NON SOLO
PIZZA & MORE

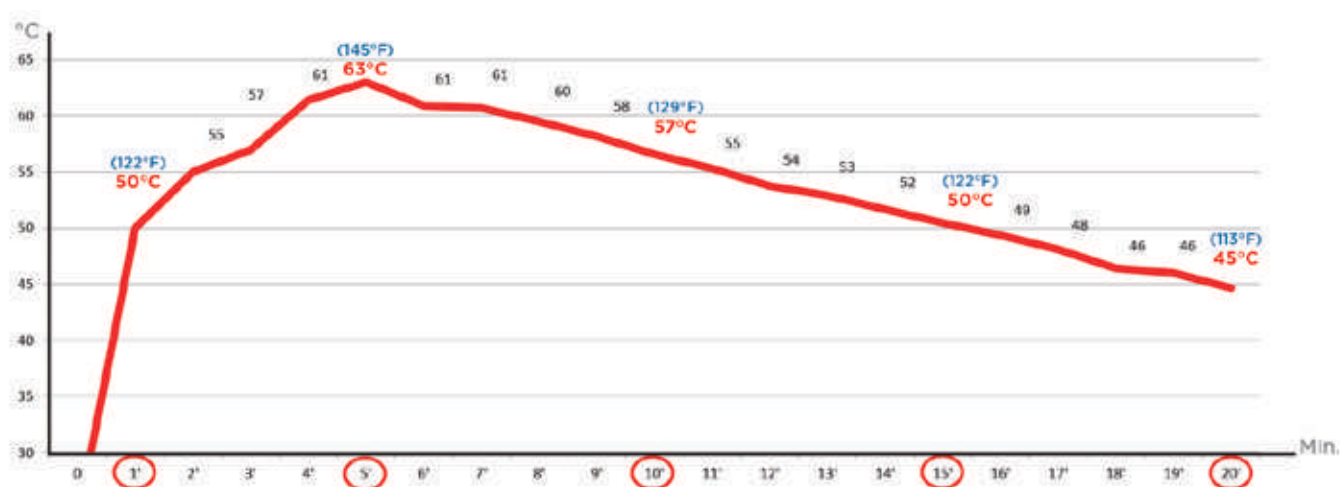

Celsius è il nuovo piatto che mantiene costante la temperatura delle pietanze senza continuare il processo di cottura, per conservare al meglio il gusto di ogni ricetta.

Design moderno ed essenziale, che si abbina a ogni mise en place e innovativa funzionalità grazie alla presa ergonomica della base in legno, che protegge dalle scottature.

La piastra in alluminio viene **riscaldata in forno**, regolando temperatura e tempo a seconda della pietanza, per poi essere posizionata sotto il piatto in acciaio che, a contatto con gli alimenti, **mantiene costante la temperatura** del cibo durante il pasto.

Celsius è un prodotto **igienico e di facile pulizia**: il piatto in acciaio (unica componente a contatto con gli alimenti) è comodamente lavabile in lavastoviglie, a differenza delle pietre ollari che assorbono i grassi, non sono lavabili e alterano lo stato di cottura delle pietanze.

Celsius è disponibile in quattro versioni per rispondere a ogni esigenza, dal singolo posto tavola ai momenti di convivialità, e in due forme adatte a diverse tipologie di pietanze come ad esempio le carni e la pizza.

Celsius. Per non servire più cibi freddi!

Celsius is the new plate that keeps food temperature constant without continuing the cooking process, to best preserve the taste of every recipe.

Modern and essential design, matching with every place setting, and innovative functionality, thanks to the ergonomic grip, and the wood base, that protects from burning.

The aluminum plate is **warmed into the oven**, adjusting temperature and time based on the food; then it is placed under the steel plate that, in contact with food, **keeps its temperature constant** during the meal.

Celsius is a healthy product and **easy to clean**: the steel plate (the only component in contact with food) is dishwasher safe while, for instance, soapstone, that absorbs fat, is not washable and alters food cooking.

Celsius comes in four versions to meet every need, from the individual place setting to the large gatherings, and in two different shapes, suitable for different foods, like meat and pizza.

Celsius. You will not serve cold food anymore!



Vassoio grill rettangolare Celsius

Celsius rectangular grill tray
 Plateau grill rectangulaire Celsius
 Celsius Grilltablett rechteckig
 Bandeja grill rectangular Celsius

| | cm | in |
|---------------|-------|--------------|
| V89 05 SE 001 | 29x20 | 11,1/2x7,7/8 |
| V89 05 SE 002 | 34x24 | 13,3/8x9,1/2 |

Piatto

Plate
 Plat
 Edelstahl Tablett rechteckig
 Plato

Acciaio Inox 18/10 - St. Steel 18/10

| | cm | in |
|---------------|-------|--------------|
| Z89 14 22 R01 | 29x20 | 9,7/8x7,1/4 |
| Z89 14 22 R02 | 34x24 | 11,5/8x8,1/2 |

Piastra alluminio

Aluminum plate
 Plaque aluminium
 Aluminiumplatte
 Placa aluminium

Alluminio - Aluminum

| | cm | in |
|---------------|---------|-------------|
| Z89 15 22 R01 | 19x12 | 7,1/2x4,3/4 |
| Z89 15 22 R02 | 24x15,5 | 9,1/2x6,1/8 |

Base rettangolare

Rectangular base
 Base rectangulaire
 Holzgestell rechteckig
 Base rectangular

Legno di betulla - Birch wood

| | cm | in |
|---------------|-------|--------------|
| Z89 19 22 R01 | 29x20 | 11,1/2x7,7/8 |
| Z89 19 22 R02 | 34x24 | 13,3/8x9,1/2 |





Vassoio grill ovale Celsius

Celsius oval grill tray
 Plateau grill oval Celsius
 Celsius Grilltablett oval
 Bandeja grill oval Celsius

| | cm | in |
|---------------|-------|-----------|
| V89 05 SE 003 | 28x32 | 1x12,5/8 |
| V89 05 SE 004 | 38x34 | 15x13,3/8 |

Piatto

Plate
 Plat
 Edelstahl Tablett oval
 Plato

Acciaio Inox 18/10 - St. Steel 18/10

| | ø cm | ø in |
|---------------|------|--------|
| Z89 14 22 T01 | 25,5 | 10 |
| Z89 14 22 T02 | 31,5 | 12,3/8 |

Piastra alluminio

Aluminum plate
 Plaque aluminium
 Aluminiumplatte
 Placa aluminium

Alluminio - Aluminum

| | ø cm | ø in |
|---------------|------|-------|
| Z89 15 22 T01 | 20 | 7,7/8 |
| Z89 15 22 T02 | 24 | 9,1/2 |

Base ovale

Oval base
 Base ovale
 Holzgestell oval
 Base oval

Legno di betulla - Birch wood

| | cm | in |
|---------------|-------|-----------|
| Z89 19 22 T01 | 28x32 | 1x12,5/8 |
| Z89 19 22 T02 | 38x34 | 15x13,3/8 |





Piatto refrigerato Celsius-Ice

Celsius-Ice thermal dish

Plat réfrigéré Celsius-Ice

Celsius-Ice Servierplatte, gekühlt

Fuente refrigerada Celsius-Ice

Acciaio inox 18/10 - St. steel 18/10

| | ø cm | H. cm | ø in | H. in |
|------------|------|-------|--------|-------|
| CI 22 600R | 32 | 3,5 | 12,5/8 | 1,3/8 |

Andamento Temperatura

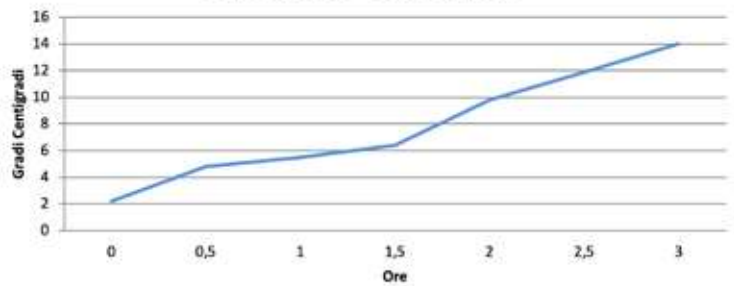

Portagrissini Tegola

Tegola breadstick holder
 Porte-gressins Tegola
 Tegola Contenedor palitos de pan
 Grissini-Korb Tegola

Acciaio Inox 18/10 - St. Steel 18/10

| | cm | in |
|---------------|--------|--------|
| V39 05 42 003 | 24x7,5 | 9,45x3 |

**Portagrissini/pane Tegola**

Tegola bread basket
 Corbeille à pain Tegola
 Tegola Cesta pan
 Brotkorb Tegola

Acciaio Inox 18/10 - St. Steel 18/10

| | cm | in |
|---------------|-------|----------|
| V39 05 42 001 | 24x16 | 9,45x6,3 |

**Portafrutta Tegola**

Tegola fruit bowl
 Plat à fruits Tegola
 Tegola Plato para fruta
 Obstschale Tegola

Acciaio Inox 18/10 - St. Steel 18/10

| | cm | in |
|---------------|-------|---------------|
| V39 05 42 002 | 27x27 | 10,5/8x10,5/8 |







Cestino pane e frutta Cacao con manico in pelle

Cacao bread and fruit basket - with leather handle
 Corbeille à pain et fruits Cacao - avec anses en cuir
 Cacao Brotkorb und Fruchtkakao - mit Ledergriff
 Cesto de pan y fruta Cacao - con asas de piel

Acciaio Inox 18/10 - St. Steel 18/10 + E.P. - E.L.

| | cm | in |
|---------------|-------|-----|
| V05 05 24 M18 | 18x18 | 7x7 |
| V05 05 24 M23 | 23x23 | 9x9 |

**Secchio cacao con manico in ecopelle**

Cacao bucket with leather handle
 Seau Cacao avec manche en cuir
 Champagnekühler mit Eimer Cacao (Griff aus Leder)
 Cubo Cacao con mango de cuero

Acciaio Inox 18/10 - St. Steel 18/10 + E.P. - E.L.

| | ø cm | H. cm | ø in | H. in |
|---------------|------|-------|-------|-------|
| V36 05 20 M01 | 19 | 19,5 | 7,1/2 | 7,5/8 |



Cestino pane rettangolare Square

Bread basket Square, rectangular
 Corbeille à pain rectangulaire Square
 Brotkorb Square, rechteckig
 Cesta pan rectangular Square

Acciaio Inox 18/10 - St. Steel 18/10
Cotone - Cotton

| | cm | in |
|---------------|-------|-------------|
| V76 05 24 002 | 20x12 | 7,7/8x4,3/4 |

**Cestino pane rettangolare Square**

Bread basket Square, rectangular
 Corbeille à pain rectangulaire Square
 Brotkorb Square, rechteckig
 Cesta pan rectangular Square

Acciaio Inox 18/10 - St. Steel 18/10
Cotone - Cotton

| | cm | in |
|---------------|-------|--------------|
| V76 05 24 003 | 27x12 | 10,5/8x4,3/4 |

**Cestino pane Gourmet**

Gourmet bread basket
 Corbeille à pain Gourmet
 Gourmet Brotkorb
 Cesta pan Gourmet
 Cestino pane Gourmet

Acciaio Inox 18/10 - St. Steel 18/10

| | cm | in |
|---------------|-------|-------------|
| 305 05 24 613 | 25x15 | 9,7/8x5,7/8 |





Cestino pane liscio Majorca

Mallorca bread basket, plain
 Corbeille à pain Mallorca
 Brotkorb Mallorca
 Cesta pan Mallorca lisa

Acciaio Inox 18/10 - St. Steel 18/10

| | cm | in |
|---------------|-----------|--------------|
| V05 05 24 L18 | 18,5x18,5 | 7,1/4 x7,1/4 |
| V05 05 24 L23 | 23x23 | 9x9 |



Cestino pane ovale

Bread basket, oval
 Corbeille à pain ovale
 Brotkorb, oval
 Cesta pan oval

Acciaio Inox 18/10 - St. Steel 18/10

| | cm | in |
|---------------|-------|------|
| V01 05 24 028 | 28x15 | 11x6 |



Cestino in filo agrumi

Citrus-fruit basket

Corbeille à agrumes

Obstkorb Edelstahl Draht für Zitrusfrüchte

Cesta cítricos

Acciaio Inox 18/10 - St. Steel 18/10

| | ø cm | H. cm | ø in | H. in |
|------------|-------|-------|-------|-------|
| 906 05 001 | 21 cm | 20 | 8,1/4 | 7,7/8 |

**Cestino frutta tondo in filo**

Fruit basket, round, wire

Corbeille a fruits ronde en fil d'acier

Drahtobstkorb, rund

Cesta frutas redonda en hilo

Acciaio Inox 18/10 - St. Steel 18/10

| | ø cm | H. cm | ø in | H. in |
|------------|------|-------|-------|-------|
| 906 05 002 | 18 | 7 | 7,1/8 | 2,3/4 |

**Cestino ovale in filo**

Oval basket, wire

Corbeille ovale

Ovalkorb Edelstahl Draht

Cesta oval

Acciaio Inox 18/10 - St. Steel 18/10

| | cm | H. cm | in | H. in |
|------------|-------|-------|---------|-------|
| 906 05 015 | 25x18 | 8 | 9,7/8x7 | 3,1/8 |

**Cestino frutta tondo in filo**

Fruit basket, round, wire

Corbeille a fruits ronde en fil d'acier

Drahtobstkorb, rund

Cesta frutas redonda en hilo

Acciaio Inox 18/10 - St. Steel 18/10

| | ø cm | H. cm | ø in | H. in |
|------------|------|-------|-------|-------|
| 906 05 004 | 25 | 9 | 9,7/8 | 3,1/2 |

**Cestino ovale in filo**

Oval basket, wire

Corbeille ovale

Ovalkorb Edelstahl Draht

Cesta oval

Acciaio Inox 18/10 - St. Steel 18/10

| | cm | H. cm | in | H. in |
|------------|-------|-------|----------|-------|
| 906 05 016 | 28x21 | 9 | 11x8,1/4 | 3,1/2 |



CESTINI PANE IN COTONE

cuscino con noccioli di ciliegia, **riscaldabile**. I cestini sono confezionati in pratici cavallotti a blister su cui sono stampate tutte le informazioni, comprese quelle di utilizzo e lavaggio.

COTTON BREAD BASKET

*cushion with cherry stones, **heatable**. The bread baskets come in practical hangable packs with all the information, including use and washing instructions.*



made in Italy
made in Italy



**Cestino pane**

Bread basket
Corbeille à pain
Brotkorb
Cesta pan

Cotone - Cotton

| | cm | H. cm | in | H. in |
|--------------|-------|-------|--------------|-------|
| ■ AVARI 161B | 11x11 | 15 | 4,3/8x 4,3/8 | 5,7/8 |
| ■ AVARI 163B | 18x18 | 18 | 7,1/8x7,1/8 | 7,1/8 |

**Cestino pane**

Bread basket
Corbeille à pain
Brotkorb
Cesta pan

Cotone - Cotton

| | cm | H. cm | in | H. in |
|--------------|-------|-------|--------------|-------|
| ■ AVARI 162B | 11x11 | 15 | 4,3/8x 4,3/8 | 5,7/8 |
| ■ AVARI 164B | 18x18 | 18 | 7,1/8x7,1/8 | 7,1/8 |

**Cuscino termico con noccioli**

Thermal cushion
Coussin chauffant
Wärmekissen
Cojín térmico

Cotone - Cotton

| | cm | in |
|-----------------|-------|--------------|
| ■ 325 05 24 579 | 11x11 | 4,3/8x 4,3/8 |
| ■ 325 05 24 580 | 18x18 | 7,1/8x7,1/8 |

**Sacchetto porta pane**

Bread basket
Corbeille à pain
Brotkorb
Cesta pan

Cotone - Cotton

| | ø cm | H. cm | ø in | H. in |
|-------------|------|-------|-------|-------|
| ■ AVARI 206 | 21 | 25 | 8,1/4 | 9,7/8 |
| ■ AVARI 207 | 21 | 25 | 8,1/4 | 9,7/8 |



Cestino pane

Bread basket
Corbeille à pain
Brotkorb
Cesta pan

Cotone - Cotton

| | cm | H. cm | in | H. in |
|-------------|-------|-------|-------------|-------|
| ■ AVARI 200 | 14x14 | 8 | 5,1/2x5,1/2 | 3,1/8 |
| ■ AVARI 203 | 19x19 | 10 | 7,1/2x7,1/2 | 3,7/8 |



Cestino pane

Bread basket
Corbeille à pain
Brotkorb
Cesta pan

Cotone / Cotton

| | cm | H. cm | in | H. in |
|-------------|-------|-------|-------------|-------|
| ■ AVARI 201 | 14x14 | 8 | 5,1/2x5,1/2 | 3,1/8 |
| ■ AVARI 204 | 19x19 | 10 | 7,1/2x7,1/2 | 3,7/8 |



Cestino pane

Bread basket
Corbeille à pain
Brotkorb
Cesta pan

Juta-cotone / Juta-cotton

| | cm | H. cm | in | H. in |
|-------------|-------|-------|-------------|-------|
| ■ AVARI 202 | 14x14 | 8 | 5,1/2x5,1/2 | 3,1/8 |
| ■ AVARI 205 | 19x19 | 10 | 7,1/2x7,1/2 | 3,7/8 |



Cestino portabustine mignon

Tea/sugar bag basket, small
Corbeille à sachets de thé/sucre petite
Klein Stoffkorb, Tee und Zuckerbeutelbehälter
Cestita para bolsitas de té/ azúcar pequeña

Cotone / Cotton

| | cm | H. cm | in | H. in |
|-------------|-----|-------|-------------|-------|
| ■ AVARI 208 | 6x8 | 6 | 2,3/8x3,1/8 | 2,3/8 |
| ■ AVARI 209 | 6x8 | 6 | 2,3/8x3,1/8 | 2,3/8 |

Juta / Jute

| | | | | |
|-------------|-----|---|-------------|-------|
| ■ AVARI 210 | 6x8 | 6 | 2,3/8x3,1/8 | 2,3/8 |
|-------------|-----|---|-------------|-------|

Runner - grigio scuro

Runner, dark grey
 Chemin de table gris foncé
 Runner dunkelgrau
 Camino de mesa gris oscuro

70% Pvc - 30% Pet

| | cm | in |
|-------------|--------|-------------|
| AVARI TO 31 | 45x120 | 17,3/4x47,2 |

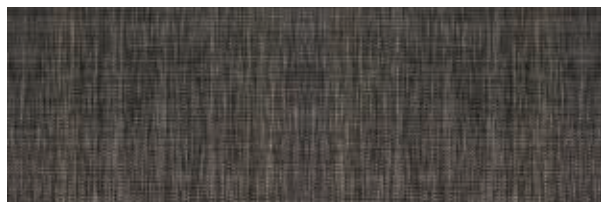
**Runner - grigio chiaro**

Runner, light grey
 Chemin de table gris clair
 Runner hellgrau
 Camino de mesa gris claro

70% Pvc - 30% Pet

| | cm | in |
|-------------|--------|-------------|
| AVARI TO 30 | 45x120 | 17,3/4x47,2 |

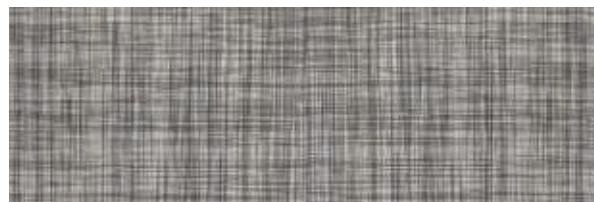
**Runner - tortora**

Runner, taupe
 Chemin de table taupe
 Runner taubegrau
 Camino de mesa gris topo

70% Pvc - 30% Pet

| | cm | in |
|-------------|--------|-------------|
| AVARI TO 32 | 45x120 | 17,3/4x47,2 |

**Runner - sabbia**

Runner, sand
 Chemin de table sable
 Runner sandgrau
 Camino de mesa arena

70% Pvc - 30% Pet

| | cm | in |
|-------------|--------|-------------|
| AVARI TO 33 | 45x120 | 17,3/4x47,2 |

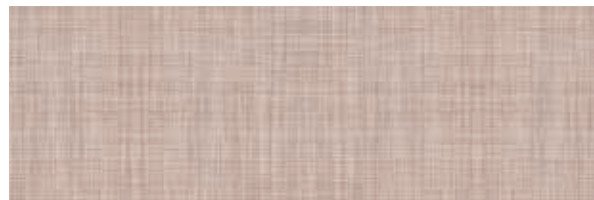
**Runner - marrone con rettangolo**

Runner, brown with rectangle
 Chemin de table marron avec rectangle
 Runner braungrau rechteckig
 Camino de mesa marrón con rectangulo

70% Pvc - 30% Pet

| | cm | in |
|-------------|--------|-------------|
| AVARI TO 34 | 45x120 | 17,3/4x47,2 |



Tovaglietta bamboo marrone chiaro

Placemat, bamboo light brown
 Nappe individuelle bamboo marron clair
 Mantel individual bambú marrón claro
 Tischset bambus, hellbraun

Bamboo

| | cm | in |
|-------------|-------|---------------|
| AVARI TO 40 | 45x30 | 17,3/4x11,3/4 |

**Tovaglietta bamboo marrone scuro**

Placemat, bamboo dark brown
 Nappe individuelle bamboo marron foncé
 Mantel individual bambú marrón oscuro
 Tischset bambus, dunkelbraun

Bamboo

| | cm | in |
|-------------|-------|---------------|
| AVARI TO 41 | 45x30 | 17,3/4x11,3/4 |

**Tovaglietta intrecciata nera**

Placemat, woven black
 Nappe individuelle tressée noire
 Mantel individual trenzado negro
 Tischset schwarz gewebt

70% Pvc - 30% Pet

| | cm | in |
|-------------|-------|---------------|
| AVARI TO 61 | 45x30 | 17,3/4x11,3/4 |

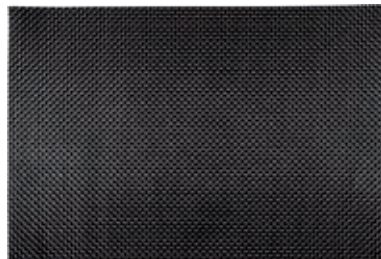
**Tovaglietta intrecciata grigia**

Placemat, woven grey
 Nappe individuelle tressée grise
 Mantel individual trenzado gris
 Tischset grau gewebt

70% Pvc - 30% Pet

| | cm | in |
|-------------|-------|---------------|
| AVARI TO 60 | 45x30 | 17,3/4x11,3/4 |

**Tovaglietta intrecciata beige**

Placemat, woven sand
 Nappe individuelle tressée beige
 Mantel individual trenzado beige
 Tischset sand gewebt

70% Pvc - 30% Pet

| | cm | in |
|-------------|-------|---------------|
| AVARI TO 63 | 45x30 | 17,3/4x11,3/4 |

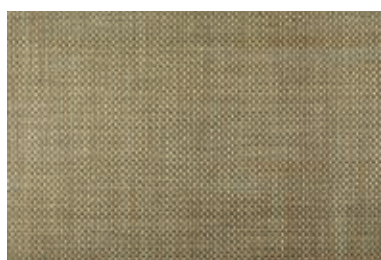
**Tovaglietta intrecciata marrone**

Placemat, woven brown
 Nappe individuelle tressée marron
 Mantel individual trenzado marrón
 Tischset braun gewebt

70% Pvc - 30% Pet

| | cm | in |
|-------------|-------|---------------|
| AVARI TO 62 | 45x30 | 17,3/4x11,3/4 |



Tovaglietta marrone con rettangolo

Placemat, brown with rectangle
 Nappe individuelle marron avec rectangle
 Mantel individual marrón con rectángulo
 Tischset braun mit Rechteck

70% Pvc - 30% Pet

| | cm | in |
|-------------------|--------------|----------------------|
| AVARITO 10 | 45x30 | 17,3/4x11,3/4 |

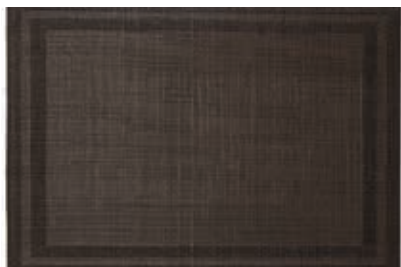
**Tovaglietta sabbia/tortora a quadri**

Placemat, sand/taupe with squares
 Nappe individuelle sable/taupe avec carrés
 Mantel individual arena/gris topo de cuadrados
 Tischset sand/Taube mit Quadraten

70% Pvc - 30% Pet

| | cm | in |
|-------------------|--------------|----------------------|
| AVARITO 11 | 45x30 | 17,3/4x11,3/4 |

**Tovaglietta riquadri**

Placemat squares
 Nappe individuelle carrés
 Klein Tischtuch mit Quadrat
 Mantel individual cuadrados

70% Pvc - 30% Pet

| | cm | in |
|--------------------|--------------|----------------------|
| AVARI TO 50 | 45x30 | 17,3/4x11,3/4 |

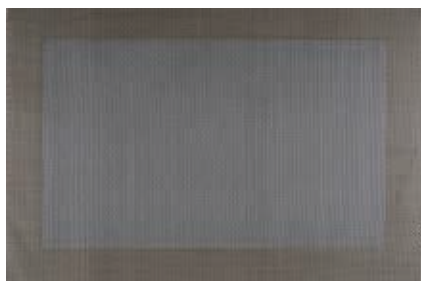
**Tovaglietta sabbia 2 fasce laterali**

Placemat, sand with 2 side stripes
 Nappe individuelle sable avec 2 bandes laterales
 Mantel individual arena con 2 bandas laterales
 Tischset sand mit 2 Seitenstreifen

70% Pvc - 30% Pet

| | cm | in |
|-------------------|--------------|----------------------|
| AVARITO 13 | 45x30 | 17,3/4x11,3/4 |

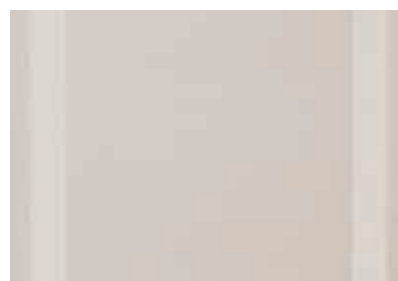
**Tovaglietta marrone 2 fasce laterali**

Placemat, brown with 2 side stripes
 Nappe individuelle marron avec 2 bandes laterales
 Mantel individual marrón con 2 bandas laterales
 Tischset braun mit 2 Seitenstreifen

70% Pvc - 30% Pet

| | cm | in |
|-------------------|--------------|----------------------|
| AVARITO 14 | 45x30 | 17,3/4x11,3/4 |



Tovaglietta - grigio scuro

Placemat - dark grey
 Nappe individuelle gris fouché
 Klein Tischtuch dunkel grau
 Mantel individual gris oscuro

70% Pvc - 30% Pet

| | cm | in |
|-------------------|--------------|----------------------|
| AVARITO 01 | 45x30 | 17,3/4x11,3/4 |

**Tovaglietta - grigio chiaro**

Placemat- light grey
 Nappe individuelle gris clair
 Klein Tischtuch hellgrau
 Mantel individual gris claro

70% Pvc - 30% Pet

| | cm | in |
|-------------------|--------------|----------------------|
| AVARITO 02 | 45x30 | 17,3/4x11,3/4 |

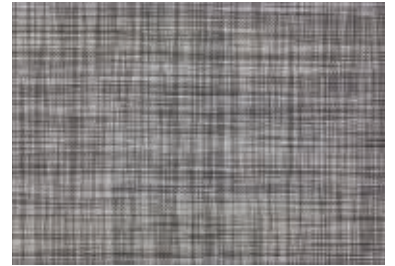
**Tovaglietta - tortora**

Placemat - taupe
 Nappe individuelle taupe
 Klein Tischtuch grau
 Mantel individual gris topo

70% Pvc - 30% Pet

| | cm | in |
|-------------------|--------------|----------------------|
| AVARITO 03 | 45x30 | 17,3/4x11,3/4 |

**Tovaglietta beige/marrone/riga azzurra**

Placemat, beige/brown/blue stripe
 Nappe individuelle beige/bleue/marron
 Klein Tischtuch beige/hellblau/braun
 Mantel individual beige/azul claro/marrón

70% Pvc - 30% Pet

| | cm | in |
|-------------------|--------------|----------------------|
| AVARITO 05 | 45x30 | 17,3/4x11,3/4 |

**Tovaglietta - sabbia**

Placemat - sand
 Nappe individuelle sable
 Klein Tischtuch sand
 Mantel individual arena

70% Pvc - 30% Pet

| | cm | in |
|-------------------|--------------|----------------------|
| AVARITO 07 | 45x30 | 17,3/4x11,3/4 |

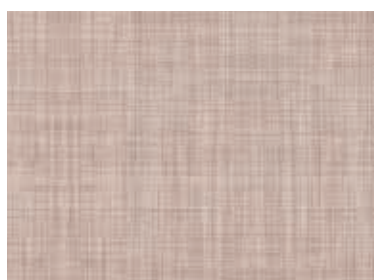

Lattiera Imperial

Imperial milkpot
Pot à lait Imperial
Milchkanne Imperial
Lechera Imperial

Acciaio Inox 18/10 - St. Steel 18/10

| | cl | oz |
|---------------|-----|----|
| V01 05 03 035 | 35 | 12 |
| V01 05 03 060 | 60 | 20 |
| V01 05 03 100 | 100 | 35 |

**Cremiera Imperial**

Imperial creamer
Crémier Imperial
Sahnekännchen Imperial
Jarrita de leche Imperial

Acciaio Inox 18/10 - St. Steel 18/10

| | cl | oz |
|---------------|----|----|
| V01 05 03 015 | 15 | 5 |

**Caffettiera Imperial**

Imperial coffee pot
Cafetière Imperial
Kaffekanne Imperial
Cafetera Imperial

Acciaio Inox 18/10 - St. Steel 18/10

| | cl | oz |
|---------------|-----|----|
| V01 05 01 035 | 35 | 12 |
| V01 05 01 060 | 60 | 20 |
| V01 05 01 100 | 100 | 35 |
| V01 05 01 150 | 150 | 51 |
| V01 05 01 200 | 200 | 68 |

**Teiera Imperial**

Imperial teapot
Théière Imperial
Teekanne Imperial
Tetera Imperial

Acciaio Inox 18/10 - St. Steel 18/10

| | cl | oz |
|---------------|-----|----|
| V01 05 02 035 | 35 | 12 |
| V01 05 02 060 | 60 | 20 |
| V01 05 02 100 | 100 | 35 |
| V01 05 02 130 | 130 | 44 |



Zuccheriera Imperial

Imperial sugar pot
 Sucrier Imperial
 Zuckerdose Imperial
 Azucarero Imperial

Acciaio Inox 18/10 - St. Steel 18/10

| | gr | oz |
|---------------|-----|----|
| V01 05 04 200 | 200 | 7 |

**Zuccheriera con maniglie Imperial**

Imperial sugar pot with lid and handles
 Sucrier avec couvercle et poignées Imperial
 Zuckerdose mit Griffen und Deckel Imperial
 Azucarero con tapa y asas Imperial

Acciaio Inox 18/10 - St. Steel 18/10

| | gr | oz |
|---------------|-----|----|
| V01 05 04 280 | 280 | 10 |

**Brocca acqua Imperial**

Imperial water pitcher
 Carafe à eau Imperial
 Wasserkrug Imperial
 Jarra agua Imperial

Acciaio Inox 18/10 - St. Steel 18/10

| | cl | oz |
|---------------|-----|----|
| V01 05 08 200 | 200 | 68 |

**Caraffa termica Imperial**

Imperial thermal beverage server
 Carafe thermos Imperial
 Thermoskanne Imperial
 Jarra térmica Imperial

Acciaio Inox 18/10 - St. Steel 18/10

| | cl | oz |
|---------------|-----|----|
| V01 05 08 T06 | 75 | 25 |
| V01 05 08 T10 | 100 | 35 |
| V01 05 08 T15 | 150 | 51 |
| V01 05 08 T20 | 200 | 68 |



Caffettiera Daily

Daily coffee pot
 Cafetière Daily
 Daily Kaffekanne
 Cafetera Daily

Acciaio inossidabile - St. Steel

| | tazze/cup | cl |
|-------------|-----------|-----|
| 906 05 044 | 2 | 15 |
| 906 05 045 | 4 | 30 |
| 906 05 045X | 5 | 45 |
| 906 05 046 | 6 | 65 |
| 906 05 047 | 9 | 110 |

**Lattiera Daily**

Daily milkpot
 Pot à lait Daily
 Daily Milchkanne
 Lechera Daily

Acciaio inossidabile - St. Steel

| | tazze/cup | cl |
|-------------|-----------|-----|
| 906 05 048 | 2 | 15 |
| 906 05 049 | 4 | 30 |
| 906 05 049X | 5 | 45 |
| 906 05 050 | 6 | 65 |
| 906 05 051 | 9 | 110 |

**Zuccheriera Daily**

Daily sugar pot
 Sucrier Daily
 Daily Zuckerdose
 Azucarero Daily

Acciaio inossidabile - St. Steel

| | gr |
|------------|-----|
| 906 05 064 | 200 |



Portacannucce

Straw holder
Porte-pailles
Trinkhalmbehälter
Portapajitas

Acciaio Inox 18/10 - St. Steel 18/10

| | ø cm | ø in | H. cm | H. in |
|---------------|------|-------|-------|-------|
| V01 05 71 011 | 9 | 3,1/2 | 11 | 4,3/8 |

**Portacucchiaini**

Tea spoon holder
Porte-cuillères à café
Kaffeelöffelbecher
Portacucharas café

Acciaio Inox 18/10 - St. Steel 18/10

| | ø cm | ø in | H. cm | H. in |
|---------------|------|-------|-------|-------|
| V01 05 71 008 | 9 | 3,1/2 | 8 | 3,1/8 |

**Portabustine zucchero/the**

Rectangular sugar tray
Sucrier rectangulaire
Zucker-Behälter
Azucarero rectangular

Acciaio Inox 18/10 - St. Steel 18/10

| | cm | in | H. cm | H. in |
|---------------|--------|----|-------|-------|
| V78 05 04 PBU | 10x6,5 | 4 | 3,5 | 1,3/8 |

**Passatè (colino tè) con coppetta**

Tea strainer
Passoire à the
Teesieb
Colador de te

Acciaio Inox 18/10 - St. Steel 18/10

| | cm | H. cm | in | H. in |
|---------------|-------|-------|---------|-------|
| V01 05 91 001 | 9,5x5 | 3 | 3,3/4x2 | 1,1/8 |



Portauovo

Egg cup
Coquetier
Eierbecher
Huevera

Acciaio Inox - St. Steel

| | ∅ cm | ∅ in |
|---------------|------|-------|
| V01 05 71 001 | 8,6 | 3,3/8 |

**Burriera piccola con coperchio**

Small butter dish with cover
Petit beurrier avec cloche
Klein Butterschale mit Deckel
Mantequera pequeña con tapa

Acciaio Inox 18/10 - St. Steel 18/10

| | ∅ cm | ∅ in |
|---------------|------|-------|
| V01 05 09 107 | 7 | 2,3/4 |

**Burriera con coperchio**

Butter dish with cover
Beurrier avec cloche
Butterschale mit Deckel
Mantequera con tapa

Acciaio Inox 18/10 - St. Steel 18/10

| | ∅ cm | ∅ in |
|---------------|------|------|
| V01 05 09 115 | 15 | 6 |

**Portasalatini 3 scomparti**

3-tier snack/relish dish
Porte-biscuits salés à 3 compartiments
Salzgebäckschale, 3-tlg
Entremesera 3 sectores

Acciaio Inox 18/10 - St. Steel 18/10

| | ∅ cm | ∅ in |
|---------------|------|-------|
| V01 05 41 003 | 10,5 | 4,1/8 |



Portamarmellata per 4 confezioni

4-jar jam holder

Porte-confiture pour 4 pots

Konfitürenschale, 4 tlg

Dispensador de mermelada para 4 botes

Acciaio Inox 18/10 - St. Steel 18/10

| | cm | in |
|---------------|-------|-------------|
| V76 05 09 001 | 18x45 | 7,1/8x1,3/4 |

**Portamarmellata 3 scomparti**

3-tier jam dish

Porte-confiture à 3 compartiments

Konfitürenschale, 3 tlg

Dispensador de mermelada 3 sectores

Acciaio Inox 18/10 - St. Steel 18/10

| | ∅ cm | H. cm | ∅ in | H. in |
|---------------|------|-------|-------|-------|
| V01 05 09 003 | 6 | 13 | 2,3/8 | 5,1/8 |

**Portamarmellata 6 scomparti**

6-tier jam dish

Porte-confiture à 6 compartiments

Konfitürenschale, 6 tlg

Dispensador de mermelada 6 sectores

Acciaio Inox 18/10 - St. Steel 18/10

| | ∅ cm | H. cm | ∅ in | H. in |
|---------------|------|-------|-------|-------|
| V01 05 09 006 | 6 | 17,5 | 2,3/8 | 6,7 |



Sottopiatto bordo inglese

Show plate with English decoration

Plat à présentation avec décoration anglaise

Platzteller mit englischer Dekoration

Plato de presentación con borde inglés

Acciaio Inox 18/10 - St. Steel 18/10

| | ø cm | ø in | ø interno cm | ø interno in |
|---------------|------|--------|--------------|--------------|
| V01 05 25 132 | 31,5 | 12,3/8 | 19,5 | 7,5/8 |

**Sottopiatto liscio**

Show plate, plain

Plat à présentation simple

Platzteller

Plato de presentación liso

Acciaio Inox 18/10 - St. Steel 18/10

| | ø cm | ø in | ø interno cm | ø interno in |
|---------------|------|--------|--------------|--------------|
| V01 05 25 032 | 31 | 12,1/4 | 20 | 7,1/4 |

**Sottobottiglia**

Bottle coaster

Sous bouteille

Flaschenuntersatz

Posabotella

Acciaio Inox 18/10 - St. Steel 18/10

| | ø cm | ø in |
|---------------|------|-------|
| V01 05 21 014 | 14 | 5,1/2 |

**Sottobicchiere**

Glass coaster

Sous verre

Untersatz

Posavasos

Acciaio Inox 18/10 - St. Steel 18/10

| | ø cm | ø in |
|---------------|------|-------|
| V01 05 21 011 | 11 | 4,3/8 |



**Anello adattatore**

Adjusting ring
Bague de réglage
Einsatzring
Anillo adaptador

Acciaio Inox 18/10 - St. Steel 18/10

| | cm | in |
|---------------|-------|-------|
| 305 05 43 540 | 10,5 | 4,1/8 |
| V01 05 43 540 | 13 cm | 5,1/8 |

**Coppetta interna**

Supreme inside cup
Coupe intérieure
Schale
Copita interior

Acciaio Inox 18/10 - St. Steel 18/10

| | cm | in |
|---------------|------|-------|
| V01 05 43 562 | 10,5 | 4,1/8 |

**Piattino portaburro**

Butter dish
Plat à beurre
Butterschale
Platito mantequilla

Acciaio Inox 18/10 - St. Steel 18/10

| | ø cm | ø in |
|---------------|------|-------|
| V01 05 43 648 | 13 | 5,1/8 |

**Griglia portaburro**

Butter grid
Grille porte-beurre
Buttergitter
Parrilla mantequilla

Acciaio Inox 18/10 - St. Steel 18/10

| | ø cm | ø in |
|---------------|------|-------|
| V01 05 43 539 | 13 | 5,1/8 |

**Coppa esterna base**

Supreme outside base cup
Coupe base extérieure Supreme
Schale auf Fuß
Copa exterior base Supreme

Acciaio Inox 18/10 - St. Steel 18/10

| | ø cm | ø in |
|---------------|------|-------|
| V01 05 43 130 | 13 | 5,1/8 |

**Coppa Supreme completa**

Supreme cup
Coupe Supreme
Hummer-/Cocktailschale
Copa Supreme, completa

Acciaio Inox 18/10 - St. Steel 18/10

| | ø cm | H. cm | ø in | H. in |
|--------------------|------|-------|-------|-------|
| V01 05 43 C13N | 13 | 8,5 | 5,1/8 | 3,3/8 |
| 3 Pezzi - 3 Pieces | | | | |



Coppa macedonia Imperial

Fruit salad cup
Coupe à dessert
Obstsalatschale
Copa macedonia

Acciaio Inox 18/10 - St. Steel 18/10

| | ø cm | ø in | H. cm | H. in |
|---------------|------|------|-------|-------|
| V01 05 43 125 | 12,5 | 5 | 5,5 | 2 |

**Coppa gelato Imperial**

Imperial ice cream cup
Coupe à glace Imperial
Eisschale Imperial
Copa helado Imperial

Acciaio Inox 18/10 - St. Steel 18/10

| | ø cm | ø in | H. cm | H. in |
|---------------|------|-------|-------|-------|
| V01 05 43 010 | 9,5 | 3,3/4 | 10 | 4 |

**Piattino sottocoppa**

Cup saucer
Plat sous coupe
Untersatz
Platito posacopa

Acciaio Inox 18/10 - St. Steel 18/10

| | ø cm | ø in |
|---------------|------|-------|
| V01 05 21 013 | 13 | 5,1/8 |

**Portafiori**

Flower vase
Vase à fleurs
Blumenvase
Florero

Acciaio Inox 18/10 - St. Steel 18/10

| | H. cm | H. in |
|---------------|-------|-------|
| V01 05 19 015 | 16,5 | 6,1/2 |



Vassoio multiuso

Multipurpose tray
 Plateau universelle
 Universale Platte
 Bandeja universal

Acciaio Inox 18/10 - St. Steel 18/10

| | cm | in |
|---------|--------|-------------|
| CI 3005 | 24x9,5 | 9,1/2x3,3/4 |

**Salsiera con piattino**

Sauce boat with underliner
 Saucière avec soucoupe
 Soßenschüssel mit Tellerchen
 Salsiera con platito

Acciaio Inox 18/10 - St. Steel 18/10

| | cl | oz |
|---------------|----|----|
| V61 05 12 030 | 30 | 10 |

**Salsiera**

Sauce boat
 Saucière
 Soßenschüssel
 Salsiera

Acciaio Inox 18/10 - St. Steel 18/10

| | cl | oz |
|----------|----|----|
| CI 25401 | 10 | 3 |
| CI 25402 | 20 | 7 |
| CI 25403 | 30 | 10 |

**Cloche**

Dome cover
 Cloche
 Speiseglocke
 Campana

Acciaio Inox 18/10 - St. Steel 18/10

| | ø cm | ø in |
|---------------|------|--------|
| V01 05 53 024 | 24 | 9,1/2 |
| V01 05 53 026 | 26 | 10,1/4 |
| V01 05 53 028 | 28 | 11 |
| V01 05 53 030 | 30 | 11,3/4 |



Portatovaglioli Imperial

Imperial napkin holder
 Porte-serviette Imperial
 Serviettenhalter Imperial
 Servilletero Imperia

Acciaio Inox 18/10 - St. Steel 18/10

| | cm | H. cm | in | H. in |
|---------------|------|-------|-------|-------|
| V01 05 71 105 | 10,5 | 9 | 4,1/8 | 3,1/2 |



Portatovaglioli Square

Square napkin holder
 Porte-serviettes Square
 Serviettenhalter Square
 Servilletero Square

Acciaio Inox 18/10 - St. Steel 18/10

| | cm | H. cm | in | H. in |
|---------------|------|-------|-------------|-------|
| V76 05 71 001 | 11x4 | 8 | 4,3/8x1,2/3 | 3,1/8 |



Portatovaglioli quadrato

Napkin holder, square
 Porte-serviette carré
 Viereckiger Serviettenhalter
 Servilletero cuadrado

Acciaio Inox 18/10 - St. Steel 18/10

| | cm | H. cm | in | H. in |
|---------------|-------|-------|-------------|-------|
| V01 05 71 190 | 19x19 | 7 | 7,1/2x7,1/2 | 2,3/4 |

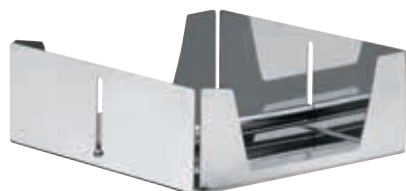

Porta kleenex

Kleenex holder
 Porte-kleenex
 Taschentücherhalter
 Porta kleenex

Acciaio Inox 18/10 - St. Steel 18/10

| | cm | H. cm | in | H. in |
|---------------|-------|-------|-------------|-------|
| V01 05 71 002 | 22x12 | 5,5 | 8,5/8x4,3/4 | 2,1/8 |



Lavadita

Finger bowl
 Rince-doigts
 Fingerschale
 Lavadedos

Acciaio Inox 18/10 - St. Steel 18/10

| | ø cm | ø in |
|---------------|------|-------|
| V01 05 43 012 | 12 | 4,3/4 |



Portatovaglioli da banco verticale

Vertical napkin holder
 Porte-serviettes vertical
 Vertikaler Thekenserviettenhalter
 Servilletero cuadrado vertical

Acciaio Inox 18/10 - St. Steel 18/10

| | cm | H. cm | in | H. in |
|------------|--------|-------|-------------|-------|
| 906 05 008 | 8,5x11 | 16 | 3,3/8x4,3/8 | 6,1/4 |



Coperchio legumiera/zuppiera

Cover for vegetable dish/soup tureen

Couvercle pour soupière/légumier

Deckel für Suppen-Gemüseschüssel

Tapa legumbrera/sopera

Acciaio Inox 18/10 - St. Steel 18/10

| | ø cm | ø in |
|---------------|------|--------|
| V01 05 15 C14 | 14 | 5,1/2 |
| V01 05 15 C18 | 18 | 7,1/8 |
| V01 05 15 C22 | 22 | 8,5/8 |
| V01 05 15 C24 | 24 | 9,1/2 |
| V01 05 15 C26 | 26 | 10,1/4 |
| V01 05 15 C28 | 28 | 11 |
| V01 05 15 C30 | 30 | 11,3/4 |

**Zuppiera**

Soup tureen

Soupière

Suppenschüssel

Sopera

Acciaio Inox 18/10 - St. Steel 18/10

| | ø cm | ø in | lt | oz |
|---------------|------|--------|------|-----|
| V01 05 15 Z14 | 14 | 5,1/2 | 0,75 | 25 |
| V01 05 15 Z18 | 18 | 7,1/8 | 1,5 | 50 |
| V01 05 15 Z22 | 22 | 8,5/8 | 2,5 | 85 |
| V01 05 15 Z24 | 24 | 9,1/2 | 3,5 | 118 |
| V01 05 15 Z26 | 26 | 10,1/4 | 4,25 | 144 |
| V01 05 15 Z28 | 28 | 11 | 5,25 | 178 |
| V01 05 15 Z30 | 30 | 11,3/4 | 6,5 | 220 |

**Legumiera**

Vegetable dish

Légumier

Gemüseschüssel

Legumbrera

Acciaio Inox 18/10 - St. Steel 18/10

| | ø cm | ø in | lt | oz |
|---------------|------|--------|-----|-------|
| V01 05 15 L14 | 14 | 5,1/2 | 0,8 | 27 |
| V01 05 15 L18 | 18 | 7,1/8 | 1,4 | 47 |
| V01 05 15 L22 | 22 | 8,5/8 | 1,9 | 64 |
| V01 05 15 L24 | 24 | 9,1/2 | 2,8 | 94,6 |
| V01 05 15 L26 | 26 | 10,1/4 | 3,8 | 128,5 |
| V01 05 15 L28 | 28 | 11 | 4,8 | 162 |



Segnatavolo a colonna (portanumero)

Table number stand, column-shaped

Support numéro de table à colonne

Tischnummerständer

Número sobremesa a columna

Acciaio Inox 18/10 - St. Steel 18/10

| | H. cm | H. in |
|---------------|-------|--------|
| V01 05 19 019 | 19 | 7,1/2 |
| V01 05 19 046 | 45 | 17,3/4 |

**Cavalletto portaetichetta per buffet (senza tavoletta - without black tag)**

Buffet easel for tags

Chevalet porte-nom pour buffet

Aufsteller Produktinfo

Soporte caballete para etiqueta para buffet

Inox 18/10 - St. Steel

| | H. cm | H. in |
|---------------|-------|-------|
| V01 05 19 001 | 14,5 | 5,3/4 |

Tavoletta nera per cavalletto

Black tag for easel

Plaque pour chevalet noir

Schild für Produktinfo

Etiqueta negra para soporte caballete

Plexiglass

| | H. cm | H. in |
|---------------|--------|-------|
| V01 12 19 001 | 10x7,5 | 4x3 |

**Portatoast in filo**

Toast holder, steel wire

Porte-toasts en fil

Toastständer

Portatostadas en hilo

Acciaio Inox 18/10 - St. Steel 18/10

| | cm | H. cm | in | H. in |
|---------------|------|-------|-------|-------|
| V01 05 71 195 | 19,5 | 15 | 7,5/8 | 6 |



Formaggiara Imperial

Imperial grated-cheese holder
 Ravier à parmesan Imperial
 Käsedose Imperial
 Quesera Imperial

Acciaio Inox 18/10 - St. Steel 18/10

| | cm | H. cm | in | H. in |
|---------------|-----------|-------|-------------|-------|
| V01 05 13 001 | 15,5x12,5 | 8 | 6,1/8x4,7/8 | 3,1/8 |

**Oliera 4 pezzi Imperial**

Imperial oil & vinegar cruet set, 4-piece
 Ménagère Imperial, 4 pièces
 Menage, 4-tlg Imperial
 Servicio de mesa Imperial, 4 piezas

Acciaio Inox 18/10 - St. Steel 18/10

| | cm | H. cm | in | H. in |
|---------------|-----------|-------|-------------|-------|
| V01 05 11 005 | 16,5x13,5 | 23 | 6,1/2x5,3/8 | 9 |

**Oliera 2 pezzi Imperial**

Imperial oil & vinegar cruet set, 2-piece
 Ménagère Imperial, 2 pièces
 Menage, 2-tlg Imperial
 Servicio de mesa Imperial, 2 piezas

Acciaio Inox 18/10 - St. Steel 18/10

| | cm | H. cm | in | H. in |
|---------------|---------|-------|-------------|-------|
| V01 05 11 002 | 14,5x10 | 23 | 5,3/4x3,7/8 | 9 |

**Spargi sale/pepe singolo Imperial**

Imperial salt/pepper shaker
 Salière/poivrière individuelle Imperial
 Salz/Pfefferstreuer Imperial
 Salero/pimentero individual Imperial

Acciaio Inox 18/10 - St. Steel 18/10

| | Ø cm | H. cm | Ø in | H. in |
|---------------|------|-------|-------|-------|
| V01 05 12 001 | 3,5 | 9 | 1,3/8 | 3,1/2 |



Formaggiere 2000

2000 cheese bowl

Fromagère 2000

Käsedose 2000

Quesera 2000

Acciaio Inox 18/10 - St. Steel 18/10

| | cm | H. cm | in | H. in |
|---------------|------|-------|-------------|-------|
| V61 05 13 001 | 13x9 | 7,5 | 5,1/8x3,1/2 | 3 |

**Oliera 5 pezzi Menage**

Menage oil & vinegar cruet set, 5-piece

Ménagère Menage, 5 pièces

Menage, 5-tlg

Servicio de mesa Menage, 5 piezas

Acciaio Inox - St. Steel

| | cm | H. cm | in | H. in |
|---------------|---------|-------|--------------|-------|
| V12 06 11 005 | 15x11,5 | 22 | 5,7/8x 4,1/2 | 8,5/8 |

**Tris sale, pepe e stecchi Inox**

Salt and pepper shakers and toothpick holder, plain

Salière, poivrière et porte cure-dents simples

Salz/Pfefferstreuer mit Zahnstochträger, Edelstahl

Tris salero, pimentero y palillero Inox

Acciaio Inox - St. Steel

| | cm | H. cm | in | H. in |
|---------------|---------|-------|---------|-------|
| V12 06 12 003 | 8,5x7,5 | 14,5 | 3,3/8x3 | 5,3/4 |

**Cestino porta salse 4 Pezzi**

Sauce-jar holder, 4-pc

Porte-sauces 4 pcs

Soßenkorb 4pz

Porta salsas 4 pzs

Acciaio Inox 18/10 - St. Steel 18/10

| | ø cm | H. cm | ø in | H. in |
|----------|------|-------|-------|-------|
| AVARI231 | 16 | 25 | 6,1/4 | 9,7/8 |



Sale/pepe Square

Glass cruet salt spreader Square

Verre pour salière Square

Salzstreuer mit

Vidrio salero Square

Acciaio Inox - St. Steel

| | cm | in | H. cm | H. in |
|---------------|---------|-------------|-------|-------|
| V76 05 12 002 | 9,5x4,5 | 3,3/4x1,3/4 | 12,5 | 5 |

**Oliera 2 pz olio/aceto Square**

Glass cruet oil/vinegar set Square

Burette huile/vinaigre Square

Essig/Ölglas flaschen mit

Alcuza aceite/vinagre Square

Acciaio Inox - St. Steel

| | cm | in | H. cm | H. in |
|---------------|----------|---------|-------|-------|
| V76 05 11 002 | 12,5x5,5 | 5x2,1/8 | 20 | 7,7/8 |

**Formaggiera Square**

Cheese bowl Square

Ravier a parmesan Square

Käsedose Square

Quesera Square

Acciaio Inox - St. Steel

| | cm | in | H. cm | H. in |
|---------------|-------|-------------|-------|-------|
| V76 05 13 001 | 8,5x9 | 3,3/8x3,1/2 | 8,5 | 3,3/8 |



Portabottiglie olio/aceto con spargisale/pepe

Oil and vinegar bottle rack with salt and pepper shakers

Porte bouteilles huile-vinaigre, salière, poivrière

Essig/Ölflaschenträger, Salz/Pfeffersteuer

Portabotellas aceite y vinagre, salero, pimentero

Acciaio Inox - St. Steel

| | cl | oz | cm |
|-------------|----|------|-----------|
| AVARI 060 A | 25 | 9 | 12x5,5x25 |
| AVARI 061 A | 50 | 17,5 | 14x7x81 |

**Portabottiglie olio/aceto**

Oil and vinegar bottle rack

Porte bouteilles huile-vinaigre

Essig/Ölflaschenträger

Portabotellas aceite y vinagre

Acciaio Inox - St. Steel

| | cl | oz | cm |
|-----------|----|------|-------------|
| AVARI 060 | 25 | 9 | 12x6,5x25 |
| AVARI 061 | 50 | 17,5 | 14,5x7,5x32 |

**Oliera**

Oil dispenser

Huilière

Ölbehälter

Aceitera grande

Acciaio Inox - St. Steel

| | lt | oz |
|-----------|-----|------|
| AVARI 071 | 0,5 | 17,5 |
| AVARI 072 | 1,0 | 35 |

**Macinapepe e spargisale**

Pepper/salt mill

Moulin à poivre/sel

Pfeffermühle/Salzmühle

Molinillo pimienta/sal

Acrilico + Ceramica + Al / Acrylic + Ceramic + Aluminum

| | cm | H. cm | in | H. in |
|-----------|-----|-------|-------------|-------|
| AVARI075A | 4x4 | 9 | 1,5/8x1,5/8 | 3,1/2 |
| AVARI075B | 4x4 | 12 | 1,5/8x1,5/8 | 4,3/4 |



Oliera Pasha

Pasha oil & vinegar cruet set
 Ménagère Pasha
 Menage Pasha
 Servicio de mesa Pasha

PP

- V02 12 11 004 07
- V02 12 11 004 13
- V02 12 11 004 47

**Formaggiera Pasha con vaso vetro**

Pasha grated-cheese holder
 Ravier à parmesan Pasha
 Käsedose Pasha
 Quesera Pasha

PP

- V02 12 13 001 07
- V02 12 13 001 13
- V02 12 13 001 47

**Oliera Jolly**

Jolly oil & vinegar cruet set
 Ménagère Jolly
 Menage Jolly
 Servicio de mesa Jolly

PP

- V10 12 11 004 38
- V10 12 11 004 40
- V10 12 11 004 47

**Formaggiera Jolly**

Jolly grated-cheese holder
 Ravier à parmesan Jolly
 Käsedose Jolly
 Quesera Jolly

PP + PS

- V10 12 13 001 38
- V10 12 13 001 40
- V10 12 13 001 47



Vassoio tondo bar

Round bar tray
 Plateau rond bar
 Austellplatte, rund
 Bandeja redonda bar

Acciaio Inox 18/10 - St. Steel 18/10

| | ∅ cm | ∅ in |
|---------------|------|--------|
| V01 05 23 T32 | 32 | 12,5/8 |
| V01 05 23 T38 | 38 | 15 |
| V01 05 23 T46 | 46 | 18,1/8 |
| V01 05 23 T54 | 54 | 21,1/4 |



Vassoio tondo bar con maniglie

Round bar tray with handles
 Plateau rond bar avec poignées
 Austellplatte mit Griffen, rund
 Bandeja redonda bar con asas

Acciaio Inox 18/10 - St. Steel 18/10

| | ∅ cm | ∅ in |
|----------------|------|--------|
| V01 05 23 T32M | 32 | 12,5/8 |
| V01 05 23 T38M | 38 | 15 |
| V01 05 23 T46M | 46 | 18,1/8 |
| V01 05 23 T54M | 54 | 21,1/4 |



Vassoio tondo con bordo Basic

Basic round tray
 Plateau rond Basic
 Austellplatte, rund Basic
 Bandeja redonda Basic

Acciaio Inox 18/10 - St. Steel 18/10

| | ∅ cm est. | ∅ cm int. | ∅ in ext. | ∅ in int. |
|----------------|-----------|-----------|-----------|-----------|
| V01 05 23 TB31 | 31 | 27 | 12,1/4 | 10,5/8 |
| V01 05 23 TB36 | 36 | 30 | 14,1/8 | 11,3/4 |
| V01 05 23 TB41 | 41 | 35 | 16,1/8 | 13,3/4 |



Vassoio birra

Beer tray
 Plateau à bière
 Bierplatte
 Bandeja para cerveza

Acciaio Inox 18/10 - St. Steel 18/10

| | ∅ cm | ∅ in |
|---------|------|--------|
| CI 5412 | 40 | 15,3/4 |



Vassoio rettangolare gastronorm

Gastronorm tray, rectangular
 Plateau rectangulaire Gastronorm
 Austellplatte, rechteckig, Gastronorm
 Bandeja rectangular Gastronorm

Acciaio Inox 18/10 - St. Steel 18/10

| | cm | in |
|---------------|-----------|---------------|
| V01 05 23 G12 | 26,5x32,5 | 10,3/8x12,3/4 |
| V01 05 23 G11 | 53x32,5 | 20,7/8x12,3/4 |
| V01 05 23 G21 | 65x53 | 25,5/8x20,7/8 |

**Vassoio rettangolare gastronorm con maniglie**

Gastronorm tray with handles, rectangular
 Plateau rectangulaire Gastronorm avec poignées
 Austellplatte mit Griffen, rechteckig, Gastronorm
 Bandeja rectangular Gastronorm con asas

Acciaio Inox 18/10 - St. Steel 18/10

| | cm | in |
|----------------|-----------|---------------|
| V01 05 23 G12M | 32,5x26,5 | 12,3/4x10,3/8 |
| V01 05 23 G11M | 53x32,5 | 20,7/8x12,3/4 |
| V01 05 23 G21M | 65x53 | 25,5/8x20,7/8 |

**Vassoio rettangolare Basic**

Gastronorm tray, rectangular
 Plateau rectangulaire Gastronorm
 Austellplatte, rechteckig, Gastronorm
 Bandeja rectangular Gastronorm

Acciaio Inox 18/10 - St. Steel 18/10

| | cm | in |
|----------------|-----------|---------------|
| V01 05 23 GB12 | 26,5x32,5 | 10,3/8x12,3/4 |
| V01 05 23 GB11 | 53x32,5 | 20,7/8x12,3/4 |
| V01 05 23 GB21 | 65x53 | 25,5/8x20,7/8 |

**Vassoio sovrapponibile gastronorm rettangolare (1 pz - 1 pc)**

Stackable gastronorm rectangular tray
 Plateau empilable gastronorme rectangulaire avec poignées
 Gastronorm Tablett - rund und stapelbar
 Bandeja rectangular gastronorm apilable

Acciaio Inox 18/10 - St. Steel 18/10

| | cm | in |
|----------------|---------|---------------|
| V01 05 23 G11S | 53x32,5 | 20,7/8x12,3/4 |
| V01 05 23 G21S | 65x53 | 25,5/8x20,7/8 |



Vassoio rettangolare bar con bordo

Bar tray with edge, rectangular
 Plateau rectangulaire bar avec rebord
 Austellplatte, rechteckig
 Bandeja rectangular bar con borde

Acciaio Inox 18/10 - St. Steel 18/10

| | cm | in |
|---------------|-------|---------------|
| V01 05 23 R30 | 30x24 | 11,3/4x9,1/2 |
| V01 05 23 R35 | 35x29 | 13,3/4x11,1/2 |
| V01 05 23 R40 | 40x31 | 15,3/4x12,1/4 |
| V01 05 23 R45 | 45x34 | 17,3/4x13,3/8 |
| V01 05 23 R52 | 52x40 | 20,1/2x15,3/4 |
| V01 05 23 R62 | 62x48 | 24,3/8x19 |



Vassoio rettangolare bar senza bordo

Bar tray without edge, rectangular
 Plateau rectangulaire bar sans rebord
 Austellplatte rechteckig
 Bandeja rectangular bar sin borde

Acciaio Inox 18/10 - St. Steel 18/10

| | cm | in |
|---------------|-------|---------------|
| V03 05 23 R27 | 27x21 | 10,5/8x8,1/4 |
| V03 05 23 R30 | 30x24 | 11,3/4x9,1/2 |
| V03 05 23 R35 | 35x28 | 13,3/4x11 |
| V03 05 23 R40 | 40x32 | 15,3/4x12,5/8 |
| V03 05 23 R45 | 45x35 | 17,3/4x13,3/4 |
| V03 05 23 R50 | 50x38 | 19,3/4x15 |
| V01 05 23 R65 | 65x45 | 25,5/8x17,3/4 |



Vassoio rettangolare bar senza bordo

Bar tray without edge, rectangular
 Plateau rectangulaire bar sans rebord
 Austellplatte rechteckig
 Bandeja rectangular bar sin borde

Acciaio Inox - St. Steel

| | cm | in |
|---------------|-------|---------------|
| V03 06 23 R27 | 27x21 | 10,5/8x8,1/4 |
| V03 06 23 R31 | 30x24 | 11,3/4x9,1/2 |
| V03 06 23 R36 | 35x28 | 13,3/4x11 |
| V03 06 23 R40 | 40x32 | 15,3/4x12,5/8 |
| V03 06 23 R45 | 45x35 | 17,3/4x13,3/4 |
| V03 06 23 R50 | 50x38 | 19,3/4x15 |



Piatto portata ovale con bordo/pes

Oval platter with rim
 Plateau oval bordé
 Fuente oval con borde
 Bratenplatte, oval

Acciaio inox 18/10 - St. steel 18/10

| | cm | in |
|---------------|-------|---------------|
| V01 05 22 029 | 30x21 | 11,3/4x8,1/4 |
| V01 05 22 034 | 35x24 | 13,3/4x9,1/2 |
| V01 05 22 038 | 40x27 | 15,3/4x10,5/8 |
| V01 05 22 044 | 45x33 | 17,3/4x13 |
| V01 05 22 049 | 50x33 | 19,3/4x13 |
| V01 05 22 059 | 59x40 | 23,1/4x15,3/4 |



Piatto portata ovale con bordo Easy

Easy plate with edge, oval
Assiette ovale Easy avec rebord
Oval Tablett "Easy" mit Rand
Fuente oval Easy con borde

Acciaio Inox - St. Steel

| | cm | in |
|---------------|-------|---------------|
| V65 05 23 020 | 20X11 | 7,7/8x4,3/8 |
| V65 05 23 025 | 25x17 | 9,7/8x6,3/4 |
| V65 05 23 030 | 30x21 | 11,3/4x8,1/4 |
| V65 05 23 035 | 35x24 | 13,3/4x9,1/2 |
| V65 05 23 040 | 40x27 | 15,3/4x10,5/8 |
| V65 05 23 045 | 45x30 | 17,3/4x11,3/4 |
| V65 05 23 050 | 50x33 | 19,3/4x13 |
| V65 05 23 059 | 59X40 | 23,1/4x15,3/4 |

**Piatto ovale senza bordo**

Plate without edge, oval
Assiette ovale sans rebord
Bratenplatte, oval
Fuente oval sin borde

Acciaio Inox 18/10 - St. Steel 18/10

| | cm | in |
|---------------|-------|---------------|
| V03 05 22 025 | 25x17 | 9,7/8x6,3/4 |
| V03 05 22 030 | 30x21 | 11,3/4x8,1/4 |
| V03 05 22 035 | 35x24 | 13,3/4x9,1/2 |
| V03 05 22 040 | 40x27 | 15,3/4x10,5/8 |
| V03 05 22 045 | 45x31 | 17,3/4x12,1/4 |
| V03 05 22 050 | 50x35 | 19,3/4x13,3/4 |

**Piatto portata tondo con bordo**

Plate with edge, round
Assiette ronde avec rebord
Bratenplatte, rund mit Rand
Fuente redonda con borde

Acciaio Inox 18/10 - St. Steel 18/10

| | ø cm est. | ø cm int. | ø in ext. | ø in int. |
|---------------|-----------|-----------|-----------|-----------|
| V01 05 22 T29 | 29 | 20 | 11,1/2 | 7,7/8 |
| V01 05 22 T38 | 38 | 26 | 15 | 10,1/4 |

**Piatto portata pesce**

Fish plate
Assiette à poisson
Fischplatte
Fuente para pescado

Acciaio Inox - St. Steel

| | cm | in |
|---------------|---------|---------------|
| V01 05 22 P60 | 60x24,5 | 23,5/8x9,5/8 |
| V01 05 22 P70 | 70x28,5 | 27,1/2x11,1/4 |



WINE
&
BAR

WINE & BAR



Secchio Cacao con manico in ecopelle

Cacao bucket with leather handle
 Seau Cacao avec manche en cuir
 Champagnekühler mit Eimer Cacao (Griff aus Leder)
 Cubo Cacao con mango de cuero

Acciaio Inox 18/10 - St. Steel 18/10 + E.P. - E.L.

| | ø cm | H. cm | ø in | H. in |
|---------------|------|-------|-------|-------|
| V36 05 20 M01 | 19 | 19,5 | 7,1/2 | 7,5/8 |

**Secchio Cacao con pomolo**

Cacao bucket with knob
 Seau Cacao avec poignée
 Champagnekühler Cacao mit Knopf
 Champañera Cacao con pomo

Acciaio inox 18/10 - St. steel 18/10

| | ø cm | H. cm | ø in | H. in |
|---------------|------|-------|-------|-------|
| V36 05 20 P01 | 19 | 19,5 | 7,1/2 | 7,5/8 |

**Supporto secchio Cacao**

Cacao champagne cooler stand
 Support pour seau à champagne Cacao
 Cacao Champagnekühler Ständer
 Soporte para champañera Cacao

Acciaio inox 18/10 - St. steel 18/10

| | cm | in |
|---------------|------|--------|
| V36 05 20 001 | 59,5 | 23,1/2 |



Glacette Modern

Modern glacette
Glacette Modern
Weinkühler Modern
Enfriador de botella

Acciaio Inox - St. Steel

| | | ∅ cm | ∅ in | H. cm | H. in |
|---------------------|------------|----------|------------|-------|-------|
| V78 05 24 01 01 401 | est int | 12 10 | 4.3/4 4 | 19,5 | 7,5/8 |

**Secchio ovale Modern**

Modern Champagne cooler
Seau à champagne ovale Modern
Modern oval Champagnekühler
Champañera oval Modern

Acciaio inox 18/10 - St. steel 18/10

| | | ∅ cm | H. cm | ∅ in | H. in |
|---------------|--|------|-------|--------|-------|
| V78 05 20 003 | | 27 | 21,5 | 10,5/8 | 8,5/1 |

● **PVD Rame - PVD Copper**

| | | ∅ cm | H. cm | ∅ in | H. in |
|---------------|--|------|-------|--------|-------|
| V78 40 20 003 | | 27 | 21,5 | 10,5/8 | 8,5/1 |

**Supporto secchio ovale Modern**

Champagne bucket stand
Support pour seau à champagne
Sektühlerständer
Soporte champañera

Acciaio inox 18/10 - St. steel 18/10

| | cm | in | ∅ cm | ∅ in |
|---------------|------|--------|------|------|
| V78 05 20 677 | 59,5 | 23,1/2 | 25,5 | 10 |

● **PVD Rame - PVD Copper**

| | cm | in | ∅ cm | ∅ in |
|---------------|------|--------|------|------|
| V78 40 20 677 | 59,5 | 23,1/2 | 25,5 | 10 |





Secchio ghiaccio Modern

Modern ice bucket
 Seau à glace Modern
 Eiswürfelbehälter Modern
 Cubo hielo Modern

Acciaio Inox - St. Steel

| | | ∅ cm | ∅ in | H. cm | H. in |
|---------------------|-----|------|-------|-------|-------|
| V78 05 20 00 11 401 | est | 15 | 6 | 17 | 6,3/4 |
| | int | 13 | 5,1/8 | | |

Secchio tondo Modern

Modern Champagne cooler
 Seau à champagne Modern
 Modern Champagnekühler
 Champañera Modern

Acciaio inox 18/10 - St. steel 18/10

| | | ∅ cm | H. cm | ∅ in | H. in |
|---------------|--|------|-------|-------|-------|
| V78 05 20 002 | | 24 | 22,5 | 9,1/2 | 8,7/8 |

● **PVD Rame - PVD Copper**

| | | ∅ cm | H. cm | ∅ in | H. in |
|---------------|--|------|-------|-------|-------|
| V78 40 20 002 | | 24 | 22,5 | 9,1/2 | 8,7/8 |

**Supporto secchio tondo Modern**

Modern champagne cooler stand
 Support pour seau à champagne Modern
 Modern Champagnekühler Ständer
 Soporte para champañera Modern

Acciaio inox 18/10 - St. steel 18/10

| | cm | in |
|---------------|----|--------|
| V78 05 20 676 | 57 | 22,1/2 |

● **PVD Rame - PVD Copper**

| | cm | in |
|---------------|----|--------|
| V78 40 20 676 | 57 | 22,1/2 |

Glacette doppio corpo Wine&Bar

Wine&Bar double wall bottle cooler
 Rafrâchisseur à bouteille/vin double paroi Wine&Bar
 Weinkühler, doppelwandig Wine&Bar
 Enfriador de botella doble pared Wine&Bar

Acciaio Inox 18/10 - St. Steel 18/10

| | ø cm | ø in | H. cm | H. in |
|---------------|------|-------|-------|-------|
| V78 05 24 014 | 13 | 5,1/8 | 21 | 8,1/4 |

**Secchio champagne per 2/3 bottiglie Wine&Bar**

Wine&Bar champagne cooler for 2/3 bottles
 Seau à champagne pour 2/3 bouteilles Wine&Ba
 2/3 Flaschen Champagnekühler Wine&Ba
 Champañera para 2/3 botellas Wine&Ba

Acciaio Inox 18/10 - St. Steel 18/10

| | ø cm | ø in | H. cm | H. in |
|---------------|------|-------|-------|-------|
| V78 05 20 022 | 22 | 8,5/8 | 21 | 8,1/4 |

**Supporto secchio spumante linea Wine&Bar**

Wine&Bar champagne cooler stand
 Support pour seau à champagne Wine&Bar
 Wine&Bar Champagnekühler Ständer
 Soporte para champañera Wine&Bar

Acciaio Inox 18/10 - St. Steel 18/10

| | ø cm | ø in | H. cm | H. in |
|---------------|------|------|-------|--------|
| V78 05 20 675 | 23 | 9 | 58 | 22,7/8 |

Shaker

Cocktail shaker
Shaker
Cocktail Shaker
Coctelera

Acciaio Inox 18/10 - St. Steel 18/10

| | lt | oz |
|---------------|-----|----|
| V78 05 81 SHA | 0,7 | 17 |

● **PVD Rame - PVD Copper**

| | lt | oz |
|---------------|-----|----|
| V78 40 81 SHA | 0,7 | 17 |

**Bicchieri Boston**

Boston mixing container
Verre en métal pour Boston
Boston Metallbecher
Vaso en metal para Boston

Acciaio Inox 18/10 - St. Steel 18/10**Vetro - Glass**

| | lt | ø cm | ø in | |
|------------------|-----|------|------|---------------|
| V78 05 81 SHA 2B | 0,7 | 9 | 17 | 6,3/4 acciaio |
| V78 08 81 SHA 2B | 0,7 | 9 | 17 | 6,3/4 vetro |

● **PVD Rame - PVD Copper**

| | lt | ø cm | ø in | |
|------------------|-----|------|------|------------|
| V78 40 81 SHA 2B | 0,7 | 9 | 17 | 6,3/4 rame |

Secchiello ghiaccio doppio corpo

Double wall ice bucket
Seau à glace double paroi
Eiswürfelbehälter, doppelwandig
Cubo hielo doble pared

Acciaio Inox 18/10 - St. Steel 18/10

| | ø cm | ø in | H. cm | H. in |
|---------------|------|-------|-------|-------|
| V78 05 20 014 | 13 | 5,1/8 | 18 | 7,1/8 |

**Versavino**

Red wine holder
Porte-bouteille
Portabotella
Rotweinwiege

Acciaio Inox 18/10 - St. Steel 18/10

| | cm | in |
|---------------|----|--------|
| V01 05 24 022 | 30 | 11,3/4 |

**Scoladecanter**

Decanter wine stand
Egouttoir de carafe
Karaffentrockner
Soporte para decantador

Acciaio Inox - St. Steel

| | H. cm | H. in |
|---------------|-------|--------|
| V01 05 24 020 | 30 | 11,3/4 |

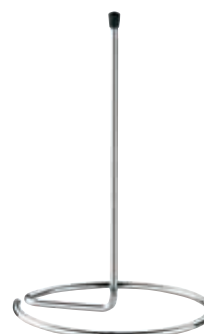



Secchio ghiaccio Imperial

Imperial ice bucket

Seau à glace Imperial

Imperial Eiswürfelbehälter

Cubo hielo Imperial

Acciaio Inox 18/10 - St. Steel 18/10

| | ø cm | ø in | H. cm | H. in |
|---------------|------|-------|-------|-------|
| V01 05 20 013 | 13,5 | 5,3/8 | 13 | 5,1/8 |

**Secchio champagne Imperial**

Imperial champagne cooler

Seau à champagne Imperial

Imperial Champagnekühler

Champañera Imperial

Acciaio Inox - St. Steel

| | ø cm | ø in | H. cm | H. in |
|---------------|------|-------|-------|-------|
| V01 05 20 020 | 21 | 8,1/4 | 20 | 7,7/8 |

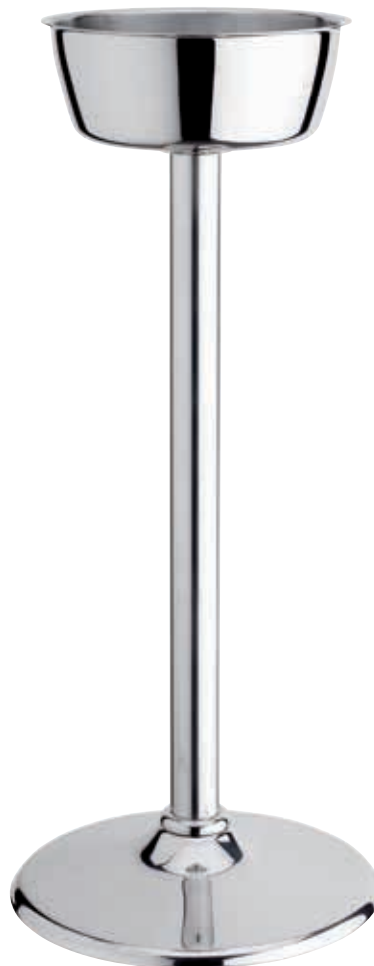
**Supporto secchio Imperial**

Imperial champagne cooler stand

Support pour seau à champagne Imperial

Imperial Champagnekühler Ständer

Soporte para champañera Imperial

Acciaio Inox 18/10 - St. Steel 18/10

| | ø cm | ø in | H. cm | H. in |
|---------------|------|-------|-------|-------|
| V01 05 20 675 | 21 | 8,1/4 | 61 | 24 |

Secchio ghiaccio Basic

Basic ice bucket
 Seau à glace Basic
 Eiskühler Basic
 Cubo hielo Basic

Acciaio Inox - St. Steel

| | ø cm | ø in | H. cm | H. in |
|------------|------|-------|-------|-------|
| 906 05 012 | 13 | 5,1/8 | 13 | 5,1/8 |

**Secchio champagne Basic**

Basic champagne bucket
 Seau à champagne Basic
 Sektkühler Basic
 Champañera Basic

Acciaio Inox - St. Steel

| | ø cm | ø in | H. cm | H. in |
|------------|------|-------|-------|-------|
| 906 05 013 | 21,5 | 8,1/2 | 21 | 8,1/4 |

**Supporto secchio Basic**

Basic champagne cooler stand
 Support pour seau à champagne Basic
 Basic Champagnenkühler Ständer
 Soporte para champañera Basic

Acciaio Inox 18/10 - St. Steel 18/10**Acciaio Inox - St. Steel**

| | ø cm | ø in | H. cm | H. in |
|---------------|------|-------|-------|--------|
| V01 05 20 674 | 21 | 8,1/4 | 63 | 24,3/4 |

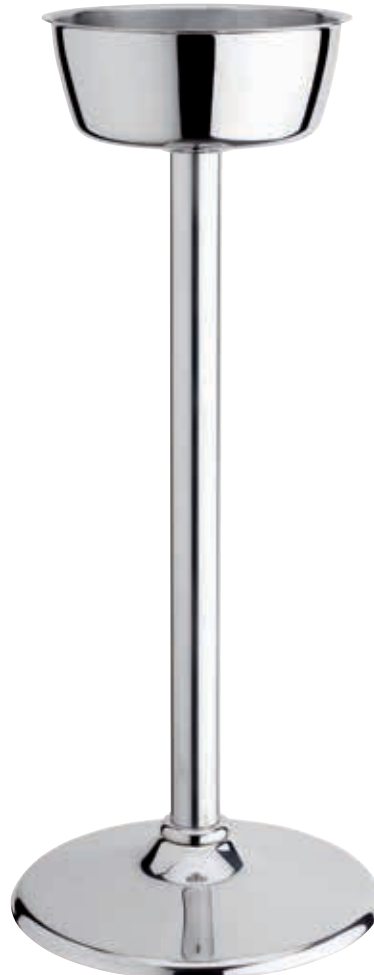

Cocktail shaker Basic

Basic cocktail shaker
Cocktail shaker Basic
Cocktail Shaker Basic
Coctelera Basic

Acciaio Inox - St. Steel

| | lt | oz |
|---------------------|-----|----|
| V78 05 81 SHA11 401 | 0,5 | 17 |



Misurino Basic

Basic jigger
Mésure Basic
Meßbecher Basic
Medida bar Basic

Acciaio Inox - St. Steel

| | ml | oz |
|----------------|----------|---------|
| V78 05 81 DOS1 | 25-50 ml | 0.8-1.7 |



● **PVD Rame - PVD Copper**

| | ml | oz |
|----------------|----------|---------|
| V78 40 81 DOS1 | 25-50 ml | 0.8-1.7 |

Molla ghiaccio Modern

Ice tongs
Pince à glaçons
Eiszange
Pinzas hielo

Acciaio Inox - St. Steel

| | mm | in |
|---------------|-----|-------|
| 903 05 81 MGH | 200 | 7,7/8 |

● **PVD Rame - PVD Copper**

| | mm | in |
|---------------|-----|-------|
| 903 40 81 MGH | 200 | 7,7/8 |



Molla ghiaccio Lux

Ice tongs
Pince à glace
Eiszange
Pinzas hielo

Acciaio Inox 18/10 - St. Steel 18/10

| | mm | in |
|---------------|-----|-------|
| 903 05 81 001 | 126 | 4,7/8 |

● **PVD Rame - PVD Copper**

| | mm | in |
|---------------|-----|-------|
| 903 40 81 001 | 126 | 4,7/8 |



Filtro cocktail Basic

Basic cocktail strainer
Passoire à cocktail Basic
Barsieb Basic
Colador de cóctel Basic

Acciaio Inox - St. Steel

| | mm | in |
|----------------|-----|-------|
| V78 05 81 FCO1 | 140 | 5,1/2 |

● **PVD Rame - PVD Copper**

| | mm | in |
|----------------|-----|-------|
| V78 40 81 FCO1 | 140 | 5,1/2 |



Vassoio da banco/bar pasticceria

Bar/pastry tray
Plateau bar/pâtisserie
Konditoreiplatte
Bandeja bar/pastelería

Acciaio inox 18/10 - St. steel 18/10

| | cm | H. cm | in | H. in |
|---------------|-------|-------|----------|-------|
| V01 05 23 P06 | 35x10 | 0,8 | 13.3/4x4 | 0,31 |

● **PVD Rame - PVD Copper**

| | cm | H. cm | in | H. in |
|---------------|-------|-------|----------|-------|
| V01 40 23 P06 | 35x10 | 0,8 | 13.3/4x4 | 0,31 |



Secchio spumante 1 bottiglia

Champagne bucket, 1-bottle
 Seau à champagne 1 bouteille
 Champagneschale (Für 1Flasche)
 Champañera 1 botella

| | cm | H. cm | in | H. in |
|---------------------------------|-------|-------|-------------|-------|
| V81 12 20 001 Plex -Transparent | 22x16 | 23,5 | 8,5/8x6,1/4 | 9,1/4 |
| V81 12 20 004 PS - Transparent | 22x16 | 23,5 | 8,5/8x6,1/4 | 9,1/4 |
| V81 12 20 007 PS Bianco - White | 22x16 | 23,5 | 8,5/8x6,1/4 | 9,1/4 |

**Secchio spumante Magnum**

Magnum bucket
 Seau Magnum
 Champagneschale Magnum
 Champañera Magnum

| | cm | H. cm | in | H. in |
|---------------------------------|-----------|-------|----------|-------|
| V81 12 20 002 Plex -Transparent | 27,9x17,3 | 23,4 | 11x6,7/8 | 9,1/4 |
| V81 12 20 005 PS - Transparent | 27,9x17,3 | 23,4 | 11x6,7/8 | 9,1/4 |
| V81 12 20 008 PS Bianco - White | 27,9x17,3 | 23,4 | 11x6,7/8 | 9,1/4 |

**Secchio spumante Jeroboam**

Jeroboam bucket
 Seau Jeroboam
 Champagneschale Jeroboam
 Champañera Jeroboam

| | cm | H. cm | in | H. in |
|---------------------------------|-----------|-------|----------|-------|
| V81 12 20 003 Plex -Transparent | 48,2x20,9 | 24,3 | 19x8,1/4 | 9,5/8 |
| V81 12 20 006 PS - Transparent | 48,2x20,9 | 24,3 | 19x8,1/4 | 9,5/8 |
| V81 12 20 009 PS Bianco - White | 48,2x20,9 | 24,3 | 19x8,1/4 | 9,5/8 |



Coppa punch

Punch bowl
Bol à punch
Punchschale
Champañera

Acciaio Inox 18/10 - St. Steel 18/10

| | ø cm | ø in | lt | oz |
|---------------|------|--------|----|-------|
| V77 05 52 PUN | 40 | 15,3/4 | 13 | 439,5 |

PVD Rame - PVD Copper

| | ø cm | ø in | lt | oz |
|---------------|------|--------|----|-------|
| V77 40 52 PUN | 40 | 15,3/4 | 13 | 439,5 |

**Coppa champagne con base**

Champagne-bottle holder with base
Coupe à champagne avec base
Champagnerschale mit Basis
Champañera con base

Acciaio Inox 18/10 - St. Steel 18/10

| | ø cm | ø in | lt | oz |
|----------------|------|--------|----|-----|
| V77 05 52 PUN3 | 53 | 20,7/8 | 25 | 845 |

**Coppa punch doppio corpo**

Punch bowl double-wall
Bol à punch double paroi
Doppelwandiger Punchschale
Champañera doble pared

Acciaio Inox 18/10 - St. Steel 18/10

| | ø cm | ø in | lt | oz |
|----------------|------|--------|----|-----|
| V77 05 52 PUN2 | 39 | 15,3/8 | 10 | 338 |

**Coppa champagne**

Champagne bottle holder
Coupe à champagne
Champagnerschale
Champañera

Acciaio Inox 18/10 - St. Steel 18/10

| | ø cm | ø in | lt | oz |
|----------------|------|--------|----|-----|
| V77 05 52 PUN1 | 53 | 20,7/8 | 25 | 845 |



Portacannucce

Straw holder
Porte-pailles
Trinkhalmbehälter
Portapajitas

Acciaio Inox 18/10 - St. Steel 18/10

| | ø cm | ø in | H. cm | H. in |
|---------------|------|-------|-------|-------|
| V01 05 71 011 | 9 | 3,1/2 | 11 | 4,3/8 |

**Portacucchiaini**

Tea spoon holder
Porte-cuillères à café
Kaffeelöffelbecher
Portacucharas café

Acciaio Inox 18/10 - St. Steel 18/10

| | ø cm | ø in | H. cm | H. in |
|---------------|------|-------|-------|-------|
| V01 05 71 008 | 9 | 3,1/2 | 8 | 3,1/8 |

**Spargicacao con coperchio in plastica**

Cocoa shaker with plastic cover
Saupoudreuse de cacao à couvercle en plastique
Kakaostreuer mit Plastikdeckel
Espolvoreador con tapa en plástico

Acciaio Inox 18/10 - St. Steel 18/10

| | ø cm | ø in |
|---------------|------|-------|
| 909 05 XX 028 | 5,3 | 2,1/8 |

**Vassoio tondo bar**

Round bar tray
Plateau rond bar
Austellplatte, rund
Bandeja redonda bar

Acciaio Inox 18/10 - St. Steel 18/10

| | ø cm | ø in |
|---------------|------|--------|
| V01 05 23 T32 | 32 | 12,5/8 |
| V01 05 23 T38 | 38 | 15 |

PVD Rame - PVD Copper

| | mm | in |
|---------------|----|--------|
| V01 40 23 T32 | 32 | 12,5/8 |
| V01 40 23 T38 | 38 | 15 |



Portabustine zucchero/tè

Packed sugar/tea holder
 Conteneur sachets de sucre/té
 Zucker und Teebeutel Behälter
 Portasobres de azúcar/té

Acciaio Inox 18/10 - St. Steel 18/10

| | cm | in | H. cm | H. in |
|---------------|--------|-------------|-------|-------|
| V78 05 04 PBU | 10x6,5 | 3,7/8x2,1/2 | 3,5 | 1,3/8 |

**Portatovaglioli Square**

Napkin holder
 Porte-serviettes
 Serviettenhalter
 Servilletero

Acciaio Inox 18/10 - St. Steel 18/10

| | cm | in | H. cm | H. in |
|---------------|------|-------------|-------|-------|
| V76 05 71 001 | 11x4 | 4,3/8x1,2/3 | 2 | 3,1/8 |

**PVD Rame - PVD Copper**

| | cm | in | H. cm | H. in |
|---------------|------|-------------|-------|-------|
| V76 40 71 001 | 11x4 | 4,3/8x1,2/3 | 2 | 3,1/8 |

Portatovaglioli da banco verticale

Vertical napkin holder
 Porte-serviettes vertical
 Vertikaler Thekenserviettenhalter
 Servilletero cuadrado vertical

Acciaio Inox 18/10 - St. Steel 18/10

| | cm | in | H. cm | H. in |
|------------|--------|-------------|-------|-------|
| 906 05 008 | 8,5x11 | 3,3/8x4,3/8 | 16 | 6,1/4 |

**Portatovaglioli Imperial**

Imperial napkin holder
 Porte-serviette Imperial
 Serviettenhalter Imperial
 Servilletero Imperial

Acciaio Inox 18/10 - St. Steel 18/10

| | cm | H. cm | in | H. in |
|---------------|------|-------|-------|-------|
| V01 05 71 105 | 10,5 | 9 | 4,1/8 | 3,1/2 |

**Denocciolatore**

Olive and cherry pitter
 Dénoyateur à olives Entkerner
 Entkerner
 Deshuesador aceitunas

Acciaio Inox 18/10 - St. Steel 18/10

| | mm | in |
|---------------|-----|-------|
| V78 05 81 DEN | 162 | 6,3/8 |



Cucchiaino ghiaccio Matisse piccolo

Matisse slotted ice spoon
Cuillère à glaçons perforée Matisse
Kleiner Eiswürfelloffel Matisse
Cuchara hielo perforada Matisse

Acciaio Inox 18/10 - St. Steel 18/10

| | mm | in |
|---------|-----|-------|
| CF1 251 | 170 | 6,5/8 |

● **PVD Rame - PVD Copper**

| | mm | in |
|------------|-----|-------|
| CF1 40 251 | 170 | 6,5/8 |

**Cucchiaino multiuso Matisse grande**

Matisse slotted spoon large
Cuillère à servir perforée Matisse grande
Großer Universallöffel Matisse
Cuchara para servir perforada Matisse grande

Acciaio Inox 18/10 - St. Steel 18/10

| | mm | in |
|---------|-----|-------|
| CF1 162 | 205 | 8,1/8 |

● **PVD Rame - PVD Copper**

| | mm | in |
|------------|-----|-------|
| CF1 40 162 | 205 | 8,1/8 |

**Cucchiaino miscelatore**

Stirrer spoon
Cuillère à mélange
Cuchara para mezclar
Rührer Löffel

Acciaio Inox 18/10 - St. Steel 18/10

| | mm | in |
|---------------|-----|-------|
| V78 05 81 MES | 250 | 9,7/8 |

● **PVD Rame - PVD Copper**

| | mm | in |
|---------------|-----|-------|
| V78 40 81 MES | 250 | 9,7/8 |

**Coltello agrumi Regis**

Regis citrus fruit knife
Couteau à agrumes Regis
Orangenmesser Regis
Cuchillo cítricos Regis

Acciaio Inox - St. Steel

| | mm | in |
|---------------|-----|-------|
| 903 05 84 269 | 220 | 8,5/8 |

● **PVD Rame - PVD Copper**

| | mm | in |
|---------------|-----|-------|
| 903 40 84 269 | 220 | 8,5/8 |

**Appetizer Double (cucchiaino forchettina)**

Double appetizer (spoon fork)
Cuillère de mise en bouche Double (cuillère fourchette)
Appetizerlöffel doppelt (Löffel & Gabel)
Aperitivo Double (cuchara tenedor)

Acciaio Inox 18/10 - St. Steel 18/10

| | mm | in |
|----------|-----|-------|
| CF7 PDFS | 122 | 4,3/4 |

● **PVD Rame - PVD Copper**

| | mm | in |
|-------------|-----|-------|
| CF7 P4 ODFS | 122 | 4,3/4 |

**Cucchiaino olive con fori**

Olive slotted spoon
Cuillère de mise en bouche olives perforée
Gelochter Oliven Löffel
Cuchara aceitunas perforada

Acciaio Inox 18/10 - St. Steel 18/10

| | mm | in |
|---------------|-----|-------|
| 903 05 81 AOF | 225 | 8,7/8 |

● **PVD Rame - PVD Copper**

| | mm | in |
|---------------|-----|-------|
| 903 40 81 AOF | 225 | 8,7/8 |





Set 12pz cannuce lucide + 1 scovolino

Mirror finished straw set 12-pc + 1 cleaner

Set 12pcs pailles polies +1 brosse

Set 12pzs pajitas pulidas +1 cepillo

12-teiliges Set Strohhalme; hochglanz poliert + 1 Reiniger

Acciaio Inox 18/10 - St. Steel 18/10

| | L. mm | ø mm | L. in | Ø in |
|---------------------|-------|------|-------|-------|
| cannuce/ straws | 215 | 6 | 8,1/2 | 2,3/8 |
| scovolino / cleaner | 200 | 6 | 7,7/8 | 2,3/8 |

9030573001

Dritte - straight - droites - rectas - gerade

9030573002

Con piega - pliées - dobladas - gebogen

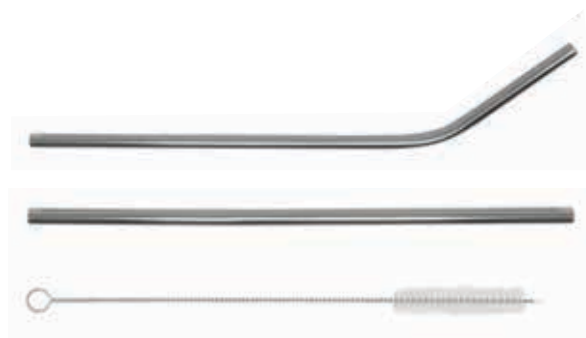

Set 12pz cannuce PVD Black + 1 scovolino

Black straw set 12-pc PVD + 1 cleaner
 Set 12pcs pailles Black PVD +1 brosse
 Set 12pzs pajitas Black PVD +1 cepillo
 12-teiliges Set Strohhalme; Black PVD + 1 Reiniger

Acciaio Inox 18/10 - St. Steel 18/10

| | L. mm | ø mm | L. in | ø in |
|---------------------|-------|------|-------|-------|
| cannuce/ straws | 215 | 6 | 8,1/2 | 2,3/8 |
| scovolino / cleaner | 200 | 6 | 7,7/8 | 2,3/8 |

903057300142 Dritte - straight - droites - rectas - gerade
 903057300242 Con piega - pliées - dobladas - gebogen

**Set 12pz cannuce PVD Copper + 1 scovolino**

Copper straw set 12-pc PVD + 1 cleaner
 Set 12pcs pailles Copper PVD +1 brosse
 Set 12pzs pajitas Copper PVD +1 cepillo
 12-teiliges Set Strohhalme; Kupfer PVD + 1 Reiniger

Acciaio Inox 18/10 - St. Steel 18/10

| | L. mm | ø mm | L. in | ø in |
|---------------------|-------|------|-------|-------|
| cannuce/ straws | 215 | 6 | 8,1/2 | 2,3/8 |
| scovolino / cleaner | 200 | 6 | 7,7/8 | 2,3/8 |

903057300140 Dritte - straight - droites - rectas - gerade
 903057300240 Con piega - pliées - dobladas - gebogen

**Set 12pz cannuce PVD Gold + 1 scovolino**

Gold straw set 12-pc PVD + 1 cleaner
 Set 12pcs pailles Gold PVD +1 brosse
 Set 12pzs pajitas Gold PVD +1 cepillo
 12-teiliges Set Strohhalme; Gold PVD + 1 Reiniger

Acciaio Inox 18/10 - St. Steel 18/10

| | L. mm | ø mm | L. in | Ø in |
|---------------------|-------|------|-------|-------|
| cannuce/ straws | 215 | 6 | 8,1/2 | 2,3/8 |
| scovolino / cleaner | 200 | 6 | 7,7/8 | 2,3/8 |

903057300141 Dritte - straight - droites - rectas - gerade
 903057300241 Con piega - pliées - dobladas - gebogen

**Set 12pz cannuce PVD Arcobaleno + 1 scovolino**

Arcobaleno straw set 12-pc PVD + 1 cleaner
 Set 12pcs pailles Arcobaleno PVD +1 brosse
 Set 12pzs pajitas Arcobaleno PVD +1 cepillo
 12-teiliges Set Strohhalme; Arcobaleno PVD + 1 Reiniger

Acciaio Inox 18/10 - St. Steel 18/10

| | L. mm | ø mm | L. in | Ø in |
|---------------------|-------|------|-------|-------|
| cannuce/ straws | 215 | 6 | 8,1/2 | 2,3/8 |
| scovolino / cleaner | 200 | 6 | 7,7/8 | 2,3/8 |

903057300181 Dritte - straight - droites - rectas - gerade
 903057300281 Con piega - pliées - dobladas - gebogen

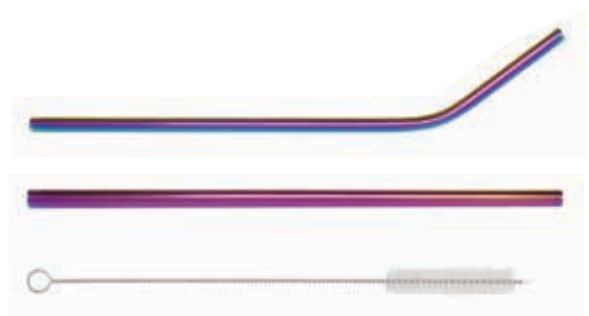

PASTRY

PASTRY

PASTRY







Alzata pasticceria

Petit four stand
Support à pâtisserie
Petits-Fours-Ständer
Presentación pastelería

Acciaio Inox 18/10 - St. Steel 18/10

| | ø cm | H. cm | ø in | H. in |
|---------------|------|-------|-------|-------|
| V36 05 41 012 | 12 | 13 | 4,3/4 | 5,1/8 |
| V36 05 41 112 | 12 | 18 | 4,3/4 | 7 |
| V36 05 41 216 | 16 | 8 | 6,1/4 | 3,1/8 |
| V36 05 41 016 | 16 | 13 | 6,1/4 | 5,1/8 |
| V36 05 41 116 | 16 | 18 | 6,1/4 | 7 |
| V36 05 41 122 | 22 | 8 | 8,5/8 | 3,1/8 |
| V36 05 41 022 | 22 | 13 | 8,5/8 | 5,1/8 |

PVD Oro - PVD Gold

| | ø cm | H. cm | ø in | H. in |
|---------------|------|-------|-------|-------|
| V36 41 41 112 | 12 | 18 | 4,3/4 | 7 |
| V36 41 41 016 | 16 | 13 | 6,1/4 | 5,1/8 |
| V36 41 41 122 | 22 | 8 | 8,5/8 | 3,1/8 |

**Alzata pasticceria 2 piani**

2-tier petit four stand
Support à pâtisserie à 2 étages
Petits-fours ständer 2-stufig
Presentación pastelería 2 pisos

Acciaio Inox 18/10 - St. Steel 18/10

| | ø cm | H. cm | ø in | H. in |
|---------------|-------|-------|-------------|-------|
| V36 05 41 201 | 16-12 | 17 | 6,1/4-4,3/4 | 6.3/4 |
| V36 05 41 202 | 22-16 | 17 | 8,5/8-6,1/4 | 6.3/4 |

PVD Oro - PVD Gold

| | ø cm | H. cm | ø in | H. in |
|---------------|-------|-------|-------------|-------|
| V36 41 41 201 | 16-12 | 17 | 6,1/4-4,3/4 | 6.3/4 |
| V36 41 41 202 | 22-16 | 17 | 8,5/8-6,1/4 | 6.3/4 |

**Alzata pasticceria 3 piani**

3-tier petit four stand
Support à pâtisserie à 3 étages
Kuchenständer 3-stufig
Presentación pastelería 3 pisos

Acciaio Inox 18/10 - St. Steel 18/10

| | ø cm | H. cm | ø in | H. in |
|---------------|----------|-------|-------------------|--------|
| V36 05 41 301 | 22-16-12 | 30 | 8,5/8-6,1/4-4,3/4 | 11.3/4 |

PVD Oro - PVD Gold

| | ø cm | H. cm | ø in | H. in |
|---------------|----------|-------|-------------------|--------|
| V36 41 41 301 | 22-16-12 | 30 | 8,5/8-6,1/4-4,3/4 | 11.3/4 |





Alzata torta

Cake stand
 Présentoir à gâteau
 Tortenplatte
 Presentación tarta

Acciaio Inox 18/10 - St. Steel 18/10

| | ø cm | H. cm | ø in | H. in |
|---------------|------|-------|--------|-------|
| V01 05 42 122 | 22 | 15 | 8,5/8 | 6 |
| V01 05 42 222 | 22 | 21 | 8,5/8 | 8,1/4 |
| V01 05 42 132 | 32 | 9 | 12,5/8 | 3,1/2 |
| V01 05 42 232 | 32 | 15 | 12,5/8 | 6 |

**Alzata torta 3 piani**

3-tier cake stand
 Présentoir à gâteau 3 étages
 Kuchenständer 3-stufig
 Presentación tarta 3 pisos

Acciaio Inox 18/10 - St. Steel 18/10

| | ø cm | H. cm | ø in | H. in |
|---------------|----------|-------|---------------------|--------|
| V01 05 42 301 | 22/32/42 | 43,5 | 8,5/8-12,5/8-16,1/2 | 17,1/8 |



Servitore té/pasticceria

Afternoon tea stand
Stand thé/pâtisserie
Tee/Kuchenstander
Soporte para platos

Acciaio Inox 18/10 - St. Steel 18/10

| | ø cm | H. cm | ø in | H. in | ø interno |
|---------------|------|-------|-------|--------|-----------|
| V76 05 42 004 | 25 | 40 | 9,7/8 | 15,3/4 | 21,8 |
| V76 05 42 005 | 30,6 | 42 | 12 | 16,1/2 | 18,3 |

**Alzata pasticceria**

Petit four stand
Support à pâtisserie
Petits-Fours-Ständer
Presentación pastelería

Acciaio Inox 18/10 - St. Steel 18/10

| | ø cm | H. cm | ø in | H. in |
|---------------|------|-------|-------|-------|
| V01 05 41 012 | 12 | 11 | 4,3/4 | 4,3/8 |
| V01 05 41 016 | 16 | 11,5 | 6,1/4 | 4,1/2 |
| V01 05 41 022 | 22 | 12 | 8,5/8 | 4,3/4 |

**Alzata pasticceria 2 piani**

2-tier petit four stand
Support à pâtisserie à 2 étages
Petits-fours ständer 2-stufig
Presentación pastelería 2 pisos

Acciaio Inox 18/10 - St. Steel 18/10

| | ø cm | H. cm | ø in | H. in |
|---------------|-------|-------|-------------|-------|
| V01 05 41 201 | 12/16 | 21,5 | 4,3/4-6,1/4 | 8,1/2 |
| V01 05 41 202 | 16/22 | 22,5 | 6,1/4-8,5/8 | 8,7/8 |

**Alzata pasticceria 3 piani**

3-tier petit four stand
Support à pâtisserie à 3 étages
Kuchenständer 3-stufig
Presentación pastelería 3 pisos

Acciaio Inox 18/10 - St. Steel 18/10

| | ø cm | H. cm | ø in | H. in |
|---------------|----------|-------|-------------------|--------|
| V01 05 41 301 | 12/16/22 | 31 | 4,3/4-6,1/4-8,5/8 | 12,1/4 |



Piatto torta con coperchio a bascula

Cake tray with roll top cover

Plateau à gâteaux avec cloche basculante

Kuchenplatte mit Rolltopphaube

Plato para tartas con campana roll top

Acciaio Inox 18/10 - St. Steel 18/10

| | ø cm | ø in |
|---------------|------|------|
| V76 05 42 003 | 38 | 15 |

Coperchio a bascula tondo trasparente

Transparent round rolltop cover

Cloche basculante ronde transparente

Rolltopphaube - rund

Campana redonda transparente

SAN

| | ø cm | ø in |
|---------------|------|--------|
| V76 12 15 T01 | 34 | 13,3/8 |

**Alzata torta con coperchio a bascula**

Cake stand with roll top cover

Présentoir à gâteaux avec cloche basculante

Kuchenplatte mit Schaukeldeckel

Soporte para tartas con campana roll top

Acciaio Inox 18/10 - St. Steel 18/10

| | ø cm | H. cm | ø in | H. in |
|---------------|------|---------|------|----------------|
| V76 05 42 002 | 38 | 12,5+32 | 15 | 4,7/8 + 12,5/8 |





Vassoio da banco/bar pasticceria

Bar/pastry tray
Plateau bar/pâtisserie
Konditoreiplatte
Bandeja bar/pastelería

Acciaio inox 18/10 - St. steel 18/10

Vassoi adatti a banchi di pasticceria, bar e gastronomia con angolo parete chiuso. Facili da pulire ed igienici.

Trays for pastry, bar & gastronomy counters with closed corners. hygienic and Easy to clean.

Acciaio inox 18/10 - St. steel 18/10

| | cm | H. cm | in | H. in |
|---------------|-------|-------|----------|-------|
| V01 05 23 P06 | 35x10 | 0,8 | 13.3/4x4 | 0,31 |

- PVD Oro - PVD Gold - V01 41 23 P06
- Vintage - V01 51 23 P06

Acciaio inox 18/10 - St. steel 18/10

| | cm | H. cm | in | H. in |
|---------------|-------|-------|----------|-------|
| V01 05 23 P01 | 50x10 | 0,8 | 19,3/4x4 | 0,31 |

- PVD Oro - PVD Gold - V01 41 23 P01
- Vintage - V01 51 23 P01

Acciaio inox 18/10 - St. steel 18/10

| | cm | H. cm | in | H. in |
|---------------|-------|-------|----------|-------|
| V01 05 23 P02 | 60x10 | 0,8 | 23.3/8x4 | 0,31 |

- PVD Oro - PVD Gold - V01 41 23 P02
- Vintage - V01 51 23 P02

Acciaio inox 18/10 - St. steel 18/10

| | cm | H. cm | in | H. in |
|---------------|-------|-------|-------------|-------|
| V01 05 23 P07 | 25x20 | 0,8 | 9.7/8x7.7/8 | 0,31 |

- PVD Oro - PVD Gold - V01 41 23 P07
- Vintage - V01 51 23 P07

Acciaio inox 18/10 - St. steel 18/10

| | cm | H. cm | in | H. in |
|---------------|-------|-------|--------------|-------|
| V01 05 23 P08 | 35x20 | 0,8 | 13.3/4x7.7/8 | 0,31 |

- PVD Oro - PVD Gold - V01 41 23 P08
- Vintage - V01 51 23 P08

Acciaio inox 18/10 - St. steel 18/10

| | cm | H. cm | in | H. in |
|---------------|-------|-------|--------------|-------|
| V01 05 23 P03 | 50x20 | 0,8 | 19.3/4x7.7/8 | 0,31 |

- PVD Oro - PVD Gold - V01 41 23 P03
- Vintage - V01 51 23 P03

Acciaio inox 18/10 - St. steel 18/10

| | cm | H. cm | in | H. in |
|---------------|-------|-------|--------------|-------|
| V01 05 23 P04 | 60x20 | 0,8 | 23.5/8x7.7/8 | 0,31 |

- PVD Oro - PVD Gold - V01 41 23 P04
- Vintage - V01 51 23 P04

Acciaio inox 18/10 - St. steel 18/10

| | cm | H. cm | in | H. in |
|---------------|-------|-------|--------------|-------|
| V01 05 23 P05 | 70x20 | 0,8 | 27.1/2x7.7/8 | 0,31 |

- PVD Oro - PVD Gold - V01 41 23 P05
- Vintage - V01 51 23 P05

Forbici servire pasticceria Lux

Lux pastry serving scissors
Ciseaux à servir gâteau Lux
Tijeras para servir pastelería Lux
Lux gebäck-Servierzange

Acciaio Inox 18/10 - St. Steel 18/10

| | mm | in |
|------------|-----|-------|
| 9030581FPS | 210 | 8,1/4 |

● **PVD Oro - PVD Gold**

| | mm | in |
|------------|-----|-------|
| 9034181FPS | 210 | 8,1/4 |

**Forbici servire pane Lux**

Lux bread serving scissors tongs
Pince ciseaux à servir pain Lux
Pinzas tijeras para servir pan Lux
Lux Brot Servierzange

Acciaio Inox 18/10 - St. Steel 18/10

| | mm | in |
|------------|-----|-------|
| 9030581FPA | 250 | 8,7/8 |

● **PVD Oro - PVD Gold**

| | mm | in |
|------------|-----|-------|
| 9934181FPA | 250 | 8,7/8 |

**Molla pasticceria Lux**

Lux pastry tongs
Pince à gâteau Lux
Lux Gebäckzange
Pinza para pastelería Lux

Acciaio Inox 18/10 - St. Steel 18/10

| | mm | in |
|------------|-----|-------|
| 9030581004 | 210 | 8,1/4 |

● **PVD Oro - PVD Gold**

| | mm | in |
|------------|-----|-------|
| 9034181004 | 210 | 8,1/4 |

**Molla pane Lux**

Lux bread tongs
Pince à pain Lux
Lux Brotzange
Pinzas pan Lux

Acciaio Inox 18/10 - St. Steel 18/10

| | mm | in |
|------------|-----|-------|
| 9030581007 | 210 | 8,1/4 |

● **PVD Oro - PVD Gold**

| | mm | in |
|------------|-----|-------|
| 9034181007 | 210 | 8,1/4 |

**Molla ghiaccio Lux**

Lux ice tongs
Pince à glace Lux
Lux Eiszange
Pinzas hielo Lux

Acciaio Inox 18/10 - St. Steel 18/10

| | mm | in |
|------------|-----|-------|
| 9030581001 | 126 | 4,7/8 |

**Pala torta Milord**

Milord cake server
Pelle à gâteaux Milord
Milord Tortenheber
Pala pastel Milord

Acciaio Inox 18/10 - St. Steel 18/10

| | mm | in |
|-------|-----|-------|
| C1439 | 240 | 9,1/2 |

● **PVD Oro - PVD Gold**

| | mm | in |
|---------|-----|-------|
| C144139 | 240 | 9,1/2 |



Vaso in vetro con coperchio

Glass jar with lid
Pot en verre avec couvercle
Jarrón de vidrio con tapa
Glasdose mit Deckel

Vetro - Glass

| | Ø cm | Ø in | H. cm | H. in |
|------------|------|-------|-------|--------|
| 4041031304 | 14 | 5,1/2 | 17,5 | 6,7/8 |
| 4041031305 | 14 | 5,1/2 | 23 | 9 |
| 4041031306 | 14 | 5,1/2 | 29,5 | 11,5/8 |



Vassoio con 3 porta bustine zucchero/te

Tray with 3 packed sugar/tea holders
Plateau avec 3 conteneurs sachets de sucre/té
Bandeja con 3 portasobres de azúcar/tè
Tablett mit 3 Behältern für Zucker/Tee

Acciaio Inox 18/10 - St. Steel 18/10

| | cm | in | H. cm | H. in |
|---------------|---------|-------------|-------|-------|
| V78 05 23 001 | 21,5x11 | 8,1/2x4,3/8 | 4 | 1,5/8 |



Portabustine zucchero/tè

Packed sugar/tea holder
Conteneur sachets de sucre/té
Zucker und-Teebeutel Behälter
Portasobres de azúcar/tè

Acciaio Inox 18/10 - St. Steel 18/10

| | cm | in | H. cm | H. in |
|---------------|--------|-------------|-------|-------|
| V78 05 04 PBU | 10x6,5 | 3,7/8x2,1/2 | 3,5 | 1,3/8 |



Portatovaglioli Square

Square napkin holder
Porte-serviettes Square
Square Serviettenhalter
Servilletero Square

Acciaio Inox 18/10 - St. Steel 18/10

| | cm | in | H. cm | H. in |
|---------------|------|-------------|-------|-------|
| V76 05 71 001 | 11x4 | 4,3/8x1,2/3 | 2 | 3,1/8 |



Portabrioche Domino da banco

Domino countertop croissants display case
Vitrine à viennoiserie Domino de comptoir
Expositor de pastelería Domino para mostrador
Domino Vitrine für Croissants

Acciaio 18/10 - St.Steel**Acciaio Verniciato - Varnished steel****SAN**

| | cm | in | H. cm | H. in |
|---------------|-------|---------------|-------|-------|
| V33 18 52 052 | 48x32 | 18,7/8x12,5/8 | 17 | 6,3/4 |

**Portabrioche Domino rialzato**

Domino croissants display case with stand
Vitrine à viennoiserie Domino avec support
Expositor de pastelería Domino con soporte
Domino-Croissant-Vitrine mit Ständer

Acciaio 18/10 - St.Steel**Acciaio Verniciato - Varnished steel****SAN**

| | cm | in | H. cm | H. in |
|---------------|-------|---------------|-------|-------------|
| V33 18 52 051 | 48x32 | 18,7/8x12,5/8 | 37 | 14,5/83,1/2 |



Jambee

Jambee
Jambee
Jambee
Jambee

Acciaio Inox 18/10 - St. Steel 18/10

| | lt | oz | cm | in |
|--------------|-----|----|-------------------------------------|--|
| V77 0552 DMB | 0,7 | 24 | 12,5x34,5 H Min 44,5 H Max 58 | 5x13,5/8 H Min 17,1/2 H Max 22,7/8 |
| V77 0552 DMC | 1 | 35 | 12,5x34,5 H Min 48 H Max 71,5 | 5x13,5/8 H Min 18,3/4 H Max 28,1/8 |

Erogatore a siringa

Syringe nozzle
Embout seringue
Ausgieberspritze
Boquilla jeringa

Acciaio Inox 18/10 - St. Steel 18/10**Z77 4652 DMA**

Alzata presentazione bianca Domino

Domino podium, white
 Présentoir Domino blanc
 Domino Podium, weiß
 Soporte presentación Domino blanco

Acciaio Verniciato - Varnished Steel

| | cm | H. cm | in | H. in |
|------------|-------|-------|--------------|-------|
| V331842030 | 20x40 | 9 | 7,7/8x15,3/4 | 3,1/2 |

**Alzata presentazione bianca Domino**

Domino podium, white
 Présentoir Domino blanc
 Domino Podium, weiß
 Soporte presentación Domino blanco

Acciaio Verniciato - Varnished Steel

| | cm | H. cm | in | H. in |
|------------|-------|-------|--------------|-------|
| V331842031 | 20x40 | 20 | 7,7/8x15,3/4 | 7,7/8 |

**Alzata presentazione bianca Domino**

Domino podium, white
 Présentoir Domino blanc
 Domino Podium, weiß
 Soporte presentación Domino blanco

Acciaio Verniciato - Varnished Steel

| | cm | H. cm | in | H. in |
|------------|-------|-------|--------------|-------|
| V331842032 | 20x60 | 9 | 7,7/8x23,5/8 | 3,1/2 |

**Alzata presentazione bianca Domino**

Domino podium, white
 Présentoir Domino blanc
 Domino Podium, weiß
 Soporte presentación Domino blanco

Acciaio Verniciato - Varnished Steel

| | cm | H. cm | in | H. in |
|------------|-------|-------|--------------|-------|
| V331842033 | 20x60 | 20 | 7,7/8x23,5/8 | 7,7/8 |



Gres Blue mix

| | cm | in |
|------------|-------|-------------|
| V332142003 | 20x20 | 7,7/8x7,7/8 |

**Gres Yellow mix**

| | cm | in |
|------------|-------|-------------|
| V332142006 | 20x20 | 7,7/8x7,7/8 |

**Gres Grey mix**

| | cm | in |
|------------|-------|-------------|
| V332142001 | 20x20 | 7,7/8x7,7/8 |

**Gres Light Grey**

| | cm | in |
|------------|-------|-------------|
| V332142004 | 20x20 | 7,7/8x7,7/8 |



Portabrioche singolo

Croissant tray

Plateau porte-croissants

Brot Büfettkorb

Bandeja de buffet

base pp - coperchio san**tray pp - lid san**

| | cm | in | H. cm | H. in |
|---------------|---------|---------------|-------|-------|
| V77 12 52 01P | 50x30,5 | 19,5/8x12,1/8 | 18,5 | 7,1/4 |
| V77 12 52 03P | 40x24,5 | 15,3x9,5/8 | 15,5 | 6,1/8 |

**Portabrioche doppio**

Double-deck croissant tray

Porte-croissants deux étages

Doppelsplatte Brot Büfettkorb

Bandeja de buffet con dos pisos

base pp - coperchio san**tray pp - lid san**

| | cm | in | H. cm | H. in |
|---------------|---------|---------------|-------|--------|
| V77 12 52 02P | 50x30,5 | 19,5/8x12,1/8 | 39 | 15,3/8 |

**Portabrioche tondo**

Round croissant tray

Porte-croissants rond

Brot Büfettkorb rund

Bandeja de buffet redonda

base pp - coperchio san**tray pp - lid san**

| | ø cm | ø in |
|----------------|------|--------|
| V77 12 52 0TP | 46 | 18,1/8 |
| V77 12 52 0TP1 | 38 | 15 |



Portaformaggi/affettati refrigerato singolo

Thermal food tray rectangular
 Porte-dîner rectangulaire réfrigérant individuel
 Wurstwarenplatte, rechteckig
 Bandeja port quesos/embutidos rectangular refrigerante individual

base pp - coperchio san
tray pp - lid san

| | cm | in | H. cm | H. in |
|---------------|---------|---------------|-------|-------|
| V77 12 54 01P | 50x30,5 | 19,5/8x12,1/8 | 18,5 | 7,1/4 |

**Portaformaggi/affettati refrigerato doppio**

Thermal food tray rectangular, double
 Porte-dîner rectangulaire réfrigérant double
 Doppelwurstwarenplatte, rechteckig
 Bandeja port quesos rectangular refrigerante doble

base pp - coperchio san
tray pp - lid san

| | cm | in | H. cm | H. in |
|---------------|---------|---------------|-------|--------|
| V77 12 54 02P | 50x30,5 | 19,5/8x12,1/8 | 39 | 15,3/8 |

**Eutettici rettangolari**

Ice packs
 Blocs réfrigérants
 Kühllakkus
 Acumuladores de frío rectangulares

V77 12 95 G00

**Base coprieutettici per portaformaggi refrigerato**

Ice pack cover for termale rectangular cheese dish
 Base couvre blocs réfrigérants pour porte-dimer réfrigérant
 Kühllakkus scheinbe für Wurstwaremplate, rechteckig
 Base para acumuladores de frío para bandeja port quesos refrigerante

Acciaio Inox 18/10 - St. Steel 18/10

| | cm | in |
|---------------|---------|--------------|
| Z77 19 54 01P | 43,5x24 | 17,1/8x9,1/2 |



Certificato

La SQS attesta che l'organizzazione di seguito indicata dispone di un sistema di gestione conforme ai requisiti della base normativa menzionata.



Abert S.p.A.
Via Don P. Mazzolari, 17 (Zona Industriale)
25050 Passirano (BS)
Italia

Ulteriori siti riportati in appendice

Campo di applicazione

Divisione Abert
Sito di Via Don P. Mazzolari, 17, 25050 Passirano (BS)

Progettazione, fabbricazione e commercializzazione di posate, complementi per la tavola, vasellame, caffettiere e pentolame.

Base normativa

ISO 9001:2015 Sistema di gestione per la qualità

No. di reg. H30537

Validità 13.11.2019 - 10.11.2022
Emissione 13.11.2019

A. Girani, Presidente SQS

F. Müller, CEO SQS



Associazione Svizzera per Sistemi di Qualità e di Management (SQS)
Bernostrasse 103, 3052 Zollikofen, Svizzera



Partner of



THE INTERNATIONAL CERTIFICATION NETWORK

CERTIFICATE

SQS has issued an IQNet recognized certificate that the organization:

Abert S.p.A.
Via Don P. Mazzolari, 17 (Zona Industriale)
25050 Passirano (BS)
Italy

has implemented and maintains a
Management System

for the following scope:

Further sites according to appendix SQS

which fulfills the requirements of the following standard(s):

ISO 9001:2015

Issued on: 2019-11-13
Expires on: 2022-11-10

This attestation is directly linked to the IQNet Partner's original certificate and shall not be used as a stand-alone document

Registration Number: CH- H30537



Alex Stoichitciu
President of IQNet

Felix Müller
CEO SQS



SQS® Partner®
AENOR Spain AFNOR Certification France APCER Portugal CCC Cyprus CIBQ Italy
CQC China CQM China CQS China Republic Of Cert Centre DQS Holding GmbH Germany EAGLE Certification Group USA
FCAI Brazil FONDORAMA Venezuela ICORTEX Colombia Inspectorat Serbisinski Og Finland INTECO Costa Rica
IRAM Argentina JAS-Anqos SQA Korea METEC Geneva NISIT Hungary Normas AS Norway NISK Ireland
NYCE-SIGE Mexico PCBC Poland Quality Austria Austria QR Russia SH Israel SIQ Slovenia
SIREM QAS International Malaysia SQS Switzerland SRAQ Romania TEST S/Potenzburg Russia TIC Turkey YUQS Serbia

* The list of IQNet partners is valid at the time of issue of this certificate. Updated information is available under www.iqnet-certification.com

abert

www.abert.it