



Broggi 1818

Broggi Catalogo 2020

Sommario

| | |
|--|-----|
| La Storia | 007 |
| The Story | |
| Posateria | 011 |
| Flatware | |
| Contemporary - Stainless Steel..... | 015 |
| Classic - Stainless Steel..... | 041 |
| Alpacca - EPNS..... | 063 |
| Finiture speciali | 095 |
| Special finishes | |
| Posateria - Flatware..... | 095 |
| Vasellame - Hollowware..... | 109 |
| Vasellame | 119 |
| Hollowware | |
| Mix & Match..... | 119 |
| Essenza..... | 131 |
| Cestini pane - Bread baskets..... | 138 |
| Vassoio in carbonio - Carbon fibre tray..... | 141 |
| Vassoio Pigreco - Pigreco tray..... | 145 |
| Podium..... | 149 |
| Ginco..... | 153 |
| Zeta..... | 174 |
| Koku..... | 187 |
| Iseo..... | 191 |
| Classica Alpacca - EPNS..... | 233 |
| Rubans Alpacca - EPNS..... | 269 |
| Aqva..... | 313 |
| Gennaro..... | 319 |
| Buffet | 279 |
| Nature..... | 281 |
| Aqva..... | 313 |
| Zeta..... | 321 |
| Manhattan..... | 335 |
| Iseo..... | 347 |
| Italo..... | 369 |
| Carrelli | 381 |
| Trolleys | |
| Pigreco..... | 383 |
| Classica..... | 403 |

Broggi oggi Dove l'arte di ieri si fonde con le linee del domani

Da oltre 200 anni la nostra azienda produce oggetti per la tavola unici e raffinati: una storia di prestigio e di grandi successi. Da sempre i nostri prodotti racchiudono la professionalità dei maestri argentieri d'altri tempi, prodotti curati, dalle linee classiche e raffinate che ben si adattano alle tavole di alberghi lussuosi e di gran classe.

Marchio storico, pur rispettando le linee guida originarie, non rimane ancorato al ricordo degli sfarzi del passato; professionalità e dedizione non cambiano, ma la continua attenzione ed il monitoraggio delle nuove tendenze di design contribuiscono a darne oggi un'immagine dinamica e in costante evoluzione. Accanto ai decori e ai rilievi delle linee più classiche, collezioni storiche che hanno lasciato il segno nella tradizione alberghiera internazionale, nascono linee nuove dai tratti lineari, superfici lisce e forme di design che fanno dell'Azienda argenteria un nome della tradizione sempre più orientato al futuro.

Valori e filosofia aziendale

Il nostro obiettivo è essere vicino al cliente, per capirlo, per aiutarlo, per soddisfarlo con prodotti di grande qualità e fascino. Proponiamo articoli di grande e riconosciuta qualità, articoli che sappiano stupire, articoli ideati per soddisfare ogni esigenza, articoli che sono il frutto del lavoro dei nostri tecnici più esperti che non lasciano niente al caso.

La nostra forza

La qualità: la qualità dei materiali, la precisione delle forme, il fascino delle linee, l'attenzione ai particolari, la sicurezza di un prodotto unico che sa soddisfare anche i più esigenti.

Il know how e la tradizione: dal 1818 abbiamo fatto della lavorazione dell'argento ieri e dell'acciaio e dell'alpacca oggi una vera e propria filosofia di vita. Dall'abilità dei maestri argentieri di una volta, i nostri tecnici hanno ereditato la passione che fa di un semplice oggetto un'opera d'arte.

Flessibilità: da sempre la nostra attenzione è rivolta al cliente: abbiamo imparato ad ascoltare il mercato, ad ascoltarlo attentamente per riuscire a capire dove sta andando e cosa i nostri clienti si aspettano da noi.

Il made in Italy: perché siamo italiani e italiani sono i nostri prodotti, perché la nostra qualità è riconosciuta in tutto il mondo, perché facciamo parte di quella grande famiglia di produttori italiani che all'estero sono conosciuti ed ammirati come portatori di tradizione e qualità.

Il design: dal fascino delle linee più classiche ai tratti lineari di quelle più al passo con i tempi, dai decori del passato alle superfici lisce dell'era moderna senza dimenticare la particolare attenzione all'ergonomia delle forme. Per un prodotto che sa adattarsi ad ogni ambiente, classico o moderno, privato o pubblico.

Storia

1818 E' in quest'anno che Gaetano Broggi, allora giovane



Broggi Today Where Yesterday's Art Meets Tomorrow's Trends

For over 200 years our company has manufactured unique and refined tableware: a story of prestige and great achievements. Our products have always conveyed the professionalism of master silversmiths of other times: well-finished products, with the classical and refined lines that are well suited to the tables of luxury and high-end hotels. A historical brand, while respecting the original guidelines, does not remain anchored to the memory of the magnificence of the past; professionalism and dedication remain unchanged, however, today, the continuous attention and the monitoring of new design trends contribute to give it a dynamic and constantly evolving image. In addition to the decorations and reliefs of the most classical lines, historical collections that have left their mark the international hotels tradition, new lines with linear sections arise; smooth surfaces and design shapes that make the silversmith company a name of tradition more and more oriented to the future.

Core values and company philosophy

Our aim is being close to our customers, in order to comprehend them, to assist them, meet their needs with charming and quality products. We offer high and renowned quality items, which are able to impress, items created in order to fulfill any requirements, that are the fruit of the work of our most experienced technicians who leave nothing to chance.

Our strength

Quality: the quality of the materials, the precisions of shapes, the charm of lines, the attention to detail, the reliance on a unique product that can satisfy even the most demanding ones.

Know how and Tradition: since 1818 we have made of silver working yesterday and of steel and electro-plated stainless steel a real philosophy of life today. From the ability of the onetime master silversmiths, our technicians inherited the passion that makes an artwork from a simple object.

Flexibility: we have always focused on our customers; we have learned to listen to the market, and to listen to it carefully, in order to be able to understand where the market is going and what our customers expect from us.





Made in Italy: because we are Italian and our products are Italian, because our quality is renowned all over the world, because we belong to that big family of Italian manufacturers that abroad are known and admired as bearers of tradition and quality.

Design: from the charm of the more classical lines to the linear features of the models more in tune with the times, from the past decorations to the smooth surfaces of modern times, without forgetting the particular attention to the ergonomics of shapes. For products that can suit well with any ambiance, classical or modern, private or public.

History

1818 It is in this year that Gaetano Broggi, at the time a young man, enterprising and full of dreams, opens a silversmithing workshop in Milano, crafting tableware and sacred objects exclusively. Each object is handmade, thought of and carried out by Gaetano Broggi's experienced hands and his apprentices'.

1841 Over the years, the quality of craftsmanship increases the number of customers until they serve the Royal houses: from the Sforzas, historical noble family from Milano, to the Habsburgs in the nearby Austria, until they become official suppliers of the Curia in Milano. Important orders for products that are not only an accessory for the table but can be a real 'status symbol' of the class that counts.

1866 Prestige products, with a recognizable quality, an ever increasing demand, cause Broggi to move to a more spacious area, allowing a wider scale production. From the 1920s workshop, the dream of Gaetano Broggi turns into reality until it becomes what it is today: a company employing many staff.

1920 Word gets around in the elite milieus at the time and Broggi becomes the official supplier to luxurious cruise ships, Andrea Doria, Rex and Michelangelo, and to the most famous hotels on the French Riviera. People who matter, the pretty people recognize the quality and the prestige of a brand that is making history.

1960 The Sixties economic boom and the widespread economic prosperity, take Broggi collections on the most elegant and refined tables of the Italian wealthy families. A steadily growing market which makes Broggi one of the leader companies in the high-end cutlery sector.

1993 Broggi is acquired by Abert S.p.A., an important industrial group, a strategic choice which opens the borders to an ever-expanding market.

2000 Broggi headquarters are moved permanently to Passirano, Brescia province, and an optimisation process of the production is put into action through important investments; an era of change and innovation of the style of products begins: to historical and classical lines are added contemporary and essential-taste models, in which, however, elegant and graceful features are clearly visible, a natural legacy of a past made of valuable mastery and technique.

2018 Broggi celebrates an important achievement: 200 years of history, tradition, passion and innovation. Now brand leader in Italy - and also main character of Italianness in the world - of exclusive products that have made the history of the mise en place, today is contributes to making unique the tables of some of the most prestigious hotels and restaurants, cruise ships and exclusive private homes.

All steel products manufactured by Broggi 1818 are made of AISI 304 (18/10 stainless steel), an austenitic chromium-nickel alloy. Stainless steel derives its name from its ability to resist corrosion far more than any other steel. All knives by Broggi 1818 are made of AISI 420, a martensitic steel used for manufacturing solid-handle knives and the blades of hollow-handle knives. The advantage is its remarkable hardness obtained after suitable hardening treatments. This guarantees that knife blades have a better grip of the cutting edge and enhanced cutting capacity.

Tous les produits en acier réalisés par Broggi 1818 sont en AISI 304 (acier inox 18/10), un alliage austénitique contenant chrome et nickel. L'acier inoxydable tire son nom de la capacité de résister à la corrosion beaucoup plus que n'importe quel acier. Tous les couteaux réalisés par Broggi 1818 sont en AISI 420, acier martensitique qui est utilisé pour la fabrication de couteaux monobloc et pour les lames des couteaux à manche creux. Sa qualité est sa dureté considérable qu'il acquiert après les traitements opportuns de trempe. Ceci garantit aux lames des couteaux une plus grande tenue du fil tranchant et une majeure capacité de coupe.

Todos los productos de acero realizados por Broggi 1818 son de AISI 304 (acero inox 18/10), una aleación austenítica que contiene cromo y níquel. El acero inoxidable toma este nombre por la capacidad de resistir a la corrosión mucho más que cualquier otro acero. Todos los cuchillos realizados por Broggi 1818 están elaborados con AISI 420, acero martensítico que es utilizado para la fabricación de cuchillos monobloque y para las hojas de cuchillos de mango cóncavo. El valor está en la notable dureza que adquiere después de los oportunos tratamientos de temple. Ello garantiza a las hojas de los cuchillos una mayor duración del filo cortante y una mayor capacidad de corte.

Alle von Broggi 1818 realisierten Stahlprodukte sind aus AISI 304 (rostfreier 18/10 Stahl) und bestehen aus einer Austenit Legierung, die Chrom und Nickel enthält. Der rostfreie oder sogenannte INOX Stahl verdankt seinen Namen der außergewöhnlichen Korrosionsfestigkeit, die höher als bei jedem anderen Stahl ist. Alle Broggi 1818 Messer sind aus AISI 420, Martensit Stahl, der bei der Herstellung von Messern aus einem Block und Klingen von Messern mit Hohlgriff eingesetzt wird. Der Werkstoff verdankt seine besondere Härte entsprechenden Härtungsprozessen während der Verarbeitung. Dadurch bleibt die Klinge länger scharf und das Messer schneidet besser und präziser.

Posateria

Acciaio - 18/10

Cutlery - St. Steel
Couverts - Acier Inox
Cubiertos - Acero Inox
Besteck - Edelstahl

Tutti i prodotti in acciaio realizzati da Broggi 1818 sono in AISI 304 (acciaio inox 18/10), lega austenitica contenente cromo e nichel. L'acciaio inossidabile deriva il suo nome dalla capacità di resistere alla corrosione molto più di qualunque altro acciaio. Tutti i coltelli realizzati da Broggi 1818 sono in AISI 420, acciaio martensitico che viene utilizzato per la fabbricazione di coltelli monoblocco e per le lame dei coltelli a manico cavo. Il pregio è la sua notevole durezza che acquista dopo gli opportuni trattamenti di tempra. Ciò garantisce alle lame dei coltelli una maggiore tenuta del filo tagliente ed una maggior capacità di taglio.

Cutlery manufacturing process

Shearing (1) is the first step in the process of manufacturing forks and spoons. Rolling (2) is used to reduce the bowl thickness compared to that of the handle, and the next step is trimming (3) to give the shape of a bowl or prongs to the laminated implement. The final step is coining (4) during which the implement is shaped and ornamentation stamped. To make forged solid-handle knives the process begins by shearing a bar into a blank (1) that is then hot coined (2) so as to give it some initial shape. Afterwards the handle is sheared (3) and the blade is stretched (4). Then, the blade is sheared (5) so that it takes its final shape. Now blade serration (6) needs to be defined and the knife has to be polished as usual. The first step to make forged hollow-handle knives is shearing the shells (1). The two half-shells that will form the hollow handle are cold-coined (2) to obtain the convexity and stamp the decoration; afterwards the shells are coupled and welded (3). And that is how the knife handle is ready. Finally and by using a self-locking compound the blade, made applying the same techniques used to make forged solid-handle knives, is coupled and welded to the handle (4).

Cycle de production couverts

Le cycle de production de fourchettes et cuillères commence par l'opération de découpage (1). Afin de diminuer l'épaisseur du cuilleron par rapport au manche, on procède ensuite au laminage (2), et on continue avec l'ébarbage (3), pour donner la forme du cuilleron ou des dents au couvert laminé. Finalement, on passe au calibrage (4), au cours duquel on donne la forme et les décorations nécessaires. Pour l'usinage des couteaux monobloc forgés on commence par le découpage du rond en un tronçon (1), qui est successivement calibré à chaud (2), de façon à lui donner une première forme. On continue avec le découpage du manche (3) et avec l'étirement de la lame (4) ; par la suite, on réalise le découpage de la lame (5), de façon à lui donner sa forme réelle. À ce moment-là, il ne reste plus qu'à définir la dentelure sur la lame (6) et achever le couteau avec les normales opérations de nettoyage. Les phases d'usinage des couteaux à manche creux forgés commencent par le découpage des plaquettes (1). Les deux plaquettes qui constitueront le manche creux sont calibrées à froid (2), pour leur donner la convexité et les décorations; ensuite, elles sont accouplées et soudées (3) : voici le manche du couteau. Finalement, à travers un composant autobloquant, la lame, produite avec les mêmes techniques que les couteaux monobloc forgés, est assemblée et soudée au manche (4).

Ciclo de producción cubiertos

El ciclo de producción de tenedores y cucharas inicia con la operación de tronzado (1). Para reducir el grosor de la taza con respecto al mango, se procede luego al laminado (2), y se prosigue con el recorte (3), para dar la forma de la taza y de los dientes al cubierto laminado. Finalmente se pasa a la acuñación (4), en el curso de la cual se confiere la forma y las decoraciones necesarias. Para la elaboración de los cuchillos monoblock forjados se comienza con el tronzado de la varilla para obtener un fragmento (1), que sucesivamente es acuñado en caliente (2), para conferirle una forma inicial. Se prosigue con el tronzado del mango (3) y con el alargamiento de la hoja (4); a continuación se lleva a cabo el tronzado de la hoja (5), para conferirle la forma real. A estas alturas queda por definir el dentado de la hoja (6) y acabar el cuchillo con las normales operaciones de pulido. Las fases de elaboración de los cuchillos de mango cóncavo forjado comienzan con el tronzado de las valvas (1). Las dos valvas que constituyen el mango cóncavo son acuñadas en frío (2), para conferirles la convexidad y las decoraciones, y luego son acopladas y soldadas (3): he aquí el mango del cuchillo. Finalmente, a través de un compuesto auto-bloqueador, la hoja es ensamblada y soldada al mango (4), producida con las mismas técnicas de los cuchillos monoblock forjados.

Produktionszyklus besteck

Der Produktionszyklus von Gabeln und Löffeln beginnt mit dem Schnittvorgang (1). Die Stärke der Löffelschale im Verhältnis zum Griff wird durch Walzen (2) verkleinert, dann erfolgt das Beschneiden (3), zur Formgestaltung der Löffelschale bzw. der Zinken der Gabel. Bei der anschließenden Prägung (4) werden den Besteckelementen Form und Dekordetails verliehen. Bei der Fertigung von geschmiedeten Messern aus einem Block beginnt man mit dem Schnitt des Rundteils in ein Bruchstück (1), das dann durch Warmprägung (2) eine erste Form erhält. Darauf folgen der Schnitt des Griffs (3) und die Verlängerung der Klinge (4); der anschließende Zuschnitt der Klinge (5) verleiht dieser die tatsächliche bzw. endgültige Form. In abschließenden Arbeitsschritten wird die Sägestaltung an der Klinge (6) durchgeführt und das Messer mit den üblichen Reinigungsabläufen fertiggestellt. Die Bearbeitung von geschmiedeten Messern mit Hohlgriff beginnt mit dem Schnitt der Schalen (1). Die beiden Schalen, aus denen später der Hohlgriff besteht, erhalten durch Kaltprägung (2) die passende Höhlung und Dekorgestaltung und werden dann zusammengesetzt und gelötet (3): damit ist der Messergriff erstellt. Mit einem Selbstklebergemisch wird die Klinge, die mit der gleichen Arbeitstechnik von geschmiedeten Messern aus einem Block entstanden ist, am Messer angebracht und angelötet.

Broggi

Fasi di lavorazione

Il ciclo di produzione di forchette e cucchiai inizia con l'operazione di tranciatura (1). Per diminuire lo spessore della tazza rispetto al manico, si procede poi con la laminazione (2), e si prosegue con la rifilatura (3), per dare la forma della tazza o dei rebbi alla posata laminata. Infine si passa alla coniazione (4), nel corso della quale vengono dati la forma e i decori necessari. Per la lavorazione dei coltelli monoblocco forgiati si parte con la tranciatura del tondino in uno spezzone (1), che viene successivamente coniato a caldo (2), in modo da conferirgli una prima forma. Si prosegue con la tranciatura del manico (3) e con l'allungamento della lama (4); in seguito viene effettuata la tranciatura della lama (5), in modo da darle la forma reale. A questo punto rimane da definire la seghettatura sulla lama (6) e rifinire il coltello con le normali operazioni di pulitura. Le fasi di lavorazione dei coltelli a manico cavo forgiati parte con la tranciatura delle valve (1). Le due valve che costituiranno il manico cavo vengono coniate a freddo (2), per dare loro la convessità e i decori, e poi vengono accoppiate e saldate (3): ecco il manico del coltello. Infine, attraverso un composto autobloccante, viene assemblata e saldata al manico la lama (4), prodotta con le stesse tecniche dei coltelli monoblocco forgiati.

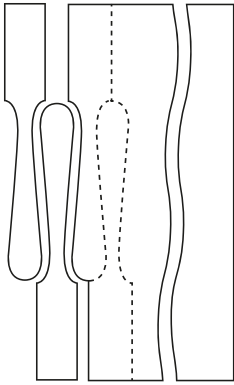

1
Tranciatura
Blank cutting

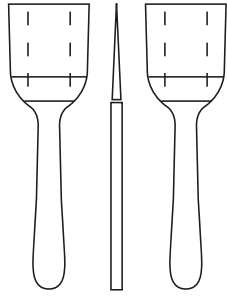

2
Laminazione
Rolling operation

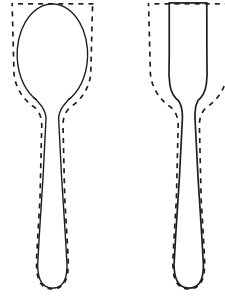

3
Rifilatura
Overall cutting on outside blank

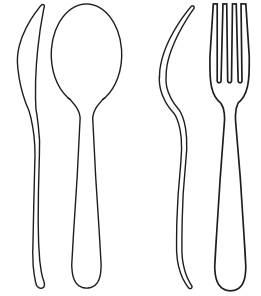

4
Coniatura
Pressing operation

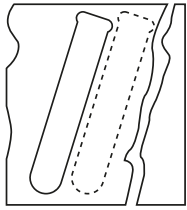

5
Tranciatura
Blank cutting



6
Coniatura manico
Handle pressing



7
Saldatura gocce
Soldering of shells

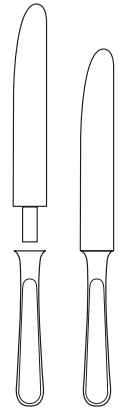

8
**Assemblaggio e saldatura
lama manico cavo**
Hollow handle knife
assembling and soldering



9
Tranciatura spezzone
Rod cutting

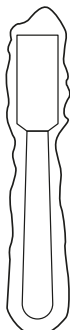

10
Coniatura a caldo
Forging

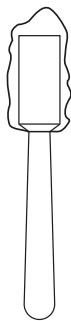

11
Tranciatura manico
Blank cutting of the blade

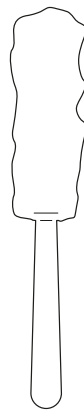

12
Laminazione
Rolling of the blade

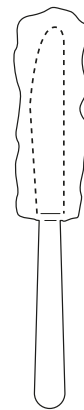

13
Ritanciatura lama
Second blank cutting of the blade

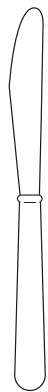

14
Seghettatura e finitura
Blade grinding and finishing



Contemporary

Acciaio - 18/10 St. Steel



Bygones
®



decenta

Acciaio inox 18/10
stainless steel 18/10
cod. 200.05.

acciaio argentato
electro-plated stainless steel (EPSS)
cod. 200.07.

DESIGN: OSVALDO FERRARIS



The collection was born from an idea by the Maestro, combining design and function with a new element: each piece of cutlery has a specific use. The risotto spoon in order to taste, at last, the sauce as well. The spaghetti spoon and fork, a modern and fashionable couple. The tongs that allow to savor hors d'oeuvres and fried food without piercing them. The steak set with the famous two-prong fork and the rigorously scalpel-shaped steak knife, in order not to fray the meat. The ambidextrous fish knife, created to meet with the needs of a left-handed person and divide the fish with just one touch. The philosophy that inspired the design of the series is the one of the chopstick. Handles and knobs are actually references to the famous Japanese object, while bowl and prongs maintain, in their lines, all the rich gastronomic Italian tradition.

La collection naît d'une idée du Maestro qui conjugue design et fonctionnalité avec un élément neuf: chaque couvert a une utilisation spécifique. La cuillère risotto pour goûter enfin même le condiment. La cuillère et la fourchette spaghetti, couple moderne et actuel. La pince personnelle qui consent de savourer des hors-d'œuvre et des fritures sans les embrocher. Le couple viande avec la fameuse fourchette à deux dents et le couteau beefsteak rigoureusement en «bistouri», pour ne pas effiloche la viande. Le couteau à poisson ambidextre, conçu pour venir à la rencontre de l'exigence d'un gaucher et séparer le poisson d'un seul geste. La philosophie qui a inspiré le design de la série est celle du chopstick. Les manches et les queues sont en effet des citations du fameux objet japonais, tandis que les tasses et les dents conservent dans leur ligne toute la savante tradition gastronomique italienne.

Nace de una idea del Maestro que conjuga design y funcionalidad con un elemento nuevo: cada cubierto tiene un empleo específico. La cuchara risotto para saborear finalmente también el condimento. La cuchara y el tenedor espaguetis, pareja moderna y actual. Las pinzas personales que permiten saborear entrantes y frituras sin ensartarlos. La pareja carne con el famoso tenedor de dos dientes y el cuchillo bistec rigurosamente tipo "bisturí", para no deshilar la carne. El cuchillo para pescado ambidiestro, concebido para salir al encuentro de las exigencias de un zurdo y separar con un solo toque el pescado. La filosofía que ha inspirado el design de la serie es la de un chopstick. Los mangos y espigas son de hecho citas del famoso objeto japonés, mientras que las tazas y los dientes conservan en sus líneas toda la sabia tradición gastronómica italiana.

Die Kollektion geht auf eine Idee des Meisters zurück, die Design und Zweckmäßigkeit mit einem völlig neuen Element vereint: jedes Besteckteil ist für einen ganz besonderen Verwendungszweck bestimmt. Der Risottolöffel erleichtert das Servieren in Portionen und das gleichmäßige Verteilen von Einlagen/Saucen, die den Risotto anreichern. Der Löffel wird im raffinierten Set mit der Spaghettigabel präsentiert. Die praktische Greifzange ist für das bequeme Verkosten von Vorspeisen und frittierten Appetizern gedacht. Das Fleischset besteht aus der üblichen langen Gabel mit zwei Zinken und dem klassischen, wie ein Seziermesser gestaltetem Steakmesser zum perfekten Tranchieren des Filets. Das Fischmesser ist auch für Linkshänder gedacht und ermöglicht das einfache und mühelose Zerteilen des Fisches. Die Philosophie, die dieses Design inspiriert, steht im 'Chopstick' Zeichen: Griffe und Stiele verweisen auf die berühmte japanische Formgestaltung, während die Hohlflächen und Zinken in ihren Linien voll und ganz der reichen italienischen Tradition verbunden sind.

Gualtiero

Marchesi

Oriental **inspirations** for unusual **tools**

Nasce da un'idea del Maestro che coniuga design e funzionalità con un elemento nuovo: ogni posata ha un utilizzo specifico. Il cucchiaio risotto per gustare finalmente anche il condimento. Il cucchiaio e la forchetta spaghetti, coppia moderna e attuale. La pinza personale che consente di assaporare antipasti e fritti senza infilarli. La coppia carne con la famosa forchetta a due rebbi ed il coltello bistecca rigorosamente a "bisturí", per non sfilacciare la carne. Il coltello pesce ambodestro, ideato per venire incontro all'esigenza di un mancino e separare con un solo tocco il pesce. La filosofia che ha ispirato il design della serie è quella di un chopstick. Manici e codoli sono infatti citazioni del famoso oggetto giapponese, mentre tazze e rebbi conservano nelle loro linee tutta la sapiente tradizione gastronomica italiana.





Tavola - Table Set

acciaio inox 18/10
stainless steel 18/10
cod. 117.05.

acciaio argentato
electro-plated stainless steel (EPSS)
cod. 117.07.

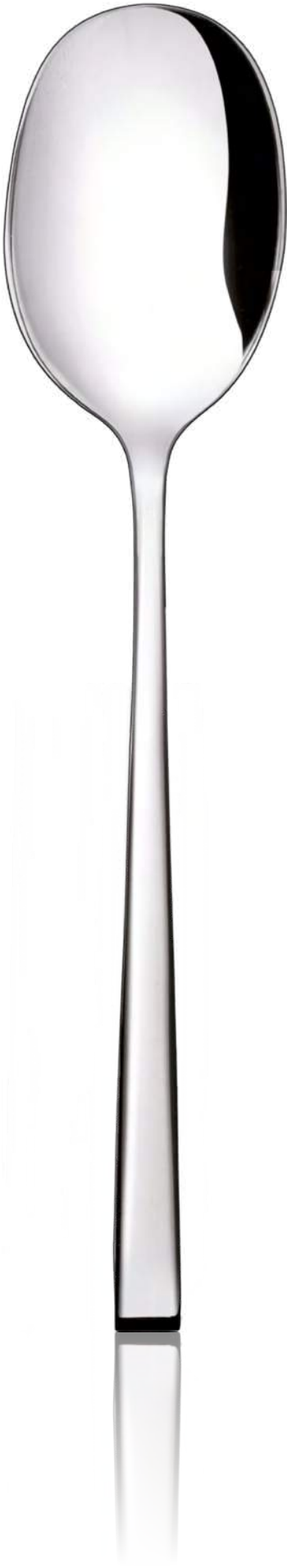
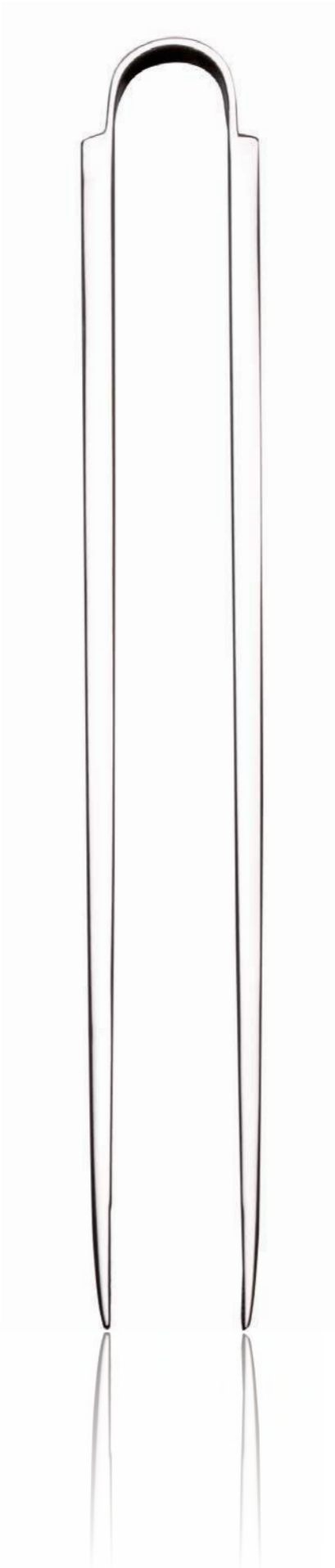







Stiletto

acciaio inox 18/10
stainless steel 18/10
cod. 113.05.

acciaio argentato
electro-plated stainless steel (EPSS)
cod. 113.07.

Zeta

acciaio inox 18/10
stainless steel 18/10
cod. 116.05.

acciaio argentato
electro-plated stainless steel (EPSS)
cod. 116.07.





Impulso

acciaio inox 18/10
stainless steel 18/10
cod. 182.05.

acciaio argentato
electro-plated stainless steel (EPSS)
cod. 182.07.





Canto

acciaio inox 18/10
stainless steel 18/10
cod. 183.05.

acciaio argentato
electro-plated stainless steel (EPSS)
cod. 183.07.

Posate



Luce

acciaio inox 18/10
stainless steel 18/10
cod. 181.05.

acciaio argentato
electro-plated stainless steel (EPSS)
cod. 181.07.



Sedona

acciaio inox 18/10
stainless steel 18/10
cod. 111.05.

acciaio argentato
electro-plated stainless steel (EPSS)
cod. 111.07.

Posate

City

acciaio inox 18/10
stainless steel 18/10
cod. 122.05.

acciaio argentato
electro-plated stainless steel (EPSS)
cod. 122.07.





Rail

acciaio inox 18/10
stainless steel 18/10
cod. 114.05.

acciaio argentato
electro-plated stainless steel (EPSS)
cod. 114.07.

Posate



Gaia

acciaio inox 18/10
stainless steel 18/10
cod. 115.05.

acciaio argentato
electro-plated stainless steel (EPSS)
cod. 115.07.



Piano

*acciaio inox 18/10
stainless steel 18/10
cod. 109.05.*

*Acciaio argentato
electro-plated stainless steel (EPSS)
cod. 109.07.*

Posate



Sky

acciaio inox 18/10
stainless steel 18/10
cod. CE5.BR.05

Acciaio argentato
electro-plated stainless steel (EPSS)
cod. CE5.BR.07



Dakar

acciaio inox 18/10
stainless steel 18/10
cod. 194.05.

cod. 194.05.04.
acacia - acacia

cod. 194.05.09.
wengé - wengè







Kyoto

*Acciaio inox 18/10 - Stainless Steel 18/10
Manico in POM - POM handle
Finitura satinata - Satin finish*

cod. 192 05 14
nero - black

cod. 192 05 16
bianco - white



Branch Bastoncini - Chopsticks

Acciaio inox 18/10 - Stainless steel 18/10

cod. 118 05 00 082

acciaio argentato

electro-plated stainless steel (EPSS)

cod. 118 07 00 082

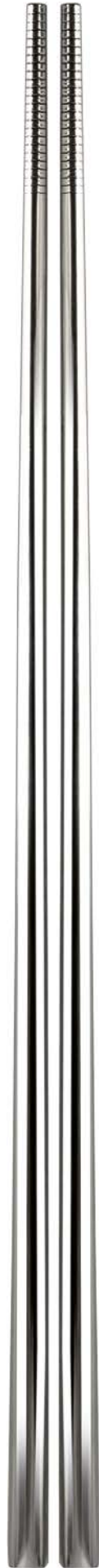



Kyoto Bastoncini - Chopsticks

Acciaio inox 18/10 - Stainless Steel 18/10

Manico in POM - POM handle

Finitura satinata - Satin finish

Set 2 pz - cod. 192 05 14 082
nero - black

Set 2 pz - cod. 192 05 16 082
bianco - white







Classic

Acciaio - 18/10 St. Steel



Metropolitan

acciaio inox 18/10
stainless steel 18/10
cod. 120.05.

acciaio argentato
electro-plated stainless steel (EPSS)
cod. 120.07.



Serbelloni

acciaio inox 18/10
stainless steel 18/10

cod. 010.05.

acciaio argentato
electro-plated stainless steel (EPSS)

cod. 010.07.



Medici

acciaio inox 18/10
stainless steel 18/10
cod. 110.05.

acciaio argentato
electro-plated stainless steel (EPSS)
cod. 110.07.





Rubans

acciaio inox 18/10
stainless steel 18/10
cod. 125.05.

acciaio argentato
electro-plated stainless steel (EPSS)
cod. 125.07.



900

acciaio inox 18/10
stainless steel 18/10
cod. CP 2CS.

acciaio argentato
electro-plated stainless steel (EPSS)
cod. CP 2CSA.

Posate



Rialto

acciaio inox 18/10
stainless steel 18/10
cod. 158.05.

acciaio argentato
electro-plated stainless steel (EPSS)
cod. 158.07.





Baguette

acciaio inox 18/10
stainless steel 18/10
cod. 164.05.

acciaio argentato
electro-plated stainless steel (EPSS)
cod. 164.07.



Royal

acciaio inox 18/10
stainless steel 18/10
cod. 143.05.

acciaio argentato
electro-plated stainless steel (EPSS)
cod. 143.07.





Decò

acciaio inox 18/10
stainless steel 18/10
cod. 126.05.

acciaio argentato
electro-plated stainless steel (EPSS)
cod. 126.07.



Evento

acciaio inox 18/10
stainless steel 18/10
cod. 132.05.

acciaio argentato
electro-plated stainless steel (EPSS)
cod. 132.07.



Palio

acciaio inox 18/10
stainless steel 18/10
cod. 165.05.

acciaio argentato
electro-plated stainless steel (EPSS)
cod. 165.07.





























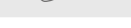

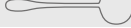





















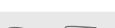
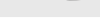

LUNGHEZZA POSATE (MM.)
CUTLERY LENGTH (MM.)

acciaio inox 18/10 - stainless steel 18/10
acciaio argentato - electro-plated stainless steel (EPSS)

TIPOLOGIA

Spessori

| | | |  |  |  |  |  |
|-------|---|---|---|---|---|---|---|
| | | | COD. 200 05 .. COD. 200 07 .. | COD. 117 05 .. COD. 117 07 .. | COD. 113 05 .. COD. 113 07 .. | COD. 116 05 .. COD. 116 07 .. | COD. 182 05 .. COD. 182 07 .. |
| | | | Mod. DUECENTO | Mod. 117 GUALTIERO MARCHESI | Mod. 113 STILETTO | Mod. 116 ZETA | Mod. 182 IMPULSO |
| | | | 5 mm | 8 mm | 5,5 mm | 5 mm | 5,5 mm |
| 001 | Cucchiaino tavola <i>Table spoon</i> |  | 210 | 216 | 210 | 210 | 207 |
| 002 | Forchetta tavola / Carne** <i>Table fork</i> |  | 210 | 215** | 205 | 210 | 207 |
| 003 | Cucchiaino brodo <i>Soup spoon</i> |  | 183 | 178 | 179 | 179 | 177 |
| 005 | Coltello tavola monoblocco <i>Table knife, solid handle</i> |  | | 236 | 235 | 240 | 235 |
| 009 | Coltello tavola manico cavo <i>Table knife, hollow handle</i> |  | 245 | | | | |
| 01009 | Coltello tavola m. cavo lama a spatola <i>Table knife, hollow handle with spatula-shaped blade</i> |  | | | | | |
| 011 | Cucchiaino frutta / Risotto** <i>Dessert spoon</i> |  | 185 | 200** | 187 | 189 | 192 |
| 012 | Forchetta frutta <i>Dessert fork</i> |  | 184 | 200 | 186 | 189 | 192 |
| 015 | Coltello frutta monoblocco <i>Dessert knife, solid handle</i> |  | | 220 | 211 | 216 | 218 |
| 019 | Coltello frutta manico cavo <i>Dessert knife, hollow handle</i> |  | 220 | | | | |
| 01019 | Coltello frutta m. cavo lama a spatola <i>Dessert knife, hollow handle with spatula-shaped blade</i> |  | | | | | |
| 021 | Cucchiaino the <i>Tea spoon</i> |  | 148 | 140 | 146 | 147 | 145 |
| 022 | Cucchiaino moka <i>Moka spoon</i> |  | 115 | 108 | 115 | 115 | 108 |
| 023 | Cucchiaino zucchero / Molla Individuale** <i>Sugar spoon</i> |  | | 225** | | | |
| 025 | Mestolo 130 ml - 4 oz <i>Soup ladle</i> |  | | | 306 | 300 | 305 |
| 026 | Forchetta servire <i>Serving fork</i> |  | 242 | | 241 | 241 | 245 |
| 027 | Cucchiaino servire <i>Serving spoon</i> |  | 241 | | 236 | 241 | 245 |
| 028 | Cucchiaino servire insalata <i>Salad serving spoon</i> |  | | | | | |
| 029 | Forchetta servire insalata <i>Salad serving fork</i> |  | | | | | |
| 031 | Forchetta pesce <i>Fish fork</i> |  | 185 | 215 | 182 | 189 | 185 |
| 032 | Coltello pesce <i>Fish knife</i> |  | 196 | 221 | 198 | 200 | 198 |
| 033 | Forchetta servire pesce <i>Fish serving fork</i> |  | | | | | |
| 034 | Coltello servire pesce <i>Fish serving knife</i> |  | | | | | |
| 035 | Cucchiaino bibita <i>Iced tea spoon</i> |  | | | | | |
| 037 | Paletta gelato <i>Ice cream spoon</i> |  | | | | | |
| 038 | Forchetta dolce <i>Cake fork</i> |  | 147 | 183 | 145 | 157 | 144 |
| 039 | Pala torta <i>Cake server</i> |  | | | 257 | 240 | 245 |
| 042 | Mestolino salsa 22 ml - 0,75 oz <i>Sauce ladle</i> |  | | | 158 | 159 | 165 |
| 043 | Coltello burro m. cavo <i>Butter knife, hollow handle</i> |  | 174 | | | | |
| 053 | Coltello burro monoblocco <i>Butter knife, solid handle</i> |  | | 170 | 165 | 170 | 175 |
| 055 | Coltello carne manico cavo <i>Steak knife, hollow handle</i> |  | | | | | |
| 059 | Coltello carne monoblocco <i>Steak knife, solid handle</i> |  | | 238 | | 225 | 225 |
| 061 | Coltello trinciare <i>Carving knife</i> |  | | | | | |
| 062 | Forchetta trinciare <i>Carving fork</i> |  | | | | | |
| 063 | Forchetta lumache <i>Snail fork</i> |  | | | | | |
| 064 | Forchetta ostriche <i>Oyster fork</i> |  | | | | | |
| 067 | Cucchiaino salsa <i>Gourmet spoon</i> |  | 185 | | 187 | 189 | 192 |
| 082 | Bastoncini <i>Chopsticks</i> |  | | | | | |
| 02002 | Forchetta spaghetti <i>Spaghetti fork</i> |  | | 215 | | | |
| 080 | Cucchiaino Lunch <i>Lunch spoon</i> |  | | | | | |

|  |  |  |  |  |  |  |  |  |
|---|---|---|---|---|---|---|---|---|
| COD. 183 05 .. COD. 183 07 .. | COD. 181 05 .. COD. 181 07 .. | COD. 111 05 COD. 111 07 | COD. 122 05 .. COD. 122 07 .. | COD. 114 05 .. COD. 114 07 .. | COD. 115 05 .. COD. 115 07 .. | COD. 109 05 .. COD. 109 07 .. | COD. CE5BR .. | COD. 192 05 14 COD.192 05 16 |
| Mod. 183 CANTO | Mod. 181 LUCE | Mod. SEDONA | Mod. 122 CITY | Mod. 114 RAIL | Mod. 115 GAIA | Mod. 109 PIANO | Mod. CE5BR SKY | Mod. KYOTO |
| 3 mm | 4,5 mm | 5,5 mm | 4 mm | 3 mm | 4 mm | 3 mm | 3,5 mm | |
| 205 | 206 | 207 | 196 | 206 | 222 | 209 | 207 | 211 |
| 203 | 205 | 205 | 199 | 206 | 226 | 210 | 207 | 211 |
| 172 | 181 | 175 | 173 | 175 | | 180 | | |
| 235 | 225 | 237 | 241 | 235 | 251 | 233 | 231 | 237 |
| | | | 243 | | | | | |
| 185 | 183 | 190 | 176 | 185 | 202 | 185 | 186 | 191 |
| 185 | 184 | 193 | 178 | 185 | 203 | 187 | 186 | 193 |
| 211 | 204 | 218 | 220 | 211 | 230 | 210 | 209 | 211 |
| | | | 220 | | | | | |
| 143 | 149 | 143 | 133 | 144 | 150 | 136 | 145 | 148 |
| 114 | 108 | 108 | 104 | 133 | 119 | 110 | 114 | 112 |
| | | | 120 | | | | | |
| | 298 | | 307 | 304 | 297 | 307 | 306 | |
| 237 | 237 | 242 | 230 | 237 | 248 | 230 | 237 | |
| 236 | 242 | 244 | 227 | 237 | 245 | 227 | 234 | |
| | | | 227 | | | | | |
| | | | 227 | | | | | |
| 195 | 185 | 184 | 199 | 185 | 201 | 200 | | |
| 206 | 204 | 204 | 211 | 209 | 227 | 214 | 215 | |
| | | | | | | | | |
| | | | 195 | | | | | |
| | | | 131 | | | | | |
| 145 | 155 | 144 | 143 | 146 | 165 | 144 | 150 | 149 |
| 339 | 245 | 265 | 240 | 262 | 270 | 243 | 250 | |
| 160 | 165 | 165 | 160 | 165 | 170 | 160 | | |
| | | | | | | | | |
| 175 | 175 | 172 | 166 | 165 | | 177 | 175 | 150 |
| | | | | | | | | |
| 235 | 225 | | 223 | | | 232 | | |
| | | | | | | | | |
| | | | | | | | | |
| 185 | 183 | 190 | 176 | 185 | 202 | 185 | | |
| | | | | | | | | 227 |
| | | 160 | | | | | | |

















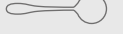



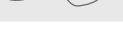









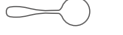



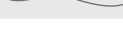













LUNGHEZZA POSATE (MM.)
CUTLERY LENGTH (MM.)

acciaio inox 18/10 - stainless steel 18/10
acciaio argentato - electro-plated stainless steel (EPSS)

TIPOLOGIA

Spessori

| | |  |  |  |  |  |
|-------|--|---|---|---|---|---|
| | | COD. 194 05 04 .. | COD. 194 05 09 .. | COD. 120 05 .. COD. 120 07 .. COD. 055 .. | COD. 010 05 .. COD. 010 07 .. | COD. 110 05 .. COD. 110 07 .. |
| | | Mod. 194 DAKAR ACACIA | Mod. 194 DAKAR WENGÉ | Mod. 120 METROPOLITAN | Mod. 010 SERBELLONI | Mod. 110 MEDICI |
| | | | | 5 mm | 3 mm | 3 mm |
| 001 | Cucchiaino tavola Table spoon  | 205 | 205 | 202 | 207 | 207 |
| 002 | Forchetta tavola Table fork  | 207 | 207 | 201 | 205 | 205 |
| 003 | Cucchiaino brodo Soup spoon  | | | 179 | 175 | 175 |
| 005 | Coltello tavola monoblocco Table knife, solid handle  | | | 230 | 237 | 237 |
| 009 | Coltello tavola manico cavo Table knife, hollow handle  | 230 | 230 | 236 | 239 | 239 |
| 01009 | Coltello tavola m. cavo lama a spatola Table knife, hollow handle with spatula-shaped blade  | | | | | |
| 011 | Cucchiaino frutta Dessert spoon  | 199 | 199 | 182 | 186 | 186 |
| 012 | Forchetta frutta Dessert fork  | 197 | 197 | 182 | 187 | 187 |
| 015 | Coltello frutta monoblocco Dessert knife, solid handle  | | | 207 | 215 | 215 |
| 019 | Coltello frutta manico cavo Dessert knife, hollow handle  | 218 | 218 | 207 | 215 | 215 |
| 01019 | Coltello frutta m. cavo lama a spatola Dessert knife, hollow handle with spatula-shaped blade  | | | | | |
| 021 | Cucchiaino the Tea spoon  | 149 | 149 | 142 | 141 | 141 |
| 022 | Cucchiaino moka Moka spoon  | 134 | 134 | 106 | 118 | 118 |
| 023 | Cucchiaino zucchero Sugar spoon  | | | 130 | | |
| 025 | Mestolo 130 ml - 4 oz Soup ladle  | 224 | 224 | 322 | 296 | 296 |
| 026 | Forchetta servire Serving fork  | 219 | 219 | 262 | 227 | 227 |
| 027 | Cucchiaino servire Serving spoon  | 219 | 219 | 259 | 225 | 225 |
| 028 | Cucchiaino servire insalata Salad serving spoon  | | | | 225 | 225 |
| 029 | Forchetta servire insalata Salad serving fork  | | | | 225 | 225 |
| 031 | Forchetta pesce Fish fork  | | | 201 | 182 | 182 |
| 032 | Coltello pesce Fish knife  | | | 217 | 202 | 202 |
| 033 | Forchetta servire pesce Fish serving fork  | | | | 245 | 245 |
| 034 | Coltello servire pesce Fish serving knife  | | | | 267 | 267 |
| 035 | Cucchiaino bibita Iced tea spoon  | | | 207 | | 208 |
| 037 | Paletta gelato Ice cream spoon  | | | | 140 | 140 |
| 038 | Forchetta dolce Cake fork  | 151 | 151 | 147 | 152 | 152 |
| 039 | Pala torta Cake server  | 244 | 244 | 256 | 242 | 242 |
| 042 | Mestolino salsa 22 ml - 0,75 oz Sauce ladle  | | | 172 | 158 | 158 |
| 043 | Coltello burro m. cavo Butter knife, hollow handle  | | | 160 | 163 | 163 |
| 053 | Coltello burro monoblocco Butter knife, solid handle  | | | 170 | 171 | 171 |
| 055 | Coltello carne manico cavo Steak knife, hollow handle  | | | 222 | 216 | 216 |
| 059 | Coltello carne monoblocco Steak knife, solid handle  | | | | 225 | 225 |
| 063 | Forchetta lumache Snail fork  | | | | | |
| 064 | Forchetta ostriche Oyster fork  | | | | | |
| 067 | Cucchiaino salsa Gourmet spoon  | | | 182 | 186 | 186 |
| 080 | Cucchiaino Lunch Lunch spoon  | | | | | |

|  |  |  |  |  |  |  |  |
|---|---|---|---|---|---|---|---|
| COD. 125 05 .. COD. 125 07 .. | COD. CP2CS COD. CP2CSA | COD. 158 05 .. COD. 158 07 .. | COD. 164 05 .. COD. 164 07 .. | COD. 143 05 .. COD. 143 07 .. | COD. 126 05 .. COD. 126 07 .. | COD. 132 05 .. COD. 132 07 .. | COD. 165 05 .. COD. 165 07 .. |
| Mod. 125 RUBANS | Mod. CP2 900 | Mod. 158 RIALTO | Mod. 164 BAGUETTE | Mod. 143 ROYAL | Mod. 126 DECO' | Mod. 132 EVENTO | Mod. 165 PALIO |
| 3 mm | 3 mm | 3,5 mm | 3 mm | 3 mm | 3 mm | 3 mm | 3 mm |
| 206 | 205 | 203 | 204 | 203 | 203 | 203 | 203 |
| 208 | 207 | 205 | 204 | 205 | 203 | 208 | 204 |
| 172 | 178 | 178 | 169 | 173 | 173 | | 168 |
| 235 | 234 | 235 | 247 | 226 | 228 | 226 | 237 |
| 242 | | 242 | 243 | 234 | 244 | | 243 |
| | | | 238 | | | | |
| 185 | 185 | 180 | 178 | 179 | 182 | 172 | 178 |
| 187 | 186 | 180 | 180 | 179 | 182 | 178 | 178 |
| 212 | 216 | 212 | 214 | 205 | 205 | 202 | 215 |
| 218 | | 219 | 219 | 216 | 219 | | 219 |
| | | | 216 | | | | |
| 138 | 143 | 143 | 143 | 143 | 139 | 132 | 142 |
| 109 | 106 | 112 | 112 | 112 | 109 | 115 | 112 |
| | | | | | 122 | | |
| 310 | 300 | 300 | 298 | 295 | 308 | 306 | 292 |
| 238 | 242 | 240 | 238 | 240 | 233 | 234 | 240 |
| 236 | 237 | 236 | 236 | 236 | 233 | 227 | 236 |
| | | | | | | | |
| | | | | | | | |
| 184 | 184 | 181 | 204 | 205 | 180 | 178 | 205 |
| 209 | 217 | 185 | 208 | 209 | 200 | 194 | 209 |
| | | | | | | | 230 |
| | | | | | | | 250 |
| 192 | 192 | 206 | 206 | 193 | 208 | | 207 |
| | | 133 | 133 | 133 | | | 133 |
| 144 | 149 | 153 | 153 | 153 | 146 | 148 | 153 |
| 245 | 262 | 237 | 238 | 237 | 242 | 235 | 237 |
| 154 | 164 | 152 | 164 | 158 | 150 | 145 | 147 |
| 160 | | 160 | 160 | 164 | | | 160 |
| 171 | 170 | 172 | 166 | 171 | 196 | 166 | 166 |
| 210 | | 215 | 223 | 217 | 220 | | 223 |
| | | | 212 | | | 212 | 212 |
| | | | | | | | 156 |
| | | | | | | | 155 |
| 185 | | 180 | 178 | 179 | 182 | 172 | 178 |

Better known as EPNS, it is a precious alloy of copper, zinc and nickel. The high concentration of nickel present in the alloy used by Broggi 1818 improves its mechanical features and endurance. The galvanisation process permits depositing pure silver at 999,99% with high thicknesses and so this alloy can have almost unlimited uses. Due to its nature, EPNS has features and behaviour very similar to solid silver. In fact, specific weight, malleability, thermal conductivity, warm colour, and pleasing aging are all features of a noble metal.

Mieux connue comme EPNS (Electro Plated Nickel Silver), il s'agit d'un alliage de qualité de cuivre, zinc et nickel. La haute concentration de nickel présent dans l'alliage utilisé par Broggi 1818 en améliore les caractéristiques mécaniques et la résistance. Le procès de galvanisation permet de déposer de l'argent pur à 999,99% avec des épaisseurs élevées qui en consent l'utilisation presque illimitée. Le maillechort, par sa nature, a des caractéristiques et des comportements très semblables à l'argent massif. En effet, poids spécifique, malléabilité, conductibilité thermique, couleur chaude, vieillissement agréable, sont toutes des caractéristiques d'un métal noble.

Mejor conocida como EPNS (Electro Plated Nickel Silver), se trata de una aleación preciada de cobre, zinc y níquel: la elevada concentración de níquel presente en la aleación utilizada por Broggi 1818 mejora sus características mecánicas y la resistencia. El proceso de galvanización permite depositar plata pura al 999,99% con espesores elevados que permiten un empleo prácticamente ilimitado. La alpaca, por su naturaleza, tiene características y comportamientos muy similares a los de la plata maciza. De hecho, el peso específico, la maleabilidad, conductibilidad térmica, color cálido, agradable envejecimiento, son todas características de metal noble.

Besser bekannt unter der Bezeichnung EPNS (Electro Plated Nickel Silver), handelt es sich um eine wertvolle Legierung aus Kupfer, Zink und Nickel. Der hier von Broggi 1818 eingesetzte Nickelanteil verbessert wesentlich die mechanischen Merkmale und die Widerstandsfähigkeit der Legierung. Der Galvanisierungsprozess ermöglicht die hochgradige Ablagerung von Reinsilber zu 999,99%, womit praktisch ein unbeschränkter Einsatz des verarbeiteten Artikels gewährleistet ist. Alpaka oder Neusilber hat von Natur her Eigenschaften und "Verhaltensweisen", die schwerem Silber sehr ähnlich sind. Eigengewicht, Verformbarkeit, Wärmeleitung, der warme Farbton und hervorragende Alterung machen es zu einem echten Edelmetall.

Posateria

Alpacca Argentata

Cutlery - Electro - Plated Nickel Silver
Couverts - Maillechort argenté
Cubiertos - Alpaca plateada
Besteck - Alpacca versilbert

Meglio conosciuta come EPNS (Electro Plated Nickel Silver), si tratta di una lega pregiata di rame, zinco e nichel. L'alta concentrazione di nichel presente nella lega utilizzata da Broggi 1818 ne migliora le caratteristiche meccaniche e la resistenza. Il processo di galvanizzazione permette di depositare argento puro al 999,99% con spessori elevati che ne consente l'utilizzo pressoché illimitato. L'alpacca, per sua natura, ha caratteristiche e comportamenti molto simili all'argento massiccio. Infatti, peso specifico, malleabilità, conducibilità termica, colore caldo, invecchiamento gradevole, sono tutte caratteristiche da metallo nobile.





Classic
Alpacca - EPNS

Alpacca Argentata



Beatrice

alpacca super argentata
electro-plated nickel silver (EPNS)
cod. 103...



Ciga

alpacca super argentata
electro-plated nickel silver (EPNS)
cod. 067...

Alpacca Argentata



Visconti

alpacca super argentata
electro-plated nickel silver (EPNS)
cod. 031...



Alpacca Argentata



Serbelloni

alpaca super argentata
electro-plated nickel silver (EPNS)
cod. 010...



Belgioioso
alpacca super argentata
electro-plated nickel silver (EPNS)
cod. 005...

Alpacca Argentata



Castiglione

alpacca super argentata
electro-plated nickel silver (EPNS)
cod. 016...



Alpacca Argentata



Borroneo

alpacca super argentata
electro-plated nickel silver (EPNS)
cod. 008...



Sforza

alpacca super argentata
electro-plated nickel silver (EPNS)
cod. 068...

Alpacca Argentata



Liberty

alpacca super argentata
electro-plated nickel silver (EPNS)
cod. 020...



Sormani

alpacca super argentata
electro-plated nickel silver (EPNS)
cod. 063...

Alpacca Argentata



Bernini

alpacca super argentata
electro-plated nickel silver (EPNS)
cod. 011...



Excelsior

alpacca super argentata
electro-plated nickel silver (EPNS)
cod. 075...

Complementi



.065 Apribottiglie

Bottle opener
Décapsuleur
Abrebotellas
Flaschenöffner



.028 Cucchiaio servire insalata, aderenza metacrilato

Salad serving spoon, acrylic head
Cuillère à servir salade, cuilleron acrylique
Cucharón servir ensalada, cabeza acrílica
Serviersalatlöffel



.445 Cucchiaio tapas

Tapas spoon
Cuillère à tapas
Cuchara tapas
Tapas - Löffel



.040 Pala torta seghettata

Cake server, serrated edge
Pelle à tarte, dentellé
Pala tarta dentada
Tortenschaufel



.140 Coltello panettone

Cake knife
Couteau à pain
Cuchillo pan
Brotmesser



.061 Coltello trinciare

Carving knife
Couteau à découper
Cuchillo de trinchar
Tranchiermesser



.062 Forchetta trinciare

Carving fork
Fourchette à découper
Tenedor de trinchar
Tranchiergabel



**.029 Forchetta servire insalata
aderenza metacrilato**

Salad serving fork, acrylic head
Fourchette à servir salade, tête acrylique
Tenedor servir ensalada, cabeza acrílica
Serviersalatgabel



.056 Coltello formaggio duro a due punte

Hard cheese knife, two-prong
Couteau à fromage à pâte dure, deux dents
Cuchillo queso de pasta dura, dos puntas
Hartkäsemesser mit 2 Spitzen



.057 Coltello formaggio a pasta molle

Soft cheese knife
Couteau à fromage à pâte molle
Cuchillo queso de pasta blanda
Weichkäsemesser



.085 Schiaccianoci

Nutcracker
Casse-noix
Cascanueces
Nußnacker



.125 Pinza champagne

Champagne pliers
Pince à champagne
Pinzas para champán
Champagnerzange



LUNGHEZZA POSATE (MM.)
CUTLERY LENGTH (MM.)







alpacca argentata
electro-plated nickel silver (EPNS)



COD. 103 00 .. COD. 067 00 .. COD. 031 00 .. COD. 010 00 .. COD. 005 00 ..

TIPOLOGIA

| | | Mod. 103 BEATRICE | Mod. 67 CIGA | Mod. 31 VISCONTI | Mod. 10/R SERBELLONI | Mod. 05 BELGIOIOSO |
|-----|---|------------------------------|-------------------------|-----------------------------|---------------------------------|-------------------------------|
| 001 | Cucchiaino tavola Table spoon | 211 | 212 | 216 | 203 | 212 |
| 002 | Forchetta tavola Table fork | 215 | 217 | 219 | 204 | 215 |
| 003 | Cucchiaino brodo Soup spoon | | 180 | 178 | | |
| 009 | Coltello tavola manico cavo Table knife, hollow handle | 246 | 240 | 246 | 239 | 252 |
| 011 | Cucchiaino frutta Dessert spoon | 184 | 190 | 188 | 188 | 184 |
| 012 | Forchetta frutta Dessert fork | 182 | 186 | 190 | 188 | 185 |
| 019 | Coltello frutta manico cavo Dessert knife, hollow handle | 217 | 212 | 219 | 215 | 211 |
| 021 | Cucchiaino the Tea spoon | 137 | 147 | 143 | 145 | 143 |
| 022 | Cucchiaino moka Moka spoon | 103 | 119 | 119 | 119 | 115 |
| 025 | Mestolo 130 ml - 4 oz Soup ladle | | 287 | 315 | 305 | 295 |
| 026 | Forchetta servire Serving fork | | 244 | 267 | 244 | 245 |
| 027 | Cucchiaino servire Serving spoon | | 246 | 278 | 245 | 247 |
| 028 | Cucchiaino servire insalata Salad serving spoon | | 242 | 240 | 226 | 237 |
| 029 | Forchetta servire insalata Salad serving fork | | 242 | 240 | 228 | 237 |
| 031 | Forchetta pesce Fish fork | | 199 | 198 | 197 | 193 |
| 032 | Coltello pesce Fish knife | | 229 | 229 | 230 | 225 |
| 033 | Forchetta servire pesce Fish serving fork | | 246 | 251 | 238 | 246 |
| 034 | Coltello servire pesce Fish serving knife | | 279 | 276 | 274 | 279 |
| 035 | Cucchiaino bibita Iced tea spoon | | | | | 178 |
| 037 | Paletta gelato Ice cream spoon | | 143 | 141 | 144 | 141 |
| 038 | Forchetta dolce Cake fork | | 163 | 157 | 162 | 162 |
| 039 | Pala torta Cake server | | 269 | 273 | 265 | 270 |
| 042 | Mestolino salsa 22 ml - 0,75 oz Sauce ladle | | 160 | 162 | 160 | 159 |
| 043 | Coltello burro manico cavo Butter knife, hollow handle | 169 | 164 | 168 | 163 | 157 |
| 055 | Coltello carne manico cavo Steak knife, hollow handle | 209 | 213 | 217 | 216 | 208 |
| 061 | Coltello trinciare Carving knife | | 313 | 318 | 311 | 310 |
| 062 | Forchetta trinciare Carving fork | | 265 | 272 | 257 | 260 |
| 063 | Forchetta lumache Snail fork | | | | | 132 |
| 064 | Forchetta ostriche Oyster fork | | | | | |
| 067 | Cucchiaino salsa Gourmet spoon | 184 | 190 | 188 | 188 | 184 |

|  |  |  |  |  |  |  |
|--|--|--|--|---|--|--|
| COD. 016 00 .. | COD. 008 00 .. | COD. 068 00 .. | COD. 020 00 .. | COD. 063... | COD. 011 00 .. | COD. 075 00 .. |
| Mod. 16 CASTIGLIONE | Mod. 08 BORROMEO | Mod. 68 SFORZA | Mod. 20 LIBERTY | Mod. 63 SORMANI | Mod. 11 BERNINI | Mod. 74 EXCELSIOR |
| 204 | 212 | 207 | 207 | 202 | 212 | 215 |
| 208 | 215 | 211 | 215 | 204 | 215 | 220 |
| | | 174 | | | | |
| 242 | 259 | 241 | 240 | 235 | 242 | 254 |
| 178 | 182 | 184 | 187 | 171 | 182 | 186 |
| 178 | 185 | 181 | 190 | 173 | 182 | 193 |
| 209 | 220 | 210 | 210 | 210 | 215 | 227 |
| 140 | 142 | 143 | 142 | 134 | 142 | 149 |
| 115 | 118 | 106 | 117 | 104 | 106 | 105 |
| 320 | 303 | 280 | 297 | 275 | 291 | 295 |
| 243 | 243 | 237 | 244 | 224 | 263 | 261 |
| 245 | 243 | 240 | 244 | 222 | 269 | 261 |
| 241 | 245 | 243 | 241 | 230 | 245 | |
| 241 | 245 | 243 | 241 | 230 | 245 | |
| 188 | 193 | 195 | 196 | 172 | 194 | 195 |
| 222 | 225 | 223 | 222 | 198 | 224 | 228 |
| 245 | 246 | 238 | 237 | 235 | 240 | |
| 279 | 276 | 272 | 274 | 265 | 279 | |
| | | | | | | |
| 140 | 140 | 138 | 144 | 131 | 137 | 145 |
| 158 | 159 | 158 | 156 | 150 | 153 | |
| 265 | 270 | 262 | 266 | 250 | 265 | |
| 152 | 155 | 156 | 161 | 138 | 156 | 202 |
| 160 | 168 | 159 | 159 | 153 | 164 | 162 |
| 222 | 215 | 207 | 209 | 205 | 214 | 214 |
| 309 | 316 | 310 | 285 | 304 | 308 | |
| 260 | 265 | 265 | 265 | 250 | 268 | |
| | | | | | | |
| | | | | | | |
| 178 | 182 | 184 | 187 | 204 | 182 | 186 |

Vantiamo un patrimonio esclusivo tra marchi, stemmi, incisioni e fregi grazie alla nostra capacità di studiare insieme al cliente una soluzione unica, che permetta al proprio locale di emergere. Questa nostra peculiarità, ormai molto rara, è la capacità di offrire un servizio completo al cliente tramite la personalizzazione dei propri prodotti.

Sono cinque i diversi sistemi di personalizzazione:

Incisione del logo

L'incisione del logo o del nome del cliente avviene per scalfittura, senza asportazione di materiale mediante specifici pantografi dotati di punta di diamante o, in alternativa, con incisione laser.

Punzonatura dello stemma

Per la punzonatura dello stemma vengono eseguiti punzoni e relativi controstampi, in modo da poter imprimere nel pezzo, mediante apposite macchine punzonatrici, il logo richiesto dal cliente.

Applicazione a rilievo

L'applicazione degli stemmi viene eseguita mediante saldobrasatura. Sono previste diverse tipologie di loghi che si differenziano sia per i materiali impiegati sia per le dimensioni. Tali differenziazioni variano in funzione dei pezzi su cui verranno applicati i loghi stessi.

Personalizzazione dei componenti

Nel caso di pezzi di vasellame, quando i lotti sono significanti, le personalizzazioni possono essere eseguite anche sostituendo alcuni componenti previsti con altrettanti componenti personalizzati. Facendo qualche esempio: nel caso di un vassoio possono essere sostituite le maniglie, per i sottopiatte possono essere cambiate le bordure, oppure per le caffettiere possono essere modificati i manici, i pomoli o i beccucci.

Studio e realizzazione di nuovi prodotti

In base ad esigenze specifiche del cliente, possono essere studiati e sviluppati nuovi articoli che assolvano integralmente il problema richiesto. Possono essere inoltre eseguite modifiche parziali o sostanziali degli articoli esistenti ed anche finiture superficiali diverse come satinature, dorature, bruniture, ecc.

Un altro servizio esclusivo

che Broggi riserva ai suoi clienti è la rimessa a nuovo di prodotti storici in alpacca, attraverso una serie di lavorazioni quali ribaditura delle superfici, sgrassato, riargentatura, rinvivatura, sostituzione dei eventuali componenti danneggiati.

We are proud of our exclusive assets of hallmarks, logos, engravings and ornamentations thanks to our ability to analyse and find, together with the client, a unique solution to make him stand out in the market. Our distinguishing trait is the ability to offer our clients a comprehensive customised product service, something quite strange for a manufacturing company.

There are five different customisation systems:

Logo engraving

The client's logo or name is engraved by scuffing- a chipless process-, using special diamond-tipped pantographs or, alternatively, laser engravers

Logo punching

Hallmarks and relevant matching dies are used to punch logos so that the logo the client wants can be stamped on the piece using special punching presses.

Embossing

Logos are blaze-welded.

There are several types of logos that are different due to the materials used or to their dimensions.

Such differences vary depending on the pieces on which the logos are to be applied.

Component customisation

Tableware items, when the batches are important, can be also personalised by replacing some regular components with other similar customised components.

For instance, you can change the handles in a tray, can have different borders in service plates, or handles, knobs and spouts in coffee pots.

Design and production of new products

Based on a client's specific requirements and needs, we can design and develop new items so as to fully satisfy such requirements. We can also introduce partial modifications or make major changes to already existing items as well as use different surface finishes such as satin, gilding, polishing and so on.

Repair and maintenance

Another exclusive service Broggi offer their clients is the restoration of antique nickel silver items by means of a series of machining processes such as surface riveting, degreasing, re-silver plating, facing and replacing of any damaged components.

Personalizzazioni

Customisation



The vastly wide range of Broggi 1818 complements is

the natural completion to the cutlery that we create. Suitable for specific or refined employments, some of them, as for instance the truffle cutter or the lobster cracker, come from the story and from the bicentenary tradition of craftsmanship of exclusive objects that belong to us; others, like the chopsticks or the appetizer spoons, are tools developed in recent times, in response to the needs and to the contemporary uses and are meant with the purpose of satisfying even the most special requirement of our clients.

La vaste gamme des accessoires Broggi 1818 est la

intégration naturelle aux couverts que nous créons. Aptés à l'usage pour utilisations spécifiques ou raffinés, certains d'entre eux, comme par exemple le coupe-truffes et la pince à homard, descendent de l'histoire et de la tradition bicentenaire de la production artisanale d'objets exclusifs qui nous appartient; autres, et cela est le cas des baguettes chinoises ou des cuillères de mise en bouche, sont outils développés dans les temps récents, répondent aux nécessités des emplois contemporains et naissent en vue de satisfaire même l'exigence la plus particulière des nos clients.

La amplísima gama de los accesorios Broggi 1818 es

la natural integración a la cubertería que creamos. Aptos para la utilización para usos específicos o refinados, algunos de estos, como por ejemplo el cortatrufas y las pinzas langostas, descendien de la historia y de la bicentenaria tradición de producción artesanal de objetos exclusivos que nos pertenece; otros, como los palillos chinos o las cucharas aperitivo, son utensilios desarrollados en los tiempos recientes, responden a las necesidades de los usos contemporáneos y nacen con el objetivo de satisfacer incluso la exigencia más especial de nuestros clientes.

Die breite Produktpalette von Broggi 1818 Zubehör

ist die natürliche Integration in unsere Besteck. Einige von ihnen, wie der Trüffelschneider und die Krustentierzange, sind für bestimmte oder raffinierte Zwecke geeignet und stammen von unserer Geschichte und zweihundertjährigen Tradition der handwerklichen Herstellung exklusiver Objekte ab. Andere, wie Essstäbchen oder Vorspeisen, sind Werkzeuge, die in jüngster Zeit entwickelt wurden. Sie reagieren auf aktuelle Bedürfnisse und Verwendungszwecke und sind geboren mit dem Ziel alle besonderen Bedürfnisse unserer Kunden zu befriedigen.

Complementi

Acciaio

Accessories - St. Steel
Accessoires - Acier Inox
Accesorios - Acero Inox
Küchenzubehör - Edelstahl

La vastissima gamma dei complementi Broggi 1818 è

la naturale integrazione alla posateria che creiamo. Atti all'utilizzo per usi specifici o raffinati, alcuni di essi, come ad esempio il tagliatartufi e le pinze aragosta, discendono dalla storia e dalla bicentenaria tradizione di produzione artigiana di oggetti esclusivi che ci appartengono; altri, e questo è il caso dei chopsticks o degli appetizers, sono utensili sviluppati nei tempi recenti, rispondono alle necessità agli usi contemporanei e nascono nell'ottica di soddisfare anche la più speciale esigenza dei nostri clienti.

Complementi

Coltello carne Marchesi acciaio

Marchesi steak knife, stainless steel
Couteau à viande Marchesi en acier inoxydable
Cuchillo carne Marchesi en acero inoxidable
Filetmesser Marchesi, Edelstahl rostfrei

| | Cm | In. |
|---------------|------|-------|
| 117 05 01 059 | 23,8 | 9,1/2 |

Lama liscia - Smooth blade

| | | |
|---------------|------|-------|
| 117 05 02 059 | 23,8 | 9,1/2 |
|---------------|------|-------|

Lama seghettata - Serrated blade



Coltello carne monoblocco

Steak knife, solid handle
Couteau à viande, monobloc
Cuchillo carne, monobloc
Filetmesser Monoblock

| | Cm | In. |
|---------------|----|-------|
| 009 05 00 059 | 21 | 8,1/4 |



Coltello carne fiorentina in acciaio inossidabile

Fiorentina steak knife, stainless steel
Couteau à viande Fiorentina en acier inoxydable
Cuchillo carne Fiorentina en acero inoxidable
Filetmesser Fiorentina, Edelstahl rostfrei

| | Cm | In. |
|---------------|----|-----|
| 305 05 91 814 | 23 | 9 |



Coltello pizza Palio

Pizza knife
Couteau à pizza
Cuchillo pizza
Pizzamesser

| | Cm | In. |
|---------------|----|-------|
| 305 05 91 815 | 21 | 8,1/4 |



Coltello carne Angus in acciaio inossidabile

Angus steak knife, stainless steel
Couteau à viande Angus en acier inoxydable
Cuchillo carne Angus en acero inoxidable
Filetmesser Angus, Edelstahl rostfrei

| | Cm | In. |
|---------------|----|-----|
| 305 05 91 816 | 23 | 9 |





Coltello carne Java

*Java steak knife
Couteau à viande Java
Cuchillo carne Java
Java Fleischmesser*

| | Cm | In. |
|----------------------------|------|-------|
| 305 05 91 797 | 22,5 | 8,7/8 |
| Manico nero - Black handle | | |

| | Cm | In. |
|------------------------------|------|-------|
| 305 45 91 797 | 22,5 | 8,7/8 |
| Manico avorio - Ivory handle | | |

Complementi

Stiletto crostacei

Oyster pick
Curette à crustacés
Tenedor mariscos
Auster / Krustazeengabel

| | Cm | In. |
|--------|------|-------|
| CPA 64 | 22,7 | 8,7/8 |



Stiletto aragosta

Lobster pick
Fourchette à homard
Tenedor langosta
Langustegabel

| | Cm | In. |
|---------------|------|-------|
| 903 05 84 659 | 20,2 | 7,7/8 |



Pinza aragosta

Lobster cracker
Pince à homard
Pinzas langostas
Langustezange

| | Cm | In. |
|---------------|------|-------|
| 305 05 91 658 | 22,5 | 8,7/8 |



Rompinoci

Nutcracker
Casse-noix
Cascanueces
Nußnacker

| | Cm | In. |
|---------------|----|-------|
| 903 05 84 163 | 22 | 8,5/8 |



Molla lumache

Snail tong
Pince à escargots
Pinzas caracoles
Schneckenzange

| | Cm | In. |
|---------------|----|-------|
| 305 05 81 549 | 16 | 6,1/4 |



Forchettina lumache Palio

Palio snail fork
Fourchette à escargots Palio
Tenedor caracoles Palio
Palio Schnecken-gabel

| | Cm | In. |
|---------------|------|-------|
| 165 05 00 063 | 15,6 | 6,1/8 |



Forchettina ostriche Palio

Palio oyster fork
Fourchette à huîtres Palio
Tenedor ostras Palio
Palio Austern-gabel

| | Cm | In. |
|---------------|------|-------|
| 165 05 00 064 | 15,6 | 6,1/8 |



Appetizer tondo, cucchiaio

Appetizer curved spoon
Cuillère de mise en bouche ronde pliée
Cuchara aperitivo redonda plegada
Appetizer - rund gebogener Löffel

| | Cm | In. |
|---------------|----|-------|
| 305 05 81 696 | 14 | 5,1/2 |



Appetizer con piega, cucchiaio

Bended appetizer, spoon
Cuillère de mise en bouche pliée
Cuchara aperitivo plegada
Appetizer Löffel

| | Cm | In. |
|--------------|----|-------|
| 165 05 00175 | 14 | 5,1/2 |



Appetizer con riccio, cucchiaio

Curled appetizer, spoon
Cuillère de mise en bouche en boucle
Aperitivo con nudo, cuchara
Appetizer Löffel

| | Cm | In. |
|---------------|----|-------|
| 165 05 00 174 | 14 | 5,1/2 |



Cucchiaino tapas

Tapas spoon
Cuillère a tapas
Cuchara tapas
Tapas Löffel

| | Cm | In. |
|--------|----|------|
| CF1 TA | 17 | 6,34 |

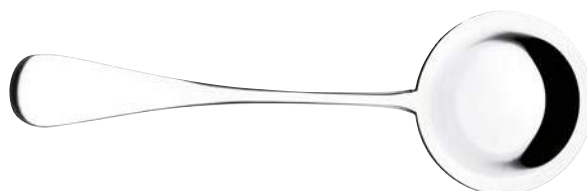

Raccoglibriciole

Crumb scraper
Ramasse-miettes
Recogemigas
Krümelsammler

| | Cm | In. |
|---------------|----|-----|
| 903 05 91 939 | 15 | 6 |



Complementi



Molla multiuso

Multipurpose tongs
Pince à servir
Pinzas para servir
Universalzangen

| | Cm | In. |
|---------------|------|--------|
| 903 05 81 MMU | 29,5 | 11,5/8 |



Molla pasta

Pasta tongs
Pince à pâtes
Pinzas para pasta
Pastazangen

| | Cm | In. |
|---------------|----|--------|
| 903 05 81 MPA | 27 | 10,5/8 |



Molla insalata

Salad tongs
Pince à salade
Pinzas ensalada
Salatzangen

| | Cm | In. |
|---------------|----|--------|
| 903 05 81 MIN | 27 | 10,5/8 |



Molla universal

Universal tongs
Pince universal
Pinzas universal
Zangen, Universal

| | Cm | In. |
|---------------|----|--------|
| 903 05 81 MUN | 27 | 10,5/8 |



Molla arrosto

Roast tongs
Pince à rôti
Pinzas asado
Fleischzangen

| | Cm | In. |
|---------------|----|-------|
| 903 05 81 MAR | 25 | 8,7/8 |



Molla dolci

Cake tongs
Pince à gâteaux
Pinzas postre
Gebäckzangen

| | Cm | In. |
|---------------|----|-------|
| 903 05 81 MDO | 25 | 8,7/8 |



Molla ghiaccio

Ice tongs
Pince à glaçons
Pinzas hielo
Eiszangen

| | Cm | In. |
|---------------|----|-------|
| 903 05 81 MGH | 20 | 7,7/8 |



Molla spaghetti

Spaghetti tongs
Pince à spaghetti
Pinzas espaguetis
Spaghettizangen

| | Cm | In. |
|---------------|----|-------|
| 903 05 81 MSP | 25 | 8,7/8 |

Complementi

Molla per antipasti

Hors d'oeuvre tong
Pince à hors d'oeuvre
Pinzas entremeses
Vorspeisenzange

| | Cm | In. |
|---------------|------|-------|
| 305 05 81 544 | 19,5 | 7,5/8 |



Molla zucchero / ghiaccio

Ice / sugar tong
Pince à sucre / glace
Pinzas azúcar / hielo
Zucker / Eiszange

| | Cm | In. |
|---------------|------|-----|
| 305 05 81 545 | 12,5 | 5 |
| 305 05 81 538 | 18 | 7 |



Molla per pasticceria / pane

Pastry / bread tong
Pince à gâteau / pain
Pinzas pasteles / pan
Gebäck / brotzange

| | Cm | In. |
|---------------|----|-----|
| 305 05 81 539 | 18 | 7 |
| 305 05 81 540 | 23 | 9 |



Molla forbice per pasticceria

Pastry scissors tong
Pince ciseaux gâteau
Pinzas tijeras pasteles
Gebäckzange

| | Cm | In. |
|---------------|----|-------|
| 305 05 81 572 | 15 | 6 |
| 305 05 81 573 | 20 | 7,7/8 |

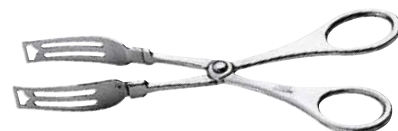

Spatola crepes professionale

Professional crepes server
Spatule à crêpes professionnelle
Pala crepes profesional
Crepesschaufel

| | Cm | In. |
|---------------|------|--------|
| 903 05 91 065 | 29,2 | 11,8/2 |



Coltello torta professionale

Professional cake knife
Couteau à tarte professionnel
Cuchillo tarta profesional
Tortenmesser

| | Cm | In. |
|---------------|------|--------|
| 903 05 91 798 | 29,7 | 11,3/4 |



Coltello torta professionale seghettato

Professional cake knife, serrated-edge
Couteau à tarte professionnel lame dentelée
Cuchillo tarta profesional dentado
Tortenmesser

| | Cm | In. |
|---------------|------|--------|
| 903 05 91 788 | 29,7 | 11,3/4 |



Pala torta professionale

Professional cake server
Pelle à tarte professionnelle
Pala tarta profesional
Tortenschaufel

| | Cm | In. |
|---------------|------|--------|
| 903 05 91 799 | 29,7 | 11,3/4 |



Pala torta seghettata professionale

Professional cake server, serrated-edge
Pelle à tarte professionnelle lame dentelée
Pala tarta profesional dentada
Tortenschaufel

| | Cm | In. |
|---------------|------|--------|
| 903 05 91 786 | 29,7 | 11,3/4 |



Complementi

Pala gratin professionale

Professional gratin server
Pelle à gratin professionnelle
Pala lasaña profesional
Lasagne-Spachtel

| | Cm | In. |
|---------------|------|--------|
| 903 05 91 797 | 26,8 | 10,5/8 |



Pala gratin professionale seghettata

Professional gratin server, serrated-edge
Pelle à gratin professionnelle dentelée
Pala lasaña profesional dentada
Lasagne-Spachtel, gezahnt

| | Cm | In. |
|---------------|------|--------|
| 903 05 91 787 | 26,8 | 10,5/8 |



Cucchiaione riso professionale

Professional rice-serving spoon
Cuillère à servir riz professionnelle
Cucharón servir arroz profesional
Reislöffel

| | Cm | In. |
|---------------|------|-----|
| 903 05 91 795 | 25,6 | 10 |



Pala fritto professionale

Professional frying shovel
Pelle à frire professionnelle
Pala fritos profesional
Schaufel

| | Cm | In. |
|---------------|------|--------|
| 903 05 91 062 | 29,5 | 11,5/8 |



Cucchiaione forato professionale

Professional serving spoon perforated
Cuillère à servir perforé professionnel
Cucharón servir con agujeros profesional
Servierlöffel, gelocht

| | Cm | In. |
|---------------|----|--------|
| 903 05 91 796 | 29 | 11,1/2 |



Cucchiaine ghiaccio professionale

Professional ice-serving spoon
Cuillère à servir glaçons professionnelle
Cucharón servir hielo profesional
Eislöffel

| | Cm | In. |
|---------------|----|--------|
| 903 05 91 063 | 29 | 11,1/2 |



Cucchiaine insalata professionale

Professional salad-serving spoon
Cuillère à salade professionnelle
Cucharón ensalada profesional
Salatlöffel

| | Cm | In. |
|---------------|------|--------|
| 903 05 91 066 | 28,5 | 11,1/4 |



Cucchiaine servire professionale

Professional serving spoon
Cuillère à servir professionnel
Cucharón servir profesional
Servierlöffel

| | Cm | In. |
|---------------|----|--------|
| 903 05 91 793 | 29 | 11,1/2 |



Forchettone servire professionale

Professional serving fork
Fourchette à servir professionnelle
Tenedor servir profesional
Serviergabel

| | Cm | In. |
|---------------|------|--------|
| 903 05 91 794 | 29,4 | 11,5/8 |



Coltellone pane/dolce

Regis bread knife
Gros couteau à pain Regis
Cuchillo pan Regis
Kuchmesser Regis

| | Cm | In. |
|---------------|------|-----|
| 903 05 84 788 | 30,3 | 12 |







Posateria - Cutlery

Finiture Speciali - Special Finishes

Finiture di tendenza e nuances raffinate che suscitano nuove sensazioni, trasmettono stile e personalizzano la mise en place.

Trendy finishes and refined nuances that arouse new sensations, convey style and personalise the mise-en-place.

Finitions de tendance et nuances raffinées qui donnent des sensations nouvelles, en transmettant style et en personnalisant la mise en place des tables.

Acabados de tendencia y tonos refinados que provocan nuevas sensaciones, transmiten estilo y personalizan la mise en place.

Trendige Oberflächen und raffinierte Nuancen, die neue Empfindungen wecken, Stil vermitteln und das Mise en Place personalisieren.

Vintage

L'opacità, i graffi ed i segni volutamente prodotti sulla superficie delle posate con finitura Vintage danno la sensazione di oggetti vissuti ed utilizzati a lungo, di grandi cucine profumate, calde e piene di vapore, di convivialità di altri tempi, di sapori antichi. Evocano immagini di ambienti tradizionali, rustici e senza pretese di modernità.

Opacity, scratches and marks intentionally made on the surface of the cutlery with a Vintage finish give the effect of objects that have been used for a long time, of a large, warm and steamy kitchen filled with aromas, of the friendly gatherings of old good times and ancient flavours. They evoke images of traditional, simple environments with no intention to be modern.

L'opacità, les égratignures et les marques intentionnellement produites sur la surface des couverts à finition Vintage donnent le sentiment d'objets vécus et utilisés depuis longtemps, de grandes cuisines odorantes, chaudes et pleines de vapeur, de convivialité d'autrefois, de saveurs d'antan. Elles évoquent des images de lieux traditionnels, rustiques et sans prétention de modernité.

La opacidad, los rasguños y las marcas producidos deliberadamente en la superficie de los cubiertos con acabado Vintage dan la sensación de objetos vividos y utilizados por largo tiempo, de grandes cocinas perfumadas, cálidas y llenas de vapor, de convivialidad de otros tiempos, de sabores antiguos. Evocando imágenes de ambientes tradicionales, rústicos y sin pretensiones de modernidad.

Der Mattglanz, die "Kratzer" und gezielt in die Oberfläche eingearbeiteten Zeichen der Serie 'Vintage' verleihen diesem Besteck einen besonders raffinierten Look von seit langem benutzten Gegenständen, erinnern an die Atmosphäre großer gemütlicher Wohnküchen von früher, wo es herrlich nach den Gerichten unserer Kindheit duftete. Sie rufen Bilder traditioneller Ambiente wach, ohne dem Anspruch moderner Stilformen nachzugeben.

Polvere di Luna

La finitura Polvere di Luna rende l'aspetto delle posate satinato e delicatamente brillante: una superficie levigata con chiaroscuri. Piacevoli e vellutate al tatto, trasmettono una morbidezza ed un calore inconsueto per oggetti di acciaio. Un rivestimento sobrio ed inusuale per posate contemporanee.

The Polvere di Luna finish makes cutlery surface look satin-like and delicately brilliant: a smooth surface with contrasting shades. Pleasant and velvety to the touch, the cutlery so treated convey a softness and warmth unusual for steel objects. A sober and unusual coating for contemporary cutlery.

La finition Polvere di Luna rend l'aspect des couverts satiné et délicatement brillant : une surface polie avec des clairs-obscur. Agréables et veloutées au toucher, ils transmettent une douceur et une chaleur insolites pour des objets en acier. Un revêtement sobre et inusuel pour des couverts contemporains.

El acabado Polvere di Luna confiere a los cubiertos un aspecto satinado y delicadamente brillante: una superficie pulida con claroscuros. Agradables y aterciopelados al tacto, transmiten una suavidad y una calidez insólitas en objetos de acero. Un revestimiento sobrio e inusual para cubiertos contemporáneos.

Die Oberflächenbearbeitung 'Polvere di Luna' verleiht dem Besteck samtlichen Glanz mit edlen hell-dunkel Schattierungen. Von ausgesprochen gepflegter Haptik, liegt dieses Besteck weich und besonders angenehm in der Hand und strahlt eine für Stahl ungewöhnliche Wärme aus. Ein dezentes und einzigartiges Oberflächenfinish für zeitgenössisches Besteck.

Scotch-Brite

Questo effetto superficiale, tipicamente utilizzato nell'architettura di interni, è caratterizzato dalla presenza di molteplici e lievissime graffiature longitudinali; dona al metallo una sembianza velata e luminosa al tempo stesso, conferendo agli oggetti che riveste un aspetto di brillantezza pacata, di acciaio non lucente. Per utensili che evocano il design di stile nordico.

This superficial effect, typically used in the interior architecture, is characterized by the presence of numerous and very light longitudinal scratches; it adds to the metal a veiled and bright appearance at the same time, bestowing to the objects it covers an aspect of measured brilliance, of non-glowing steel. For tools that evoke northern design.

Cet effet de surface, typiquement utilisé dans l'architecture d'intérieur, se caractérise par la présence de plusieurs et très légères éraflures longitudinales; cela rend le métal d'une apparence voilée et lumineuse en même temps, en donnant aux objets un aspect d'éclat paisible, d'acier pas brillant. Pour outils qui évoquent le design du style nordique.

Este efecto superficial, típicamente utilizado en la arquitectura de interiores, se caracteriza por la presencia de múltiples rasguños longitudinales; proporciona al metal una apariencia velada y luminosa al mismo tiempo, otorgando a los objetos que cubre un aspecto de brillo sosegado, de acero no reluciente. Para utensilios que evocan diseño de estilo nórdico.

Dieser Oberflächeneffekt, der typischerweise in der Innenarchitektur verwendet wird, charakterisiert sich für das Vorhandensein mehrerer und sehr geringer Längskratzer. Es verleiht dem Metall gleichzeitig einen verschleierten und leuchtenden Anschein und verleiht den Objekten, die es abdeckt, einen Aspekt ruhiger Brillanz und nicht glänzenden Stahls. Scotch-brite ist ideal für Werkzeuge, die an das nordische Design erinnern.





Vintage

cod. ...51

Finitura disponibile per tutti i modelli

Finish available for all models

Minimo di ordine 500 pz assortiti

500 assorted pcs minimum order

Minimum commande 500 pcs assortis

Pedido mínimo 500 pzs surtidas

Mindest Bestellung 500 stck gemischt



Polvere di Luna

cod. ...32

Finitura disponibile per tutti i modelli

Finish available for all models

Non disponibile per posate a manico cavo

Not available for hollow-handle cutlery

Minimo di ordine 500 pz assortiti

500 assorted pcs minimum order

Minimum commande 500 pcs assortis

Pedido mínimo 500 pzs surtidas

Mindest Bestellung 500 stck gemischt



Scotch-Brite

cod. ...73

Finitura disponibile per tutti i modelli

Finish available for all models

Non disponibile pr posate in PVD

Not available for PVD cutlery

Minimo di ordine 500 pz assortiti

500 assorted pcs minimum order

Minimum commande 500 pcs assortis

Pedido mínimo 500 pzs surtidas

Mindest Bestellung 500 stck gemischt

The PVD (Physical Vapour Deposition) technique allows to deposit a high-thickness metal film with remarkable characteristics from the decorative and technical point of view. Such process makes the product treated durable in time and gives high surface hardness. The item turns resistant to solvents, acids and to various products used in the kitchen, keeping its chemical/physical characteristics unchanged. It is a thoroughly biocompatible, anallergic treatment and suitable for food contact.

La technique PVD (Physical Vapour Deposition) permet de déposer un film métallique de haute épaisseur avec des caractéristiques surprenantes du point de vue décoratif et technique. Ce processus rend le produit traité durable et confère une dureté superficielle élevée. L'article devient résistant aux solvants, aux acides et aux différents produits employés en cuisine, gardant intactes ses propres caractéristiques chimio/physiques. C'est un traitement absolument biocompatible, anallergique et approprié au contact avec la nourriture.

La técnica PVD (Physical Vapour Deposition) permite depositar una película metálica de alto grosor con características sorprendentes desde el punto de vista decorativo y técnico. Este procedimiento hace que el producto tratado sea duradero en el tiempo y le confiere una elevada dureza superficial. El artículo se torna resistente a los solventes, a los ácidos y a los diversos productos empleados en la cocina, manteniendo intactas sus características químico/físicas. Es un tratamiento absolutamente biocompatible, antialérgico y apto para el contacto con los alimentos.

Die PVD Technik ermöglicht die Beschichtung mit einem dickwandigen Metallfilm von überraschenden dekorativen und technischen Merkmalen. Das Verfahren verleiht dem Produkt längere Lebensdauer und eine ausgeprägte Oberflächenhärte, macht beständig gegen Lösungsmittel, Säuren und verschiedene Haushaltsmittel, wobei die chemischen und physischen Eigenschaften des Produkts selbst intakt bleiben. Die Behandlung ist absolut bioverträglich, allergiefrei und lebensmitteltauglich.

PVD

La tecnica PVD (Physical Vapour Deposition) permette di depositare un film metallico di alto spessore con caratteristiche sorprendenti dal punto di vista decorativo e tecnico. Questo procedimento rende il prodotto trattato durevole nel tempo e conferisce elevata durezza superficiale. L'articolo diventa resistente ai solventi, agli acidi e a vari prodotti usati in cucina, mantenendo intatte le proprie caratteristiche chimico/fisiche. E' un trattamento assolutamente biocompatibile, anallergico ed idoneo al contatto con il cibo.

**Lucido
PVD oro**

*Mirror PVD Gold
cod. ...41*



**Lucido
PVD rame**

*Mirror PVD Copper
cod. ...40*



**Lucido
PVD nero**

*Mirror PVD Black
cod. ...42*



**Lucido
PVD bronzo**

*Mirror PVD Bronze
cod. ...85*





**Polvere di Luna
PVD oro**

Moon dust PVD Gold
cod. ... 35



**Polvere di Luna
PVD rame**

Moon dust PVD Copper
cod. ...53



**Polvere di Luna
PVD nero**

Moon dust PVD Black
cod. ...39



**Polvere di Luna
PVD bronzo**

Moon dust PVD Bronze
cod. ...83





Vintage PVD oro

Vintage PVD Gold
cod. ...57



Vintage PVD rame

Vintage PVD Copper
cod. ...56



Vintage PVD nero

Vintage PVD Black
cod. ...75



Vintage PVD bronzo

Vintage PVD Bronze
cod. ...84









Vasellame - Hollowware

Finiture speciali - Special Finishes

The range of special finishes can be applied to hollowware products as well, creating contemporary taste combinations. Matching finishes and colours you can customise your style, enhancing it with new looks and unusual effects.

La gamme de finitions spéciales peut être appliquée aux accessoires aussi, en créant combinaisons du goût contemporain. En assortant finitions et couleurs il est possible de personnaliser son propre style, en l'enrichissant par présentations nouvelles et effets inhabituels.

La gama de acabados especiales se puede aplicar en productos de vajilla también, creando mezclas de gusto contemporáneo. Combinando acabados y colores es posible personalizar su estilo, enriqueciéndolo con nuevas presentaciones y efectos insólitos.

Die Serie von Spezialoberflächen kann auch auf Geschirrprodukte angewendet werden. Auf diese Weise man kann Kombinationen mit einem zeitgemäßen Geschmack erschaffen. Durch die Kombination von Oberflächen und Farben können Sie Ihren eigenen Stil anpassen und ihn mit neuer Kleidung und ungewöhnlichen Effekten bereichern.

Vasellame - Hollowwere

Finiture speciali - Special Finishes

La gamma di finiture speciali può essere applicata anche ai prodotti di vasellame, creando combinazioni dal gusto contemporaneo. Abbinando finiture e colori è possibile personalizzare il proprio stile, arricchendolo con vesti nuove ed effetti inconsueti.



**Lucido
PVD oro**

Mirror PVD Gold
cod. ...41

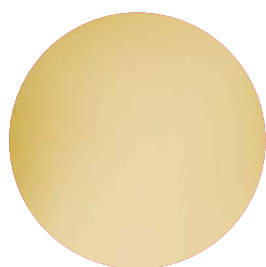

**Lucido
PVD rame**

Mirror PVD Copper
cod. ...40



**Lucido
PVD nero**

Mirror PVD Black
cod. ...42





**Polvere di Luna
PVD oro**

Moon dust PVD Gold
cod. ... 35



**Polvere di Luna
PVD rame**

Moon dust PVD Copper
cod. ...53



**Polvere di Luna
PVD nero**

Moon dust PVD Black
cod. ...39

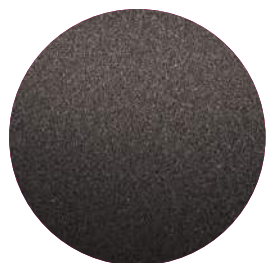



Vintage PVD oro

Vintage PVD Gold
cod. ...57

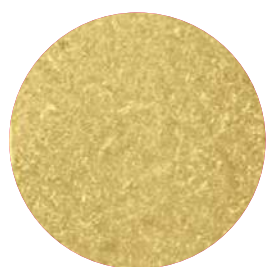

Vintage PVD rame

Vintage PVD Copper
cod. ...56

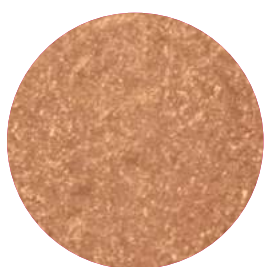

Vintage PVD nero

Vintage PVD Black
cod. ...58











A photograph of a dining table set with clear glassware and silverware. The table has a dark wood-grain finish. In the center, a clear glass tumbler sits on a square glass coaster. To its left, a silver fork and knife are laid out on a dark rectangular napkin. Another similar set is visible in the foreground, and a third is partially visible in the background. The lighting is soft, highlighting the textures of the glass and wood. The text "Mix&Match" is overlaid in white, bold font in the middle-right area of the image.

Mix&Match



Poggiaposate Piatto





Cutlery stand, flat
Porte-couverts plat
Posa cubiertos plano
Besteckhalter flach

| | | cm | in | colore/color |
|---|---------------|----------|---------------|--------------|
|  | 305 04 81 722 | 25 x 8,5 | 9,7/8 x 3,3/8 | noce/walnut |
|  | 305 04 81 723 | 25 x 8,5 | 9,7/8 x 3,3/8 | wengè/wenge |
|  | 305 04 81 724 | 25 x 8,5 | 9,7/8 x 3,3/8 | grigio/grey |
|  | 305 04 81 725 | 25 x 8,5 | 9,7/8 x 3,3/8 | nero/black |



Poggiaposate Onda





Cutlery stand, wave
Porte-couverts onde
Posa cubiertos onda
Besteckhalter wellig

| | | cm | in | colore/color |
|---|---------------|----------|---------------|--------------|
|  | 305 04 81 718 | 25 x 8,5 | 9,7/8 x 3,3/8 | noce/walnut |
|  | 305 04 81 719 | 25 x 8,5 | 9,7/8 x 3,3/8 | wengè/wenge |
|  | 305 04 81 720 | 25 x 8,5 | 9,7/8 x 3,3/8 | grigio/grey |
|  | 305 04 81 721 | 25 x 8,5 | 9,7/8 x 3,3/8 | nero/black |



Poggiaposate Curvo

Cutlery stand, curved
Porte-couverts courbé
Posa cubiertos onda
Besteckhalter gebogen



| | | cm | in | colore/color |
|---|---------------|----------|----------------|--------------|
|  | 305 04 81 726 | 26 x 8,5 | 10,1/4 x 3,3/8 | noce/walnut |
|  | 305 04 81 727 | 26 x 8,5 | 10,1/4 x 3,3/8 | wengè/wenge |
|  | 305 04 81 728 | 26 x 8,5 | 10,1/4 x 3,3/8 | grigio/grey |
|  | 305 04 81 729 | 26 x 8,5 | 10,1/4 x 3,3/8 | nero/black |





Poggiaposate double face



Cutlery stand double-sided
Porte-couverts double-face
Posa cubiertos reversible
Besteckhalter, beidseitig

| | | cm | in | colore/color |
|---|---------------|----------------|---------------|--------------------------------|
|  | 305 04 81 716 | 25 x 8,5 x 2,5 | 9,7/8 x 3,3/8 | wengè + noce wenge + walnut |
|  | 305 04 81 717 | 250 x 85 x 2,5 | 9,7/8 x 3,3/8 | nero + grigio black + grey |



Tovaglietta double face

Placemat double-sided
Posa cubiertos reversible
Mantel individual reversible
Tischset, beidseitig

| | | cm | in | colore/color |
|---|---------------|---------|-----------------|--------------------------------|
|  | 305 04 27 505 | 45 x 30 | 17,3/4 x 11,3/4 | wengè + noce wenge + walnut |
|  | 305 04 27 506 | 45 x 30 | 17,3/4 x 11,3/4 | nero + grigio black + grey |



FINITURE DISPONIBILI AVAILABLE FINISHES

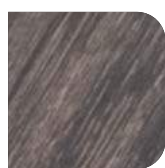

Wengé
Wenge

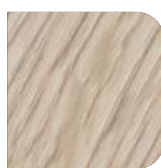

Noce
Walnut



Nero
Black





Grigio
Grey



Sottobicchiere double face in HPL

Glasscoaster double-sided
Dessous de verre reversible
Posavasos reversible
Glassuntersetzer beidseitig

| | | cm | in | colore/color |
|---|---------------|-----------|---------------|-----------------------------|
|  | 305 04 21 539 | 8,5 x 8,5 | 3,3/8 x 3,3/8 | wengè + noce/wenge + walnut |
|  | 305 04 21 540 | 8,5 x 8,5 | 3,3/8 x 3,3/8 | nero + grigio /black + grey |



Sottobicchiere in acciaio double face lucido/satinato

Double sided mirror/mat glass coaster
Dessous de verre Acier Inox double-face poli/brossé
Posavasos reversible Acero Inox pulido/satinado
Glassuntersetzer; beidseitig, Edelstahl, glänzend-matt

| | cm | in |
|---------------|-----------|---------------|
| 305 05 21 538 | 8,5 x 8,5 | 3,3/8 x 3,3/8 |



Sottobicchiere tondo in acciaio double face lucido/satinato

Double sided mirror/mat glass coaster, round,
Dessous de verre rond Acier Inox double-face poli/brossé
Posavasos redondo reversible Acero Inox pulido/satinado
Glassuntersetzer rund; beidseitig, Edelstahl, glänzend-matt

| | ø cm | ø in |
|---------------|------|-------|
| 305 05 21 541 | 9 | 3,1/2 |





Poggiaposate curvo in acciaio

Cutlery stand curved St.Steel
Porte-couverts courbé en Acier Inox
Posa cubiertos curvado en Acero Inox
Besteckhalter gebogen, Edehstahl

| | cm | in |
|---------------|-----------|---------------|
| 305 05 81 732 | 8,5 x 8,5 | 3,3/8 x 3,3/8 |



Poggiaposate piatto in acciaio

Cutlery stand flat St.Steel
Porte-couverts plat en Acier Inox
Posa cubiertos plano en Acero Inox
Besteckhalter flach, Edehstahl

| | cm | in |
|---------------|-----------|---------------|
| 305 05 81 733 | 8,5 x 8,5 | 3,3/8 x 3,3/8 |



Poggiaposate Branch

Branch cutlery stand
Porte-couverts Branch en Acier Inox
Posa cubiertos Branch en Acero Inox
Besteckhalter Branch, Edelstahl

| | cm | in |
|---------------|---------|---------------|
| 118 05 00 081 | 7,5 x 3 | 2,8/9 x 1,1/5 |



Poggiaposate tondo

Cutlery stand round St.Steel
Porte-couverts rond en Acier Inox
Posa cubiertos redondo en Acero Inox
Besteckhalter rund, Edehstahl

| | cm | in |
|---------------|-------|---------|
| 305 05 81 713 | ø 8,5 | ø 3,3/8 |



Poggiabastoncini Ergo

Ergo cutlery stand St.Steel
Porte-baguettes Ergo en Acier Inox
Posa palillos Ergo en Acero Inox
Esstübchenhalter Ergo, Edelstahl

| | cm | in |
|---------------|-----|-------|
| 903 05 84 662 | 5,6 | 2,1/8 |





Legatovagliolo Spirale

Napkin ring, spiral , St. Steel
Rond de serviettes spirale Acier Inox
Servilletero individual espiral Acero Inox
Serviettenring Spirale, Edelstahl

| | cm | in |
|---------------|-------|---------------|
| 305 05 81 730 | 7 x 5 | 2,3/4 x 1,8/9 |



Legatovagliolo Ovale

Napkin ring, oval St. Steel
Rond de serviettes oval Acier Inox
Servilletero individual oval Acero Inox
Serviettenring Spirale, Edelstahl

| | cm | in |
|---------------|-------|---------------|
| 305 05 81 731 | 6 x 3 | 2,3/8 x 1,1/5 |



Legatovagliolo Tondo

Napkin ring, round St. Steel
Rond de serviettes rond Acier Inox
Servilletero individual redondo Acero Inox
Serviettenring rund, Edelstahl

| | cm | in |
|---------------|-----|---------|
| V01 05 81 001 | ø 4 | ø 1,2/3 |



Legatovagliolo / poggiabastoncini Bamboo

Napkin ring / cutlery stand Bamboo St. Steel
Rond de serviettes/porte-baguettes Bamboo Acier Inox
Servilletero/posa palillos individual Bamboo Acero Inox
Serviettenring Bamboo, Edelstahl

| | cm | in |
|---------------|-------|---------------|
| V01 05 81 005 | 6 x 4 | 2,3/8 x 1,2/3 |







Essenza

Acciaio - 18/10 St. Steel

Supporto secchio Essenza

Champagne bucket stand
 Support pour seau à champagne
 Soporte para champañera
 Ständer für Champagnerkühler Essenza,

| | H. Cm | In |
|---------------|-------|--------|
| 335 05 20 683 | 82 | 32,1/4 |



Secchio champagne Essenza

Champagne bucket Essenza
 Seau à champagnet Essenza
 Champañera Essenza
 Champagnerkühler Essenza

| | Ø Cm | H. Cm | Ø In. | H. In |
|---------------|------|-------|-------|-------|
| 335 05 20 688 | 20.5 | 8,1/8 | 20 | 7,7/8 |



Secchio champagne Essenza con pomoli

Champagne bucket with knobs Essenza
 Seau à champagnet avec poignées Essenza
 Champañera con pomos Essenza
 Champagnerkühler mit Knöpfen Essenza

| | Ø Cm | H. Cm | Ø In. | H. In |
|---------------|------|-------|-------|-------|
| 335 05 20 689 | 20.5 | 20 | 8,1/8 | 7,7/8 |



Alzata pasticceria Essenza

Petit four stand Essenza
Plat à petits fours sur pied Essenza
Soporte para pasteles Essenza
Petit Four Essenza

| | Ø Cm | H. Cm | Ø In | H. In |
|---------------|------|-------|-------|-------|
| 335 05 42 679 | 12,5 | 13 | 4,7/8 | 5,1/8 |
| 335 05 42 680 | 16,5 | 13 | 6,1/2 | 5,1/8 |
| 335 05 42 681 | 22 | 13 | 8,5/8 | 5,1/8 |



Alzata pasticceria Essenza doppia

Petit four stand Essenza 2-tier
Plat à petits fours sur pied 2 Essenza étages
Soporte para pasteles Essenza 2 pisos
Petit Four Essenza St. 2-fach

| | Ø Cm | H. Cm | Ø In | H. In |
|---------------|-----------|-------|---------------|-------|
| 335 05 42 682 | 12,5/16,5 | 17 | 4,7/8 - 6,1/2 | 6,3/4 |
| 335 05 42 683 | 16,5/22 | 17 | 6,1/2 - 8,5/8 | 6,3/4 |



Alzata pasticceria Essenza tripla

Petit four stand Essenza 3-tier
Plat à petits fours sur pied 3 Essenza étages
Soporte para pasteles Essenza 3 pisos
Petit Four Essenza St. 3-fach

| | Ø Cm | H. Cm | Ø In | H. In |
|---------------|--------------|-------|-------------------|--------|
| 335 05 42 684 | 12,5/16,5/22 | 30 | 4,7/8-6,1/2-8,5/8 | 11,3/4 |



Essenza

Alzata frutta/crostacei tonda Essenza

Fruit/seafood stand Essenza, round

Plat à fruit/crustacés rond Essenza

Soporte fruta/mariscos redondo Essenza

Meeresfrüchtestander Essenza

| | Ø Cm | H. Cm | Ø In | H. In |
|---------------|------|-------|--------|-------|
| 335 05 42 686 | 27 | 15 | 10,5/8 | 5,7/8 |
| 335 05 42 687 | 32 | 15 | 12,5/8 | 5,7/8 |



Alzata frutta/crostacei 2 piani tonda Essenza

Fruit/seafood stand Essenza, 2-tier, round

Plat à fruit/crustacés 2 étages rond Essenza

Soporte fruta/mariscos 2 pisos redondo Essenza

Meeresfrüchtestander Essenza 2-fach.

| | Ø Cm | H. Cm | Ø In | H. In |
|---------------|-------|-------|---------------|--------|
| 335 05 42 688 | 27-32 | 30 | 10,5/8-12,5/8 | 11,3/4 |



Centrotavola tondo Essenza

Centrepiece Essenza, round

Centre de table rond Essenza

Centro de mesa redondo Essenza

Tischdeko Essenza

| | Ø Cm | H. Cm | Ø In | H. In |
|---------------|------|-------|--------|-------|
| 335 05 24 609 | 27 | 5 | 10,5/8 | 2 |
| 335 05 24 610 | 32 | 5 | 12,5/8 | 2 |



Alzata frutta/crostacei ovale Essenza

Seafood stand Essenza, oval
Plat à crustacés oval Essenza
Soporte mariscos oval Essenza
Meeresfrüchtestander oval Essenza

| | Cm | H. Cm | In | H. In |
|---------------|-------|-------|--------------|-------|
| 335 05 42 689 | 19x33 | 15 | 7,1/2x13 | 5,7/8 |
| 335 05 42 690 | 24x42 | 15 | 9,1/2x16,1/2 | 5,7/8 |



Alzata frutta/crostacei 2 piani ovale Essenza

Fruit/seafood stand Essenza, 2-tier, oval
Plat à fruit/crustacés 2 étages ovale Essenza
Soporte fruta/mariscos 2 pisos oval Essenza
Meeresfrüchtestander Essenza 2-fach.

| | Cm | H. Cm | In | H. In |
|---------------|---------------|-------|-----------------------|--------|
| 335 05 42 691 | 19x33 - 24x42 | 30 | 7,1/2x13-9,1/2x16,1/2 | 11,3/4 |



Centrotavola ovale Essenza

Centrepiece Essenza, oval
Centre de table oval Essenza
Centro de mesa oval Essenza
Tischdeko oval Essenza

| | Cm | H. Cm | In | H. In |
|---------------|-------|-------|--------------|-------|
| 335 05 24 611 | 19x33 | 5 | 7,1/2x13 | 5,7/8 |
| 335 05 24 612 | 24x42 | 5 | 9,1/2x16,1/2 | 5,7/8 |



Essenza

Cestino pane e frutta tondo con manico in pelle

Round bread basket leather handle
Corbeille à pain rond avec manche en cuir
Cesta pan redonda con asas de piel
Brotkorb rund mit Lederriemen

| | Cm ø | In ø |
|---------------|------|-------|
| 305 05 24 596 | 20 | 7,7/8 |



Cestino pane e frutta tondo

Round bread and fruit basket
Corbeille à pain rond
Cesta pan redonda
Brotkorb rund

| | Cm ø | In ø |
|---------------|------|-------|
| 305 05 24 599 | 20 | 7,7/8 |



Cestino pane/frutta ovale con manico in pelle

Oval bread basket leather handle
Corbeille à pain oval manche en cuir
Cesta pan oval asas de piel
Brotkorb oval mit Lederriemen

| | Cm ø | In ø |
|---------------|---------|-------------|
| 305 05 24 597 | 22,5x13 | 8,7/8x5,1/8 |



Cestino pane/frutta ovale

Oval bread basket
Corbeille à pain oval
Cesta pan oval
Brotkorb oval

| | Cm ø | In ø |
|---------------|---------|-------------|
| 305 05 24 600 | 22,5x13 | 8,7/8x5,1/8 |



Portapane Carasau Acciao Inox

Bread basket Essenza St. Steel
 Corbeille à pain en Acier Inox
 Cesta para pan en Acero Inox
 Brotkorb, Edelstahl

| | Cm | In. | H. Cm | H. In |
|---------------|-------|-------------|-------|-------|
| 305 05 24 606 | 13x11 | 5,1/8x4,3/8 | 9 | 3,1/2 |

Portapane - Noce

Bread basket, walnut
 Corbeille à pain noix
 Cesta para pan nogal
 Brotkorb, Wallnuss

| | Cm | In. | H. Cm | H. In |
|---------------|-------|-------------|-------|-------|
| 305 54 24 604 | 15x15 | 5,7/8x5,7/8 | 3 | 1x1/8 |



Portagrissini - Noce

Breadsticks basket, walnut
 Corbeille à gressins noix
 Cesta para pan nogal
 Grissini-Korb, Walnuss

| | Cm | In. | H. Cm | H. In |
|---------------|-------|--------------|-------|-------|
| 305 54 24 605 | 10x32 | 3,7/8x12,5/8 | 3 | 1x1/8 |

Alzata pasticceria 2 piani

Petit fours stand
 Plat à petits fours sur pied
 Petit Four Stand
 Soporte pasteles

Noce - Walnut

| | H. Cm | H. In |
|---------------|-----------|-------|
| 305 54 42 671 | 23,5x24,4 | 12 |



Alzata pasticceria Noce

Cake stand, walnut
 Présentoir à gâteaux en bois de noyer
 Presentación tarta en madera de nogal
 Tortenplatte Walnussholz

Noce - Walnut

| | ø Cm | H. Cm | ø In | H. In |
|---------------|------|-------|-------|-------|
| 305 54 42 692 | 16 | 9 cm | 6,1/4 | 3,1/2 |



Espositore piccola pasticceria

Petits fours display
 Présentoir à petits fours
 Soporte para pasteles
 Ständer für kleine Gebäcke

| | ø mm | H. mm | ø In | H. In | Fori/holes |
|---------------|------|-------|-------|-------|------------|
| 607 P0 68 117 | 165 | 145 | 6,1/2 | 6,1/2 | 9 |



Cestini pane



Cestino pane cotone écru

Bread basket, cotton, écru
 Corbeille à pain coton écru
 Cesta pan algodón color crudo
 Brotkorb Rohbaumwolle

| | Cm | H. Cm | In. | H. In |
|---------------|---------|-------|---------------|-------|
| 325 01 24 576 | 14 x 14 | 8 | 5,1/2 x 5,1/2 | 3,1/8 |
| 325 01 24 577 | 20 x 20 | 10 | 7,7/8 x 7,7/8 | 4 |



Cestino pane misto lino, beige

Bread basket, linen blend, beige grain
 Corbeille à pain médis, gros grain beige
 Cesta pan lino mezclado con algodón, grano beis
 Brotkorb Mischleinen Beige-Korn

| | Cm | H. Cm | In. | H. In |
|---------------|---------|-------|---------------|-------|
| 325 02 24 576 | 14 x 14 | 8 | 5,1/2 x 5,1/2 | 3,1/8 |
| 325 02 24 577 | 20 x 20 | 10 | 7,7/8 x 7,7/8 | 4 |



Cestino pane cotone, grana nera

Bread basket, cotton, black grain
 Corbeille à pain coton, gros grain noir
 Cesta pan algodón, grano negro
 Brotkorb Baumwolle Schwarz Korn

| | Cm | H. Cm | In. | H. In |
|---------------|---------|-------|---------------|-------|
| 325 03 24 576 | 14 x 14 | 8 | 5,1/2 x 5,1/2 | 3,1/8 |
| 325 03 24 577 | 20 x 20 | 10 | 7,7/8 x 7,7/8 | 4 |



Cestini pane



Cuscino termico

Thermal cushion
 Coussin chauffant
 Cojín térmico
 Wärme Kisse

| | Cm | In. |
|-----------------|-------------|-------|
| Piccolo - Small | | |
| 325 05 24 579 | 12,5 x 12,5 | 5 x 5 |
| Grande - Large | | |
| 325 05 24 580 | 18 x 18 | 7 x 7 |



Cestino pane tessuto

Bread basket
 Corbeille à pain
 Cesta pan
 Stoff Brotkorb

| | Cm | In. |
|-----------------|-------------|-------|
| Marrone - Brown | | |
| 305 29 24 581 | 12,5 x 12,5 | 5 x 5 |
| 305 29 24 582 | 18 x 18 | 7 x 7 |
| Beige - Beige | | |
| 305 29 24 583 | 12,5 x 12,5 | 5 x 5 |
| 305 29 24 584 | 18 x 18 | 7 x 7 |

Carbon fibre tray Broggi. Always at the forefront in the use of innovative materials, present a new tray with a modern and attractive design, made of carbon fibre - a very resistant yet lightweight material - suitable for food use. The lightest tray ever - just 1010 g. - for a professional service done effortlessly. The product is stackable, with a special BLACK PVD handle designed to reduce overall dimensions during storage. Suitable for table service and room service; it can carry up to four 33-cm plates. Technology, lightness, practicality, modernity. All these factors turn a carbon tray into an indispensable tool in the most prestigious places.

Plateau en fibre de carbone. Broggi, comme toujours à l'avant-garde dans l'utilisation de matériaux innovants, présente un nouveau plateau au design moderne et attrayant en fibre de carbone, un matériau très résistant et en même temps léger, approprié à l'usage alimentaire. Le plateau plus léger que jamais - seulement 1010 gr. - permet d'effectuer un service professionnel plus facilement. Le produit est empilable sur lui-même avec une poignée spéciale en PVD BLACK, conçue pour économiser de l'espace lors du stockage. Approprié tant pour le service à table que pour le service en chambre, il peut transporter jusqu'à 4 plats de 33 Cm Technologie, légèreté, fonctionnalité, modernité, font du plateau au carbone un instrument indispensable pour les établissements les plus prestigieux.

Bandeja de fibra de carbono. Broggi, siempre a la vanguardia en el empleo de materiales innovadores, presenta una nueva bandeja de diseño moderno y atractivo realizado con fibra de carbono, material muy resistente y al mismo tiempo liviano, adecuado para el uso alimentario. La bandeja más liviana que nunca - sólo 1010 gr. - permite llevar a cabo un servicio profesional de modo más confortable. El producto puede ser apilado sobre si mismo con una manija especial de PVD BLACK, estudiada para reducir el estorbo durante el almacenamiento. Adecuada tanto para el servicio a la mesa como para el room service, puede llevar hasta 4 platos de 33 Cm Tecnología, ligereza, funcionalidad, modernidad, hacen de la bandeja de fibra de carbono un instrumento indispensable en los locales más prestigiosos.

Tablett aus carbonfaser. Broggi, immer ganz vorn beim Einsatz innovativer Werkstoffe, stellt ein neues Tablett aus Carbonfaser von modernem und ansprechendem Design vor. Das Material, Kohlenstoff-Faser, ist leicht, gleichzeitig extrem beständig und eignet sich vorzüglich für den Umgang mit Lebensmitteln. Das leichteste Tablett aller Zeiten - gerade mal 1010 g. - macht den gewerblichen Einsatz noch handlicher. Es ist stapelbar, mit einem besonders praktischen PVD Black Griff in bedienerfreundlicher Ausführung. Mit großzügiger Aufnahmefläche - hier finden 4 Teller von 33 Cm Durchmesser Platz - eignet es sich zur Bedienung am Tisch ebenso wie für den Room service. Technologie, Leichtigkeit, Funktionalität, Fortschritt, vier "Merkmale", die dieses Kohlenstoff-Faser Tablett zu einem praktischen Helfer auch im feinsten Lokal machen.

Vassoio in fibra di **Carbonio**

Broggi, sempre all'avanguardia nell'utilizzo di materiali innovativi, presenta un nuovo vassoio dal design moderno e accattivante in fibra di carbonio, materiale molto resistente e al tempo stesso leggero, adatto all'uso alimentare. Il vassoio più leggero di sempre - solo 1010 gr. - permette di svolgere un servizio professionale in modo più agevole. Il prodotto è impilabile su se stesso con una maniglia speciale in PVD BLACK, studiata per ridurre gli ingombri durante lo stoccaggio. Adatto sia per il servizio al tavolo sia per il room service, può portare fino a 4 piatti da 33 Cm Tecnologia, leggerezza, funzionalità, modernità, rendono il vassoio al carbonio uno strumento indispensabile nei locali più prestigiosi.

Vassoio carbonio



Vassoio in fibra di
Carbonio

Carbon fibre tray
Plateau en fibre de carbone
Bandeja de fibra de carbono
Tablett aus Holzfaserplatte



Vassoio in fibra di carbonio

Carbon fibre tray
 Plateau en fibre de carbone
 Bandeja de fibra de carbono
 Tablett aus Holzfaserplatte

Con maniglie acciaio - with St. Steel handles

| | Cm | In | g | lb |
|---------------|-------------------|-----------------|------|-------|
| 305 05 23 851 | est./out. 67 x 52 | 26,3/8 x 20,1/2 | 1010 | 2,227 |
| | int./ins. 62 x 48 | 24,3/8 x 19 | | |

Con maniglie acciaio argentato - with EPSS handles

305 07 23 851

Con maniglie PVD black - with black PVD handles

305 42 23 851

Vassoio rett. carbonio c/man. incassate

| | Cm | In | g | lb |
|---------------|-------------------|-----------------|-----|------|
| 305 05 23 879 | est./out. 48 x 36 | 18,7/8 x 14,1/8 | 390 | 0,85 |
| | int./ins. 43 x 32 | 16,7/8 x 12,5/8 | | |

Tappetino antiscivolo

Non-slip mat
 Tapis antidérapant
 Rutschfeste Matte
 Alfombrilla antideslizante

| | Cm | In. |
|---------------|---------|-----------------|
| 305 12 27 503 | 62 x 48 | 24,3/8 x 19 |
| 305 12 27 512 | 43 x 32 | 16,7/8 x 12,5/8 |





Legno massello nero opaco con maniglie in acciaio Inox 18/10

Mat black solid wood with 18/10 st. steel handles

Vassoio Pigreco quadrato in legno

Pigreco Square Tray

Plateau carré Pigreco

Bandeja cuadrada Pigreco

Tablett, quadratisch, Pigreco



| | cm | in |
|---------------|-------------------|-----------------------|
| 319 04 23 875 | 39,5 x 39,5 x h.5 | 15,1/2 x 15,1/2 x h.2 |

Vassoio Pigreco Room Service

Pigreco Room Service Tray

Plateau room-service Pigreco

Bandeja room-service Pigreco

Room-Service Tablett, Pigreco



| | cm | in |
|---------------|-------------------|-----------------------|
| 319 04 23 874 | 60 x 39,5 x h.5 | 23,5/8 x 15,1/2 x h.2 |
| 319 04 23 878 | 64,5 x 50,5 x h.5 | 25,3/8 x 19,7/8 x h.2 |

Pliant pieghevole in legno

Folding support for trays, wood

Support pliant en bois pour plateaux

Soporte plegable de madera para bandejas

Faltbarer Tablettständer, Holz



| | H. Cm | H. In |
|---------------|-------------------|----------------------|
| 319 04 23 882 | 30,5 x 17,5 x h.4 | 12 x 6,7/8 x h.1,1/2 |



Legno massello nero opaco con maniglie in acciaio Inox 18/10

Mat black solid wood with 18/10 st. steel handles

Vassoio rett. Pigreco Tea Time

Pigreco Rectangular Tea Time Tray

Plateau rectangulaire Tea Time Pigreco

Bandeja rectangular Tea Time Pigreco

Time Tablett, rechteckig, Pigreco



| | cm | in |
|---------------|-----------------|-----------------------|
| 319 04 23 872 | 80 x 49,5 x h.5 | 31,1/2 x 19,1/2 x h.2 |
| 319 04 23 873 | 80 x 49,5 x h.5 | 31,1/2 x 19,1/2 x h.2 |

PER CARRELLO / FOR TRAY

Portaposate Pigreco

Pigreco Cutlery Stand

Porte-couverts Pigreco

Posa cubiertos Pigreco

Besteckhalter PiGreco



| | cm | in |
|---------------|-------------------|----------------------|
| 319 04 24 598 | 30,5 x 17,5 x h.4 | 12 x 6,7/8 x h.1,1/2 |

Tovaglietta antiscivolo in ecopelle per vassoio

Artificial leather placemat for tray

Set de table peau artificielle pour plateau

Mantel individual piel sintética para bandeja

Kunstlerset für Tablett

| | cm | in |
|---------------|-------------|-----------------|
| 319 12 27 507 | 30,5 x 17,5 | 12 x 6,7/8 |
| 319 12 27 508 | 39,5 x 39,5 | 15,1/2 x 15,1/2 |
| 319 12 27 509 | 60 x 39,5 | 23,5/8 x 15,1/2 |
| 319 12 27 510 | 64,5 x 50,5 | 25,3/8 x 19,7/8 |
| 319 12 27 511 | 80 x 49,5 | 31,1/2 x 19,1/2 |





Podium is a complete tray collection for all occasions,

from cocktails to desserts, from hotels and restaurants to banqueting, for all possible combinations and versions. The edge has a "rise and fall" movement: it goes up when the tray is carried, preventing the spilling of the content, and lowers itself when it is placed on a flat surface, turning the tray into a raised show plate. The range of materials and finishes presented reflects the current trends and blends together with completely different mises en places. The steel bases are solid and very simple to break up for easy and perfect cleaning. The materials of the tops are certified for food contact, for resistance to abrasion and resistance to chemical agents.

Une collection complète de plateaux pour toutes

les occasions, de l'apéro au dessert, de la restauration privée au banqueting dans toutes les formules différentes et déclinaisons. Le bord a un mouvement "montée-descente": il monte quand le plateau est porté, en empêchant la déperdition du contenu, et il descend quand il est posé sur un plan, en transformant le plateau dans un plat de présentation relevé. La gamme des matériaux et finitions proposée reflète les tendances actuelles et s'harmonise facilement avec mises en place très différentes au point de vue esthétique. Les bases en acier sont robustes et très simples à décomposer pour un nettoyage facile et parfait. Les matériaux des plateaux sont certifiés pour le contact direct avec les aliments, pour la résistance à l'abrasion et aux agents chimiques.

Una colección completa de bandejas para todas

las ocasiones, desde el aperitivo hasta el postre, de la restauración privada al banqueting en todas las diferentes fórmulas y declinaciones. El borde tiene un movimiento "subeybaja": sube cuando la bandeja es llevada, impidiendo la salida del contenido, y baja cuando se apoya sobre una superficie llana, transformando la bandeja en un plato de presentación elevado. La gama de materiales y acabados propuesta refleja las tendencias actuales y se armoniza fácilmente con mises en place estéticamente muy diferentes. Las bases de acero son robustas y muy sencillas de descomponer para una limpieza fácil y perfecta. Los materiales de las bandejas están certificados para el contacto con los alimentos, para la resistencia a la abrasión y a los agentes químicos.

Ist eine komplette Sammlung von Tabletten für

alle Gelegenheiten, vom Aperitifs bis zu Desserts, von Hotels und Restaurants bis zu Banketten für alle möglichen Zusammenstellungen und Varianten. Die Kante hat eine „Aufstiegs- und Fallbewegung“: sie geht nach oben, wenn das Tablett getragen wird, verhindernd das Verschütten des Inhalts und senkt sich ab, wenn es auf einer Arbeitsplatte gestellt wird, und verwandelt das Tablett in einer erhöhten Vorlageteller. Das Materialiensortiment und die vorgeschlagenen Feinbearbeitungen spiegelt die aktuellen Trends und Sich harmonisieren leicht mit verschiedenen Einrichtungen (mise en place), die auch ästhetisch viel anders sein können Die Edelstahlfüße sind solide und sehr einfach auszubauen, um eine einfache und perfekte Reinigung. Die Materialien des Brettes sind für den Kontakt mit Lebensmitteln, für Abkratzenfestigkeit und Beständigkeit gegen chemische Mittel zertifiziert.



Design: Massimo Mussapi

Una collezione completa di vassoi per tutte le occasioni, dall'aperitivo al dolce, dalla ristorazione privata al banqueting in tutte le diverse formule e declinazioni. Il bordo ha un movimento "saliscendi": si alza quando il vassoio viene trasportato, impedendo la fuoriuscita del contenuto, e si abbassa quando è appoggiato su piano, trasformando il vassoio in un piatto da presentazione rialzato. La gamma di materiali e finiture proposta rispecchia le tendenze attuali e si armonizza facilmente con mises en place esteticamente molto diverse. Le basi in acciaio sono robuste e semplicissime da scomporre per una facile e perfetta pulizia. I materiali dei piani sono certificati per il contatto diretto con alimenti, per la resistenza all'abrasione e agli agenti chimici.

Podium



Ardesia
Slate



Porcellana
Porcelain



Laminato Stone
Stone Laminat



Laminato Nature
Nature Laminat

Podium



La collezione comprende anche un **supporto mobile** per posizionare il vassoio **tondo girevole** a sbalzo rispetto al tavolo e guadagnare spazio.

The collection includes a **cantilever mobile** stand for the **rotating round tray**, so that it can be placed onto the table and save space.

La collection comprend aussi un **support mobile** pour placer le **tableau rond tournant** en porte-à-faux par rapport à la table et gagner de l'espace.

La colección comprende también un **soporte móvil** para colocar la bandeja **redonda giratoria** en voladizo con respecto a la mesa y ganar espacio.

Die Kollektion umfasst auch einen **beweglichen Gestell** für **das runde und drehbare** Tablett, das auf der Seite des Tisches gestellt werden kann, um auf den Tisch Platz zu sparen.

Supporto da tavolo per vassoio tondo Gueridon

Table stand for round tray Gueridon

Support de table pour tableau rond Gueridon

Soporte de mesa para bandeja redonda Gueridon

Tischständer für rundes Tablett Gueridon

| | Cm | H cm | In | H in |
|---------------|----|------|--------|-------|
| 385 05 24 594 | 32 | 16 | 12,5/8 | 6,1/4 |

Acciaio inox - Stainless steel



Podium tondo rotante

Podium rotating round

Podium rond tournant

Podium redondo giratorio

Rund Podium drehbar

| | | ø Cm | ø In. |
|---------------|--------------------------------------|------|--------|
| 385 05 04 639 | ■ Laminato Nature - Laminated Nature | 34 | 13,1/8 |
| 385 05 04 640 | ■ Laminato Stone - Laminated Stone | 34 | 13,1/8 |
| 385 05 09 642 | ■ Ardesia Slate | 34 | 13,1/8 |



Podium rettangolare

Podium rectangular
 Podium rectangulaire
 Podium rectangular
 Rechteckiges Podium

Cm In.
 28 x 9 11 x 3,1/2

- 385 05 04 652 Laminato Nature - Laminated Nature
- 385 05 04 653 Laminato Stone - Laminated Stone
- 385 05 09 655 Ardesia - Slate
- 385 05 21 656 Porcellana - Porcelain

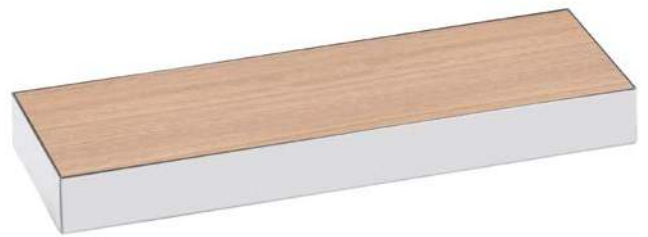

Podium quadrato

Podium square
 Podium carré
 Podium cuadrado
 Viereckiges Podium

Cm In.
 22 x 22 8,5/8 x 8,5/8

- 385 05 04 645 Laminato Nature - Laminated Nature
- 385 05 04 646 Laminato Stone - Laminated Stone
- 385 05 09 648 Ardesia - Slate
- 385 05 21 649 Porcellana - Porcelain



Podium room service

Podium rectangular
 Podium rectangulaire
 Podium rectangular
 Rechteckiges Podium

Cm In.
 60 x 45 23,5/8 x 17,3/4

- 385 05 04 636 Laminato Nature - Laminated Nature
- 385 05 04 637 Laminato Stone - Laminated Stone

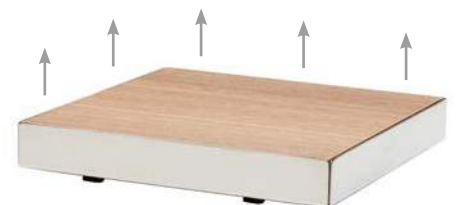
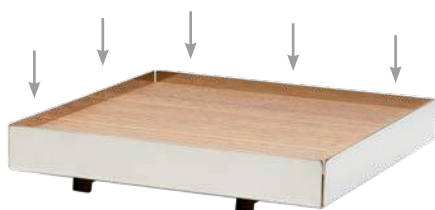

Minimal
Versatile
Modulare
Creativo
Trendy

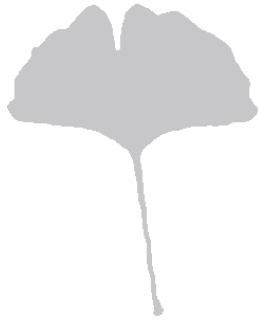

For a versatile and creative food presentation

in different moments of the day - from breakfast to aperitives, from dinner to food design, a perfect mixture of elements meant for stylish and trendy bars and restaurants. A synthesis of the new vision of the plain and elegant presentation for the most demanding chefs' creations. A simple and fanciful game of valuable materials, modular and interchangeable components.

Pour une présentation culinaire à usage multiple

et créative à différents moments de la journée du petit-déjeuner à l'apéritif, du dîner à la démonstration culinaire - un parfait mélange d'éléments pour bars et restaurants stylés et branchés. Une synthèse de la nouvelle vision de la présentation simple et élégante des créations des chefs les plus exigeants. Un jeu simple et inventif associant des composants de valeur, modulables et interchangeables.

Para una presentación de los alimentos versatil

y creativa en los diferentes momentos del día - desde el desayuno al aperitivo, de la cena al food design, una combinación perfecta de elementos pensados para locales sofisticados y de diseño. Una síntesis de las nuevas visiones del servicio minimalista y elegante para las creaciones de los chefs más exigentes. Un juego simple y original de componentes de materiales preciados, modulares e intercambiables.

Für eine vielseitige und kreative Präsentation der

Speisen zu unterschiedlichen Tageszeiten vom Frühstück bis zum Aperitif, vom Dinner bis zum Anrichten der Speisen, eine perfekte Mischung verschiedener Elemente gedacht für trendige Bars und Restaurants. Eine Kombination neuer Möglichkeiten einer schlichten und einfachen Präsentation der anspruchsvollen Kreationen der Chefköche. Eine einfache und doch fantasievolle Art hochwertige Materialien, Module und auswechselbare Komponenten zu kombinieren.

Ginco

Food design

Per una presentazione del cibo versatile e creativa

in momenti diversi della giornata, dalla colazione all'aperitivo, dalla cena a servizi di food design. Una combinazione perfetta di elementi pensati per locali sofisticati e di tendenza. Una sintesi della nuova visione del servizio minimal ed elegante per le creazioni degli chefs più esigenti. Un gioco semplice ed estroso di componenti dai materiali pregiati, modulari ed intercambiabili.



322 04 00 A11 - Whisky
10x20 Cm



322 04 00 A08 - Brandy
10x20 Cm



322 04 00 A07 - Sherry
10x20 Cm



322 04 00 A05
10x20 Cm



322 04 00 A01
10x20 Cm



322 04 00 A10
10x30 Cm



322 04 00 A06
10x30 Cm



322 04 00 A21
20x30 Cm



322 04 00 A22
5x20 Cm



322 04 00 A20
10x20 Cm



322 04 00 A23
10x30 Cm



322 04 00 A24
10x30 Cm



322 04 00 A27
10x20 Cm



322 04 00 A28
10x20 Cm



322 04 00 A29
10x20 Cm



322 04 00 A25
10x20 Cm

322 04 00 A26
10x20 Cm





322 04 00 A63
10x20 Cm



322 04 00 A28
10x20 Cm



322 04 00 A61
10x20 Cm



322 04 00 A60
5x20 Cm



322 04 00 A33
10x30 Cm



322 04 00 A34
10x20 Cm



322 04 00 A37
10x20 Cm



322 04 00 A31
10x20 Cm



322 04 00 A32
10x20 Cm



322 04 00 A70
10x20 Cm



322 04 00 A72
10x10 Cm



322 04 00 A73
5x20 Cm



322 04 00 A74
5x20 Cm



322 04 00 A22
5x20 Cm

Dressing & Vinaigrette



322 04 00 A52

10x20 Cm



322 04 00 A50

10x10 Cm



322 04 00 A51

10x20 Cm



322 04 00 A54

10x20 Cm



322 04 00 A53

10x20 Cm

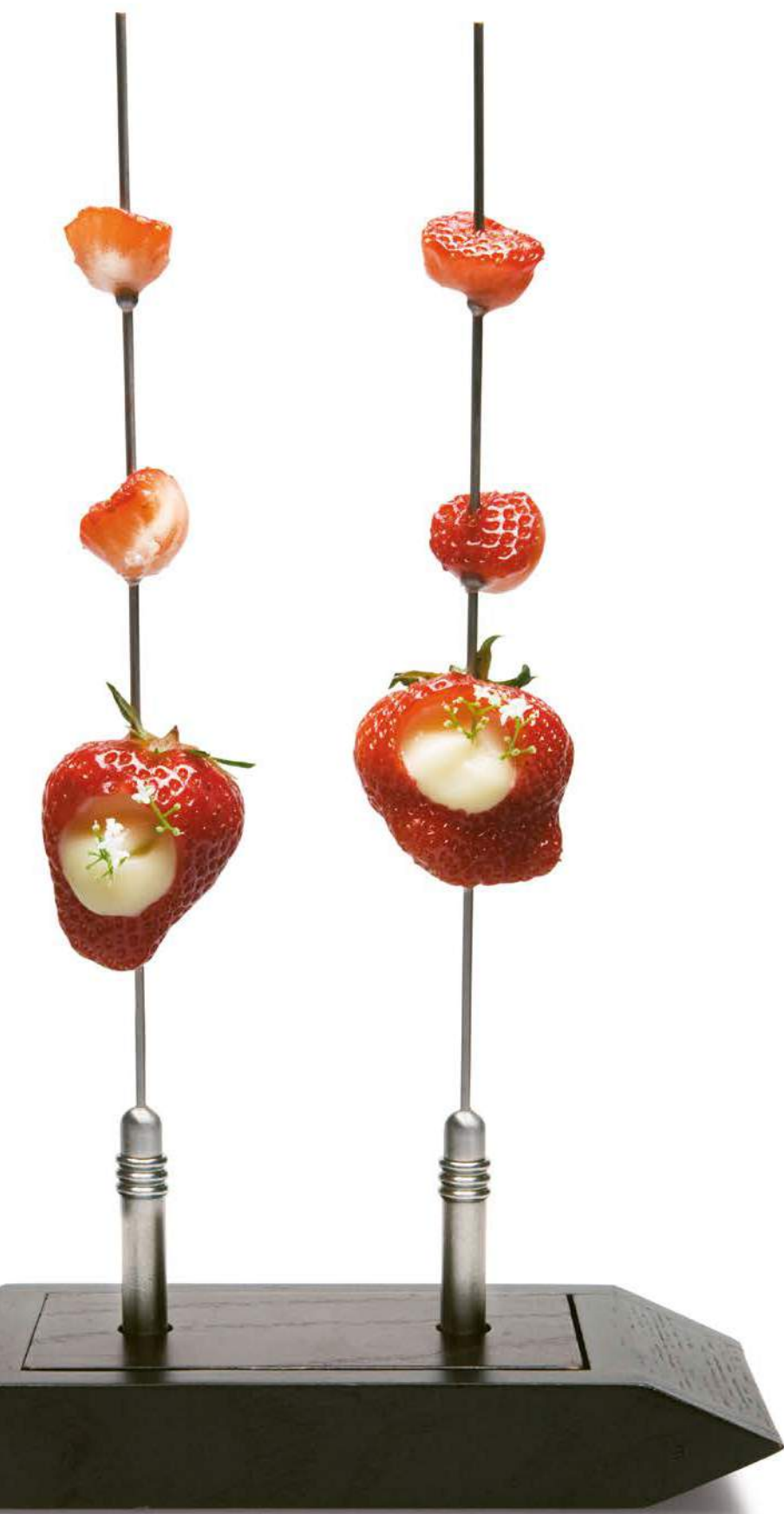

322 04 00 A65
5x10 Cm



322 04 00 A66
10x20 Cm



322 04 00 A67
10x20 Cm



322 04 00 A68
10x20 Cm



322 04 00 A80
10x20 Cm



322 04 00 A81
5x20 Cm



322 04 00 A82
5x20 Cm



322 04 00 A84
10x20 Cm



322 04 00 B04
32,5x54 Cm



322 04 00 B01
32,5x53 Cm



322 04 00 B03
32,5x53 Cm



322 04 00 B06
32,5x53 Cm



322 04 00 B07
32,5x53 Cm



322 04 00 B05
32,5x53 Cm



322 04 00 B02
32,5x53 Cm

Ginco

dà libero spazio alla creatività degli chefs per infinite soluzioni di presentazione.

Gli elementi

vassoi (roots), inserti (leaves) ed accessori - dai materiali pregiati (legno ed acciaio prodotti in Italia; vetro, porcellana e pietra prodotti in Europa) sono modulari ed intercambiabili.

I componenti

- Vassoi (roots) in legno
- Inserti (leaves) in legno
- Accessori in acciaio, vetro, porcellana, pietra

Modularità

La misura di ogni inserto (leaf) è sempre multiplo di 5 Cm, adattandosi a tutti i vassoi (roots) ed a qualsiasi tipo di combinazione.

- Ogni inserto (leaf) ha due facce per usi diversi
- Tutti gli accessori in acciaio sono montati su di un unico supporto
- Gli accessori in vetro ed in porcellana vengono posizionati in basi di diametro differente direttamente nella sede
- Le pietre vengono posizionate direttamente sul vassoio (root)

Ginco

da libre espacio a la creatividad de los chefs para infinitas soluciones de presentaciones.

Los elementos

bandejas (roots), complementos (leaves) y accesorios - de materiales preciados (madera y acero producido en Italia; vidrio, porcelana y piedra producidos en Europa) son modulares y intercambiables.

Los componentes

- para combinar son
- Bandejas (roots) en madera
- Complementos (leaves) en madera
- Accesorios en acero, vidrio, porcelana, piedra.

Modulación

La medida de cada complemento (leaf) es siempre múltiple de 5 Cm, adaptándose a todos las bandejas (roots) y a cualquier tipo de combinación.

- Cada complemento (leaf) tiene dos lados para usos diversos.
- Todos los accesorios en acero estan montados encima de un único soporte.
- Los accesorios en vidrio y porcelana vienen colocados de acuerdo con el diametro diferente directamente en su ubicación.
- Las piedras van colocadas directamente en la bandeja (root).

Ginco

gives complete freedom to the chefs' creativity for infinite presentation solutions.

The elements

trays (roots), inserts (leaves) and accessories - are made of valuable materials (wood and steel manufactured in Italy; glass and stone manufactured in Europe) are modular and interchangeable.

The components

- to be matched are
- Wooden trays (roots)
- Wooden inserts (leaves)
- Steel, glass, porcelain and stone accessories

Modularity

Each insert (leaf) size is always multiple of 5 Cm, matching with all the trays (roots) and to any combination.

- Each insert (leaf) has two sides for different uses
- All the steel accessories are assembled on one single stand
- The glass and porcelain accessories are placed in bases with different diameter in the seat directly
- The stones are placed in the tray (root) directly

Ginco

ermöglicht den Chefköchen ungeahnten Freiraum bei der Präsentation ihrer Kreationen und bietet dabei unendliche Möglichkeiten.

Die Elemente

Tablets, Einsätze und Accessoires - sind aus hochwertigen Materialien (Holz und Edelstahl werden in Italien hergestellt; Glas und die Steine stammen aus Europa) sind modular und austauschbar.

Folgende Elemente

- lassen sich miteinander verbinden:
- Holztablets
- Holzeinsätze
- Edelstahl-, Glas, Porzellan und Steinaccessoires.

Baukastenprinzip

Jeder Einsatz bzw. seine Größe lässt sich um 5cm variieren, so dass er sich mit allen Tablets in jeder Kombination verbinden lässt.

- Jeder Einsatz hat zwei unterschiedlich und für verschiedene Zwecke geeignete Seiten
- Alle Stahlaccessoires werden auf nur einer Halterung zusammengebaut.
- Die Glas- und Porzellanaccessoires werden in die Basis mit unterschiedlichem Durchmesser eingesetzt.
- Die Steinplatten werden direkt in die Tablets eingesetzt.

Ginco

laisse la créativité du chef s'exprimer en toute liberté au moyen de solutions de présentation infinies.

Les objets

plateau (roots), implants (leaves) et les accessoires - sont constitués de matériaux de grande valeur (du bois et de l'acier travaillés en Italie; le verre et la pierre sont façonnés en Europe) et sont modulables et interchangeables.

Les éléments

- à combiner sont les suivants:
- Plateaux (roots) en bois
- Implants (leaves) en bois
- Des accessoires en acier, en porcelaine, en verre et les pierres

Modulabilité



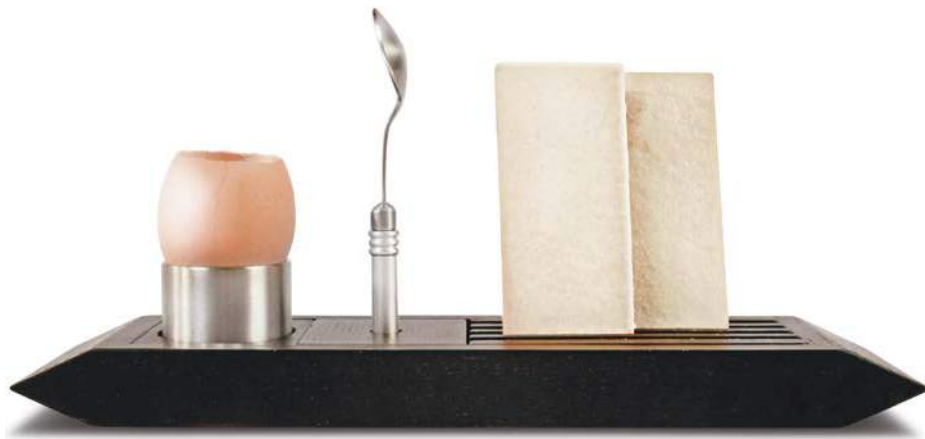

La taille de chaque implant (leaf) est toujours un multiple de 5 Cm, s'adaptant à tous les plateaux et à toutes les combinaisons.

- chaque implant (leaf) a deux côtés pour les différents besoins
- tous les accessoires en acier sont réunis en un seul ensemble
- les accessoires en verre et en porcelaine sont placés dans divers compartiments avec des différents diamètres, directement au niveau du siège
- Les pierres sont placées directement sur le plateau (roots)



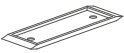
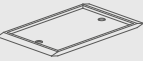

WENGE TRAYS | VASSOIO WENGE

| | | | |
|---|------------------------------------|-------------|---------------|
|  | ROOT "II" Vassoio "Root II" | 6,7x16,5 Cm | 322 04 23 815 |
|  | ROOT "III" Vassoio "Root III" | 10x10 Cm | 322 04 23 816 |
|  | ROOT "V" Vassoio "Root V" | 10x20 Cm | 322 04 23 810 |
|  | ROOT "VI" Vassoio "Root VI" | 5x20 Cm | 322 04 23 811 |
|  | ROOT "VII" Vassoio "Root VII" | 10x30 Cm | 322 04 23 817 |
|  | ROOT "VIII" Vassoio "Root VIII" | 20x30 Cm | 322 04 23 812 |

WENGE INSERTS FOR TRAYS | INSERTI WENGE PER VASSOI

| | | | |
|---|--|----------|---------------|
|  | LEAF "ONE I" Inserto "Leaf One I" | 5x5 Cm | 322 04 54 547 |
|  | LEAF "ONE II" Inserto "Leaf One II" | 5x5 Cm | 322 04 54 548 |
|  | LEAF "ONE III" Inserto "Leaf One III" | 5x5 Cm | 322 04 54 549 |
|  | LEAF "TWO I" Inserto "Leaf Two I" | 5x10 Cm | 322 04 54 551 |
|  | LEAF "TWO II" Inserto "Leaf Two II" | 5x10 Cm | 322 04 54 552 |
|  | LEAF "TWO III" Inserto "Leaf Two III" | 5x10 Cm | 322 04 54 553 |
|  | LEAF "TWO IV" Inserto "Leaf Two IV" | 5x10 Cm | 322 04 54 554 |
|  | LEAF "TWO V" Inserto "Leaf Two V" | 5x10 Cm | 322 04 54 555 |
|  | LEAF "TWO VI" Inserto "Leaf Two VI" | 5x10 Cm | 322 04 54 574 |
|  | LEAF "THREE I" Inserto "Leaf Three I" | 10x10 Cm | 322 04 54 556 |
|  | LEAF "THREE II" Inserto "Leaf Three II" | 10x10 Cm | 322 04 54 557 |



| | | | |
|---|--|----------|---------------|
|  | LEAF "THREE III" Inserto "Leaf Three III" | 10x10 Cm | 322 04 54 558 |
|  | LEAF "THREE IV" Inserto "Leaf Three IV" | 10x10 Cm | 322 04 54 559 |
|  | LEAF "THREE VI" Inserto "Leaf Three VI" | 10x10 Cm | 322 04 54 616 |
|  | LEAF "THREE VII" Inserto "Leaf Three VII" | 10x10 Cm | 322 04 54 562 |
|  | LEAF "FIVE I" Inserto "Leaf Five I" | 10x20 Cm | 322 04 54 563 |
|  | LEAF "FIVE II" Inserto "Leaf Five II" | 10x20 Cm | 322 04 54 564 |
|  | LEAF "FIVE III" Inserto "Leaf Five III" | 10x20 Cm | 322 04 54 565 |
|  | LEAF "FIVE IV" Inserto "Leaf Five IV" | 10x20 Cm | 322 04 54 566 |
|  | LEAF "FIVE VI" Inserto "Leaf Five VI" | 10x20 Cm | 322 04 54 568 |
|  | LEAF "FIVE VII" Inserto "Leaf Five VII" | 10x20 Cm | 322 04 54 569 |
|  | LEAF "SIX V" Inserto "Leaf Six V" | 5x20 Cm | 322 04 54 591 |

STAINLESS STEEL ACCESSORIES | ACCESSORI IN ACCIAIO INOX



| | | | |
|---|---|----------|---------------|
|  | MULTIPURPOSE HOLDER Manico Supporto Universale | 4,3 Cm | 322 05 91 788 |
|  | SKEWER Spiedino | 7,1 Cm | 322 05 91 789 |
|  | LONG SKEWER WITH BALLS Spiedino 3 Sfere | 20,8 Cm | 322 05 91 784 |
|  | SPIRAL Spirale | ø 4 Cm | 322 05 91 787 |
|  | COOKIE HOLDER Portacioccolato | ø 3,8 Cm | 322 05 43 605 |
|  | PHIAL HOLDER Portafiale | ø 2,2 Cm | 322 05 17 520 |
|  | GLASS HOLDER Portabicchiere | ø 4 Cm | 322 05 21 536 |

| | | | |
|---|-------------------------------------|--------|---------------|
|  | MOKA SPOON Cucchiaio Moka | 6,7 Cm | 322 05 81 694 |
|  | TWO-PRONG FORK Forchetta 2 Punte | 7,3 Cm | 322 05 81 695 |
|  | CONE HOLDER Portacono | 9,5 Cm | 322 05 91 790 |

GLASS ACCESSORIES | ACCESSORI IN VETRO

| | | | |
|---|--|-------------------|---------------|
|  | PHIAL Fiala | ø 2 H. 5 Cm | 322 08 17 528 |
|  | PHIAL Fiala | ø 2 H. 10 Cm | 322 08 17 529 |
|  | PHIAL Fiala | ø 2 H. 15 Cm | 322 08 17 521 |
|  | MEDIUM GLASS Bicchiere Medio | ø 3,2 H. 5 Cm | 322 08 17 522 |
|  | BIG GLASS Bicchiere Grande | ø 4 H. 4,5 Cm | 322 08 17 524 |
|  | BIG GLASS BOWL Ciotola Grande | ø 7 H. 5,5 Cm | 322 08 43 607 |
|  | LIQUEUR GLASS Bicchiere Distillato | H. 8,3 Cm 5,5 cl. | 322 08 17 525 |
|  | OIL BOTTLE Dispenser per olio | ø 7 H. 9,5 Cm | 322 08 11 620 |
|  | WHISKY GLASS Bicchiere Whisky | 42 cl. | 322 08 17 530 |
|  | COGNAC GLASS Bicchiere Cognac | 55 cl. | 322 08 17 531 |
|  | CHAMPAGNE FLUTE Flute Champagne | 25 cl. | 322 08 17 532 |
|  | CHAMPAGNE FLUTE "BROGGI" Flute Champagne "Broggi" | 19 cl. | 404 60 44 190 |
|  | WINE GLASS "BROGGI" Bicchiere Vino "Broggi" | 25 cl. | 404 60 44 250 |
|  | TUMBLER "BROGGI" Tumbler "Broggi" | 23 cl. | 402 50 15 230 |
|  | TUMBLER "CUBE" Tumbler "Cube" | 23 cl. | 402 61 76 230 |



| | | | |
|---|--------------------|-----------------|---------------|
|  | GLASS Bicchiere | ø 43 H. 57 mm. | 406 13 11 028 |
|  | GLASS Bicchiere | ø 40 H. 105 mm. | 406 11 05 820 |
|  | GLASS Bicchiere | ø 60 H. 70 mm. | V86 08 42 BBA |



STONE SLATES, OVENPROOF | PIASTRA IN PIETRA (ADATTA AL FORNO)

| | | | |
|--|-----------------|----------|---------------|
|  | SLATE Pietra | 10x10 Cm | 322 22 71 968 |
|  | SLATE Pietra | 10x20 Cm | 322 22 71 969 |
|  | SLATE Pietra | 10x30 Cm | 322 22 71 973 |
|  | SLATE Pietra | 5x10 Cm | 322 22 71 971 |

PORCELAIN ACCESSORIES | ACCESSORI IN PORCELLANA

| | | | |
|---|---|-------------------|---------------|
|  | CUP Tazza s/manico | ø 7,5 Cm | 322 21 43 608 |
|  | SQUARE PLATE Piatto Quadrato | 10x10 Cm | 322 21 22 691 |
|  | SAUCE BOWL Portasalse s/coperchio | H. 3,7x5,5x7,2 Cm | 322 21 09 559 |
|  | COVER FOR SAUCE BOWL Coperchio/Sottocoppa Portasalse | 5,5x7,2 Cm | 322 21 09 560 |
|  | APPETIZER Appetizer | 11x3,2 Cm | 322 21 81 697 |
|  | SUITE ESPRESSO CUP Tazza Espresso Suite | 12 cl. | 322 21 43 610 |
|  | SUITE TEA CUP Tazza Tè Suite | 22 cl. | 322 21 43 613 |
|  | SALT BOWL Portasale | ø 48 mm. | 322 21 43 614 |
|  | BROGGI COFFEE CUP - STACKABLE Tazza Espresso Sovrapponibile Broggi | 8 cl. | 241 02 01 451 |
|  | OLIVE OIL BOWL Portaolio / Burro | ø 70 mm. | V87 21 42 005 |

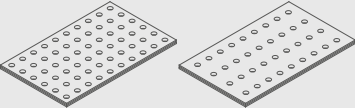
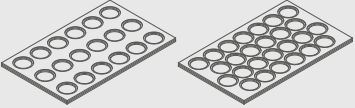

| | | | |
|---|---|---------------------|----------------------|
|  | <p>ROOT "X" Vassoio Root "X"</p> | <p>32,5x53,5 Cm</p> | <p>322 04 23 814</p> |
|  | <p>LEAF "THIRTEEN IV" Inserto "Thirteen IV"</p> | <p>32,5x53,5 Cm</p> | <p>322 04 54 585</p> |
|  | <p>LEAF "THIRTEEN V" Inserto "Thirteen V"</p> | <p>32,5x53,5 Cm</p> | <p>322 04 54 586</p> |
|  | <p>LEAF "THIRTEEN VI" Inserto "Thirteen VI"</p> | <p>32,5x53,5 Cm</p> | <p>322 04 54 587</p> |
|  | <p>LEAF "THIRTEEN VII" Inserto "Thirteen VII"</p> | <p>32,5x53,5 Cm</p> | <p>322 04 54 588</p> |
|  | <p>LEAF "THIRTEEN VIII" Inserto "Thirteen VIII"</p> | <p>32,5x53,5 Cm</p> | <p>322 04 54 589</p> |
|  | <p>LEAF "SEVEN V" Inserto "Seven V"</p> | <p>10x30 Cm</p> | <p>322 04 54 596</p> |
|  | <p>LEAF "TWELVE VII" Inserto "Twelve VII"</p> | <p>30x40 Cm</p> | <p>322 04 54 603</p> |
|  | <p>LEAF "TWELVE X" Inserto "Twelve X"</p> | <p>30x40 Cm</p> | <p>322 04 54 593</p> |



GINCO, UN PRODOTTO NATURALE

Materiale

Vassoi (roots) ed inserti (leaves) sono in legno massiccio, un materiale vivo e caldo, che conferisce pregio e valore al prodotto. Il legno è anche un materiale morbido e questo richiede una particolare cura nella manutenzione e nella conservazione. Una corretta manutenzione ne prolunga considerevolmente la durata.

Caratteristiche

Il legno è sensibile alla luce, all'aria, alla temperatura ed all'umidità. Sugeriamo di non esporre Ginco alla luce solare, ad alte o basse temperature e di non conservarlo in ambienti umidi.

Manutenzione

Per la pulizia suggeriamo l'utilizzo di un panno morbido e pulito. Per rimuovere tracce di sporcizia può essere utilizzato un panno inumidito.

Danneggiamento

A causa di un utilizzo prolungato e per le sue naturali caratteristiche, il legno può graffiarsi. Per ammorbidire i graffi e riparare lievi danneggiamenti, consigliamo l'utilizzo del kit per il ritocco (REPAIR KIT - codice 3220400KIT) - composto da una bottiglietta di vernice ed un pennellino - che forniamo unitamente a Ginco. E' sufficiente verniciare la parte danneggiata con il pennellino, in modo da ricolorare il legno.

Il legno è un prodotto naturale; lievi variazioni di colore e struttura da un prodotto all'altro possono verificarsi.

GINCO, UN PRODUIT NATUREL

Matériau

Les plateaux (roots) et les encarts (leaves) sont en bois massif, un matériau chaud et vivant, qui donne de la qualité et de la valeur au produit. Le bois est aussi un matériau moelleux et ceci demande un soin particulier pour son entretien et sa conservation. Un entretien correct en prolonge considérablement la durée.

Caractéristiques

Le bois est sensible à la lumière, à l'air, à la température et à l'humidité. Nous suggérons de ne pas exposer Ginco à la lumière du soleil, à des hautes ou basses températures et de ne pas le conserver dans des lieux humides.

Entretien

Pour le nettoyage, nous suggérons l'utilisation d'un chiffon moelleux et propre. Pour ôter les traces de saleté on peut utiliser un chiffon humide.

Endommagement

À cause d'une utilisation prolongée et de ses caractéristiques naturelles, le bois peut se griffer. Pour assouplir les griffes et réparer des dommages légers, nous conseillons l'utilisation du kit pour les retouches (REPAIR KIT - code 3220400KIT) - composé d'une petite bouteille de peinture et d'un pinceau - que nous fournissons avec Ginco. Il suffit de peindre la partie endommagée avec le pinceau, de façon à recolorer le bois.

Le bois est un produit naturel; des légères variations de couleur et de structure d'un produit à l'autre peuvent se vérifier.

GINCO, A NATURAL PRODUCT

Material

Trays (roots) and inserts (leaves) are made of hardwood, which is a lively and warm material, and provides worth and value to the product. Wood is also a soft material, which requires extra care in maintenance and storage. A correct maintenance considerably prolongs its life span.

Characteristics

Wood is susceptible to light, air, temperature and humidity. We suggest not to expose Ginco to sunlight, high or low temperatures and to store in moist surroundings.

Maintenance

In order to clean it we suggest to use a soft, dry cloth. In order to remove minor filthiness, a slightly dampened cloth may be used.

Damage

Through intensive use and because of its natural softness, wood may show scratches: in order to cover scratches and minor damages, we suggest to use the enclosed retouch kit (REPAIR KIT - code 3220400KIT) - including a small bottle of varnish and a small brush. You must simply paint the damage with the small brush, in order to re-colour the wood.

Wood is a natural product; slight colour and structural variations from one product to another may occur.

GINCO, UN PRODUCTO NATURAL

Material

Azafates (raíces) e insertos (hojas) son de madera maciza, un material vivo y cálido, que confiere prestigio y valor al producto. La madera también es un material blando y por ello requiere un cuidado particular en el mantenimiento y conservación. Un mantenimiento correcto prolonga considerablemente su duración.

Características

La madera es sensible a la luz, al aire, a la temperatura y a la humedad. Sugerimos no exponer Ginco a la luz solar, a altas o bajas temperaturas y no conservarlo en lugares húmedos.

Mantenimiento

Para la limpieza sugerimos el empleo de un paño suave y limpio. Para eliminar rastros de suciedad se puede utilizar un paño humedecido

Deterioro

A raíz de un empleo prolongado y por sus características naturales, la madera puede arañarse. Para suavizar los arañazos y reparar pequeños daños, sugerimos el empleo del kit para el retoque (REPAIR KIT - código 3220400KIT) - compuesto por una botellita de barniz y un pequeño pincel - que suministramos junto con Ginco. Es suficiente barnizar la parte deteriorada con el pincelito, para volver a colorear la madera.

La madera es un producto natural; pueden verificarse ligeras variaciones de color y de estructura de un producto a otro.

GINCO - EIN NATURPRODUKT

Werkstoff

Tablets und Fächer sind aus Massivholz, ein lebendiges und warmes Material, das dem Produkt Eigen- und Mehrwert verleiht. Holz ist allerdings auch ein weiches Produkt, was besondere Sorgfalt bei der Pflege und Instandhaltung erfordert - zumal die richtige Pflege die Lebensdauer von Holz erheblich verlängert.

Merkmale

Holz reagiert empfindlich auf Licht, Luft, Temperatur und Feuchtigkeit. Wir empfehlen, Ginkgo Holz nicht direktem Sonnenlicht, hohen oder niedrigen Temperaturen auszusetzen und es nicht in feuchten Räumen aufzubewahren.

Pflege und Instandhaltung

Zur Reinigung empfehlen wir, einen sauberen weichen Lappen zu benutzen. Schmutzspuren können auch mit einem feuchten Lappen entfernt werden.

Schäden

Bei längerer Benutzung und aufgrund seiner natürlichen Charakteristiken kann Holz Kratzer aufweisen. Um Kratzer zu mildern und leichte Schäden zu beheben, empfehlen wir den Einsatz des Kits aus dem Lieferumfang (REPAIR KIT - Kode Nr. 32204003T): ein Fläschchen Flüssiglack und ein Pinsel; damit können schadhafte Stellen lackiert und der Holzton allgemein aufgefrischt werden.

Holz ist ein Naturprodukt, das von einem Exemplar zum anderen leichte Farb- und Strukturunterschiede aufweisen kann.





Zeta

Acciaio - 18/10 St. Steel



Zeta

Caffettiera

Coffee pot
Cafetière
Cafetera
Kaffeekanne

| | Cl | Oz |
|---------------|-----|----|
| 305 05 01 611 | 30 | 10 |
| 305 05 01 612 | 60 | 20 |
| 305 05 01 613 | 90 | 30 |
| 305 05 01 614 | 150 | 53 |



Cremiera

Creamer
Crémier
Lechera
Milchgießer

| | Cl | Oz |
|---------------|----|----|
| 305 05 03 621 | 15 | 6 |
| 305 05 03 622 | 30 | 10 |
| 305 05 03 623 | 60 | 20 |
| 305 05 03 624 | 90 | 30 |





Teiera

Teapot
Théière
Tetera
Teekanne

| | Cl | Oz |
|---------------|-----|------|
| 305 05 02 578 | 40 | 13,5 |
| 305 05 02 579 | 60 | 20 |
| 305 05 02 580 | 100 | 35 |

Brocca acqua

Water pitcher
Carafe à eau
Jarra agua
Wasserkrug

| | Cl | Oz |
|---------------|-----|----|
| 305 05 08 543 | 150 | 53 |



Porta cucchiaini

Tea spoon holder
Porte-petites cuillères
Porta cucharitas café
Löffelbehälter

| | H. Cm | H. In. |
|---------------|-------|--------|
| 305 05 71 975 | 8,5 | 3,3/8 |



Zuccheriera

Sugar bowl
Sucrier
Azucarero
Zuckerdose

| | H. Cm | H. In. |
|---------------|-------|--------|
| 305 05 04 584 | 6,2 | 2,3/8 |



Spargisale e spargipepe

Salt and pepper shakers
Salière et poivrier
Salero y pimentero
Salz-und Pfefferstreuer

| | H. Cm | H. In. |
|---------------|-------|--------|
| 305 05 12 619 | 5,2 | 2 |
| 305 05 12 620 | 5,2 | 2 |



Portastecchi

Toothpick holder
Porte cure-dents
Palillero
Zahnstocherhalter

| | H. Cm | H. In. |
|---------------|-------|--------|
| 305 05 11 621 | 5,2 | 2 |

Portabustine zucchero/tè

Sugar/tea bag holder
Porte-sachets de thé/sucre
Porta sobres de té/azúcar
Zucker/Teebeuteln

| | Cm | H. Cm | In. | H. In. |
|---------------|------------|-------|---------------|--------|
| 305 05 04 585 | 11,8 x 6,3 | 4,0 | 4,4/3 x 2,1/2 | 1,1/2 |



Burriera

Butter dish
Beurrier
Mantequera
Butterdose

| | ø Cm | H. Cm | ø In. | H. In |
|---------------|----------|-------|---------|-------|
| 305 05 09 561 | 10,5x7,5 | 5 | 4,1/8x3 | 2 |



Coppa multiuso

Multipurpose bowl
Coupe multi-usage
Bol multiuso
Universalschale

| | Cm | H. Cm | In. | H. In |
|---------------|---------|-------|-----------|-------|
| 305 05 43 614 | 13 x 10 | 5,3 | 5,1/8 x 4 | 2,1/8 |



Salsiera doppio becco

Double-spout sauce boat
Saucière à double bec
Salsera doble pico
Sauciere Ausguß beids

| | Cm | H. Cm | In. | H. In |
|---------------|---------|-------|-----------|-------|
| 305 05 12 624 | 16 x 10 | 5,4 | 6,1/4 x 4 | 2,1/8 |



Zeta

Servitore tè/pasticceria acciaio inox

Afternoon-tea stand

Support pour service à thé

Soposte expositor platos postre

Teller-Etagere

| | Cm | H. Cm |
|-------------------------------|------|-------|
| 305 05 42 598 | 30 | 40 |
| per piatti/for dishes ø Cm 25 | | |
| 305 05 42 599 | 31,4 | 41,1 |
| per piatti/for dishes ø Cm 30 | | |



Portavasetti marmellata

4-jar jam holder

Porte-confiture pour 4 pots

Dispensador de mermelada para 4 botes

Konfitüreschale 4-tlg

| | ø Cm (foro) | ø In. (foro) |
|---------------|-------------|--------------|
| 305 05 09 562 | 4,5 | 1,3/4 |
| 305 05 09 563 | 5,8 | 2,3/8 |



Lampada da tavolo

Table lamp

Lampe à bougie

Lâmpara de mesa

Tischlampe

| | H. Cm | H. In | |
|---------------|-------|-------|-------|
| 305 05 17 532 | 16 | 6,1/4 | Clear |
| 305 05 17 535 | 16 | 6,1/4 | Grey |





Candeliera 1 luce

Candlestick, 1-light
Flambeau 1 lumière
Candelerio 1 luz
1-armig, Leuchter

| | H. Cm | H. In |
|---------------|-------|-------|
| 305 05 18 560 | 15,5 | 6,1/8 |



Candelabro 3 luci

Candelabrum, 3-light
Candélabre 3 lumières
Candelabro 3 luces
3-armig, Kerzenleuchter

| | H. Cm | H. In |
|---------------|-------|--------|
| 305 05 18 561 | 46,5 | 18,1/4 |



Candelabro 5 luci

Candelabrum, 5-light
Candélabre 5 lumières
Candelabro 5 luces
5-armig, Kerzenleuchter

| | H. Cm | H. In |
|---------------|-------|--------|
| 305 05 18 562 | 46,5 | 18,1/4 |



Vassoio con portabustine

Tray with sugar/tea bag holder
 Plateau avec porte-sachets thé/sucre
 Bandeja con porta sobres de tè/azúcar
 Tablett mit Zuck./Teebeuteln

| | | |
|---------------|-----------|---------------|
| | Cm | In |
| 305 05 04 586 | 21 x 13,5 | 8,1/4 x 5,3/8 |

Vassoio accessori colazione

Breakfast accessories tray
 Plateau accessoires à petit déjeuner
 Bandeja accesorios desayuno
 Tablett mit Frühstückzubehör

| | | |
|---------------|-----------|---------------|
| | Cm | In |
| 305 05 23 823 | 21 x 13,5 | 8,1/4 x 5,3/8 |



Vassoio rendiresto

Change tray
 Plateau porte-monnaie
 Bandeja portamoneda
 Geldwechsellablett

| | | |
|---------------|-----------|---------------|
| | Cm | In |
| 305 05 23 809 | 21 x 13,5 | 8,1/4 x 5,3/8 |



Cod. ...05 Acciaio - 18/10 St.Steel
Cod. ...07 Acciaio Argentato - EPSS

Zeta



Cestino pane ovale ad anelli

Ring oval bread basket
Corbeille à pain à anneaux
Cesta pan aros
Brotkorb

| | Cm | In |
|---------------|-------------|-----------|
| 305 05 24 566 | 16,2 x 12,7 | 6,1/4 x 5 |

Barchetta gourmet

Gourmet boat
Corbeille à pain gourmet
Cesta pan gourmet
Gourmetschale

| | Cm | In |
|---------------|---------|------|
| 305 05 24 561 | 33 x 10 | 13,4 |



Cestino pane

Bread basket
Corbeille à pain
Cesta pan
Brotkorb

| | Cm | In |
|---------------|---------|----------------|
| 305 05 24 560 | 30 x 16 | 11,3/4 x 6,1/4 |



Glacette

Glacette
Rafraîchisseur de bouteille
Enfriador de botellas
Weinkühler

| | Cm | H. Cm | In | H. In |
|---------------|-------------|-------|---------------|-------|
| 305 05 24 559 | 14,5 x 10,5 | H. 22 | 5,3/4 x 4,1/8 | 8,5/8 |



Secchio ghiaccio

Ice bucket
Seau à glace
Cubo hielo
Eiswürfelbehälter

| | Cm | H. Cm | In | H. In |
|---------------|-----------|-------|-----------|-------|
| 305 05 20 667 | 16 x 12,5 | 16,5 | 6,1/4 x 5 | 6,1/2 |



Secchio champagne

Champagne bucket
Seau à champagne
Champañera
Sektkühler

| | Cm | H. Cm | In | H. In |
|---------------|---------|-------|-----------|-------|
| 305 05 20 666 | 19 x 15 | 19,5 | 7,1/2 x 6 | 7,5/8 |



Brocca acqua

Water pitcher
Carafe à eau
Jarra agua
Wasserkrug

| | Cl | H. Cm | H. In |
|---------------|-----|-------|-------|
| 305 05 08 543 | 150 | 19,5 | 7,5/8 |



Colonna secchio champagne

Champagne bucket stand
Support pour seau à champagne
Soporte champañera
Sektkühlerständer

| | H. Cm | H. In |
|---------------|-------|--------|
| 305 05 20 668 | 59,5 | 23,1/2 |



Vassoio rettangolare KOKU in acciaio inossidabile

Koku rectangular tray
Plateau rectangulaire Koku
Bandeja rectangular Koku
Koku Tablett rechteckig

| | Cm | In |
|---------------|---------|-----------------|
| 381 05 23 803 | 42 x 29 | 16,1/2 x 11,1/2 |



Servipasta / risottiera / fruttiera KOKU in acciaio inossidabile

Koku pasta/risotto/fruit dish
Plat à pasta/risotto/fruit Koku
Fuente para pasta/risotto/frutas Koku
Koku Pasta/Risottoschale

| | Cm | In |
|---------------|---------|-----------------|
| 381 05 54 542 | 42 x 29 | 16,1/2 x 11,1/2 |

Pirofila Koku per servipasta in Porcellana

Oven-prof dish Koku Porcelain
Plat en pyrex Koku en Porcelaine
Fuente para horno/pasta en Porcelana
Porzellanschale rech. ofenfest für Koku Tablett

| | Cm | In |
|---------------|---------|--------|
| 381 21 54 543 | 33 x 23 | 13 x 9 |



Tovaglietta KOKU in acciaio inossidabile

Koku placemat
Set de table Koku
Mantel individual Koku
Koku Platzteller

| | Cm | In |
|---------------|---------|-------------|
| 381 05 25 538 | 43 x 31 | 17 x 12,1/4 |



Vassoio quadrato KOKU in acciaio inossidabile

Koku square tray
Plateau carré Koku
Bandeja cuadrada Koku
Koku Tablett

| | Cm | In |
|---------------|---------|-----------------|
| 381 05 23 802 | 31 x 31 | 12,1/4 x 12,1/4 |



Piatto presentazione KOKU

Koku show plate
Plat de présentation Koku
Plato de presentación Koku
Koku Ausstellplatte

| | Cm | In |
|---------------|---------|-----------------|
| 381 05 25 537 | 31 x 31 | 12,1/4 x 12,1/4 |



Insalatiera con vassoio KOKU

Koku salad dish with tray
Saladier avec plateau Koku
Ensaladera con bandeja Koku
Koku Salatschale mit Tablett

| | Cm | In |
|---------------|---------|-------------|
| 381 05 14 518 | 31 x 31 | 17 x 12,1/4 |



**Antipastiera KOKU
con vassoio in acciaio**

Koku hors d'oeuvre dish
Plat à hors d'oeuvre Koku
Entremesera con bandeja Koku
Koku Vorspeisenteller mit Tablett

| | Cm | In |
|---------------|---------|-----------------|
| 381 05 14 519 | 31 x 31 | 12,1/4 x 12,1/4 |



**Piatto pinzimonio / sushi KOKU
in acciaio inossidabile**

Koku raw vegetables/sushi dish
Plat à crudités/sushi avec plateau Koku
Plato verduras crudas/sushi Koku
Koku Sushiteller mit Tablett

| | Cm | In |
|---------------|---------|-----------------|
| 381 05 14 522 | 31 x 31 | 12,1/4 x 12,1/4 |



**Piatto formaggi KOKU
in acciaio inossidabile**

Koku cheese dish
Plat à fromage Koku
Plato para quesos Koku
Koku Käseplatte komplett

| | Cm | In |
|---------------|---------|-----------------|
| 381 05 54 543 | 31 x 31 | 12,1/4 x 12,1/4 |



Iseo

Acciaio - 18/10 St. Steel



Stainless steel hollowware manufacturing process

To make an Iseo coffee pot the first step is to shear the disk (1), that is, a disk of a suitable diameter is cut out of a stainless steel sheet. By means of a die the body is drawn first (2) to get the cylindrical body of the coffee pot; afterwards small spout is flared (3). Once the body is ready, the handle is welded (4). Once the lid is drawn (5), the knob is braze-welded (6) and the lid is coupled to the body with a pin (7). Now the coffee pot is finished. The process ends when the coffee pot is polished (8).

Cycle de production vaisselle en acier inox

Pour la réalisation d'une cafetière Iseo, on part du découpage du disque (1), où, à partir de la tôle, on découpe un disque du diamètre opportun en acier inox. Moyennant un moule, on commence d'abord par l'emboutissage du corps (2) jusqu'à l'obtention du corps cylindrique de la cafetière, et ensuite on procède à la réalisation du bec verseur moyennant évasement (3). Une fois que le corps a été obtenu, on procède à la soudure du manche (4). Après l'emboutissage du couvercle (5), on procède au soudo-brasage du pommeau (6) et au montage au goujon du couvercle au corps (7). À ce point-là, cafetière est complète : la réalisation se termine par le polissage de l'objet (8).

Ciclo de producción de vajilla de acero inoxidable

Para la realización de una cafetera Iseo se comienza por el troquelado del disco (1), con el que en la chapa se corta un disco de acero inoxidable del diámetro oportuno. Mediante un molde se procede primero a la embutición del cuerpo (2) hasta obtener el cuerpo cilíndrico de la cafetera, y luego se procede a la realización del pico mediante abocinamiento (3). Una vez obtenido el cuerpo, se procede a la soldadura del mango (4). Después de la embutición de la tapa (5), se procede a la bronce soldadura del pomulo (6) y al montaje con perno de la tapa al cuerpo (7). A estas alturas la cafetera está completa: la elaboración termina con el abrillantado del objeto (8).

Produktionszyklus von geschirr aus rostfreiem stah

Bei der Anfertigung einer Iseo Kaffeekanne startet man mit dem Schnitt der Scheibe (1), d.h. aus dem Stahlblech wird eine Scheibe von geeignetem Durchmesser ausgeschnitten. Mit Hilfe eines Gesenks erfolgt dann das Tiefziehen des Körpers (2) bis man den Hohlkörper der Kanne erhält, danach wird der Hahn durch Ansenken geformt (3) An dem so erhaltenen Körper wird der Griff durch Weichlöten (4) angebracht Nach Tiefziehen des Deckels (5) wird der Knauf durch Hartlöten angebracht (6) und der Zapfen an Deckel und Körper montiert (7). Jetzt ist die Kaffeekanne fertig und man beginnt mit dem Polieren des Gegenstandes (8).

Acciaio

Fasi di lavorazione

Per la realizzazione di una caffettiera Iseo si parte

dalla tranciatura del disco (1), dove dalla lamiera si va a tranciare un disco del diametro opportuno in acciaio inox. Mediante uno stampo si procede prima con l'imbutitura del corpo (2) fino ad ottenere il corpo cilindrico della caffettiera, e poi si procede con la realizzazione del nasello tramite slabatura (3). Una volta ottenuto il corpo, si procede con la saldatura del manico (4). Dopo l'imbutitura del coperchio (5), si procede con la saldobrasatura del pomolo (6) e con il montaggio con perno del coperchio al corpo (7). A questo punto la caffettiera è completa: la lavorazione termina con la lucidatura dell'oggetto (8).

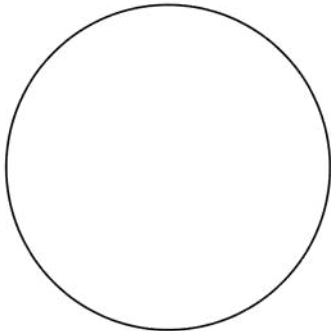

1

Tranciatura disco
Shearing



2

Imbutitura
Drawing

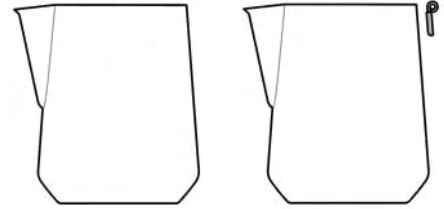

3

Slabratura
Flaring

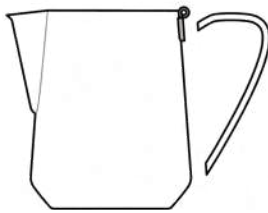

4

Saldatura manico
Handle welding



5

Imbutitura coperchio
Lid drawing



6

Saldobrasatura pomolo
Knob braze-welding



7

Montaggio perno e coperchio
Knob and lid assembly



8

Lucidatura
Polishing

Veneto



Caffettiera Veneto

Veneto coffee pot
Cafetière Veneto
Cafetera Veneto
Kafeekanne Veneto

| | Lt | Oz |
|---------------|------|------|
| 305 05 01 593 | 0,35 | 12 |
| 305 05 01 592 | 0,60 | 21 |
| 305 05 01 594 | 0,90 | 31,5 |
| 305 05 01 595 | 1,50 | 53 |
| 305 05 01 597 | 2,00 | 70 |



Teiera Veneto

Veneto teapot
Theière Veneto
Tetera Veneto
Teekanne Veneto

| | Lt | Oz |
|---------------|------|------|
| 305 05 02 560 | 0,35 | 12 |
| 305 05 02 561 | 0,55 | 19 |
| 305 05 02 562 | 0,88 | 31,3 |



Zuccheriera con coperchio e manici Veneto

Veneto sugar bowl with cover and handles
Sucrier avec couvercle et anses Veneto
Azucarero con tapa y asas Veneto
Zuckerdose mit Deckel und Griffen Veneto

| | Gr. | Oz |
|---------------|-----|------|
| 305 05 04 572 | 250 | 8,75 |
| 305 05 04 573 | 360 | 12,6 |



Cremiera / lattiera / brocca acqua veneto

Veneto creamer / milk pot / water pitcher
Crémier / pot à lait / carafe à eau Veneto
Jarrita de leche / lechera / jarra agua Veneto
Gießbecher / Wasserkrug Venet

| | Lt | Oz |
|---------------|------|------|
| 305 05 03 598 | 0,15 | 5 |
| 305 05 03 599 | 0,35 | 12 |
| 305 05 03 600 | 0,60 | 21 |
| 305 05 03 601 | 0,90 | 31,5 |
| 305 05 03 602 | 1,50 | 53 |
| 305 05 03 604 | 2,00 | 70 |

| Brocca Acqua - Water Pitcher | | |
|------------------------------|------|----|
| 305 05 08 527 | 1,50 | 53 |
| 305 05 08 530 | 2,00 | 70 |



Cremiera / Lattiera Iseo

Iseo Creamer / milk pot
Crémier / pot à lait Iseo
Jarrita de leche / lechera Iseo
Milchkanne Iseo

| | Lt | Oz |
|---------------|------|------|
| 305 05 03 565 | 0,15 | 5 |
| 305 05 03 566 | 0,35 | 12 |
| 305 05 03 567 | 0,60 | 21 |
| 305 05 03 568 | 0,90 | 31,5 |
| 305 05 03 569 | 1,50 | 53 |
| 305 05 03 605 | 2,00 | 70 |



Caffettiera Iseo

Iseo coffee pot
Cafetière Iseo
Cafetera Iseo
Kaffeekanne Iseo

| | Lt | Oz |
|---------------|------|------|
| 305 05 01 545 | 0,35 | 12 |
| 305 05 01 546 | 0,60 | 21 |
| 305 05 01 547 | 0,90 | 31,5 |
| 305 05 01 548 | 1,50 | 53 |
| 305 05 01 598 | 2,00 | 70 |



Teiera Iseo

Iseo teapot
Theière Iseo
Tetera Iseo
Teekanne Iseo

| | Lt | Oz |
|---------------|------|------|
| 305 05 02 540 | 0,35 | 12 |
| 305 05 02 541 | 0,55 | 19 |
| 305 05 02 542 | 0,88 | 31,5 |



Brocca acqua Iseo

Iseo water pitcher
Carafe à eau Iseo
Jarra agua Iseo
Wasserkrug Iseo

| | Lt | Oz |
|---------------|------|----|
| 305 05 08 505 | 1,50 | 53 |
| 305 05 08 531 | 2,00 | 70 |



Zuccheriera Iseo

Iseo sugar bowl
Sucrier Iseo
Azucarero Iseo
Zuckerdose Iseo

| | Gr. | Oz |
|--------------------------------|-----|------|
| Senza manici - Without handles | | |
| 305 05 04 549 | 250 | 8,75 |
| Con manici - With handles | | |
| 305 05 04 550 | 360 | 12,6 |



Caraffa termica conica

Insulated beverage server
Pot isotherme
Jarra térmica
Thermische Karaffe

| | Lt | Oz |
|---------------|------|----|
| 305 05 08 557 | 0,30 | 10 |
| 305 05 08 558 | 0,60 | 21 |
| 305 05 08 559 | 1,00 | 35 |
| 305 05 08 560 | 1,50 | 53 |



Caraffa termica cilindrica

Insulated beverage server
Pot isotherme
Jarra térmica
Termische Karaffe

| | Lt | Oz |
|---------------|------|----|
| 305 05 08 540 | 0,60 | 21 |
| 305 05 08 541 | 1,00 | 35 |
| 305 05 08 542 | 1,50 | 53 |



Portasalatini

Snack holder
Service apéritif
Entremesera
Salzgebäckschale

| | | ø Cm | ø In. |
|---------------|-----------------------------|------|-------|
| 305 05 41 554 | 3 comparti - 3 bowls | 8,5 | 3,3/8 |
| 305 05 41 556 | 4 comparti - 4 bowls | 8,5 | 3,3/8 |
| 310 09 04 564 | Coppetta vetro - Glass bowl | 8,5 | 3,3/8 |



Alzatina piccola pasticceria

Petits fours stand
 Plat à petits fours sur pied
 Soporte pastas de té
 Petits-Fours-Ständer

| | ø Cm | H. Cm | ø In. | H. In. |
|---------------|------|-------|-------|--------|
| 305 05 41 512 | 16 | 17 | 6,1/4 | 6,3/4 |



Alzata piccola pasticceria 2/3 piani

Petits fours stand, 2/3 tier
 Plat à petits fours sur pied, 2/3 étages
 Soporte pastas de té 2/3 pisos
 Petits-Fours-Ständer, 2/3 stufig

| | | ø Cm | H. Cm | ø In. | H. In. |
|---------------|------------------|----------|-------|--------------------|--------|
| 305 05 41 516 | 2 piani - 2 tier | 16-22 | 24 | 6,1/4-8,5/8 | 9,1/2 |
| 305 05 41 517 | 3 piani - 3 tier | 16-22-26 | 39 | 6,1/4-8,5/8-10,1/4 | 15,3/8 |



Alzata pasticceria / portamarmellata 3 piani

Pastry stand / jam dish, 3 - tier
 Presentoir pâtissier / porte - confiture, 3 étages
 Soporte pastas de té / dispensador de mermelada, 3 pisos
 Kuchenständer / konfitüreschale, 3 stufig

| | ø Cm | H. Cm | ø In. | H. In. |
|---------------|--------------|-------|------------------|--------|
| 305 05 41 578 | 26 - 32 - 38 | 40 | 10,1/4-12,5/8-15 | 15,3/8 |

Alzata torta

Cake stand
Présentoir à gateaux
Soporte pastel
Tortenplatte

| | ø Cm | ø In. |
|---------------|------|--------|
| 305 05 42 516 | 22 | 8,5/8 |
| 305 05 42 517 | 32 | 12,5/8 |
| 305 05 42 518 | 42 | 16,1/2 |



Alzata frutta

Fruit stand
Plat à fruits sur pied
Frutero
Obstständer

| | ø Cm | ø In. |
|---------------|------|--------|
| 305 05 42 520 | 22 | 8,5/8 |
| 305 05 42 521 | 29 | 11,1/2 |
| 305 05 42 522 | 36,5 | 14,3/8 |



Portamarmellata con vaso fiori

Jam display with flower vase
Présentoir à confiture avec vase à fleurs
Soporte mermeladas con florero
Konfitüreschale - Display

| | H. Cm | H. In. |
|---------------|-------|--------|
| 305 05 09 511 | 21,5 | 8,1/2 |

5 comparti - 5 dishes



Portamarmellata

Jam display
Présentoir à confiture
Soporte mermeladas
Konfitüreschale - Display

| | H. Cm | H. In. |
|---------------|-------|--------|
| 305 05 09 530 | 14 | 5,1/2 |

3 comparti - 3 dishes



Alzata frutta 3 piani

Fruit stand, 3 - tier
Plat à fruits sur pied, 3 étages
Frutero, 3 pisos
Obststände, 3 stufig

| | ø Cm | H. Cm | ø In. | H. In. |
|---------------|----------------|-------|-------------------------|--------|
| 305 05 42 523 | 22 - 29 - 36,5 | 50 | 8,5/8 - 11,1/2 - 14,3/8 | 19,3/4 |



Alzata torta nuziale

Wedding cake stand
Presentoir à gâteaux de mariage
Soporte tarta nupcial
Hochzeitstortenplatte

| | ø Cm | H. Cm | ø In. | H. In. |
|---------------|--------------|-------|-------------------------|--------|
| 305 05 42 519 | 22 - 32 - 42 | 54 | 8,5/8 - 12,5/8 - 16,1/2 | 21,1/4 |





Oliera 2 posti

Oil & vinegar cruet, 2 - piece

Ménagère, 2 pièces

Juego aceitera vinagnero, 2 piezas

Essig-/Ölgestell, 2-tlg

| | Cm | H. Cm | In. | H. In. |
|---------------|------|-------|---------------|--------|
| 305 05 11 533 | 14x7 | 22 | 5,1/2 x 2,3/4 | 8,5/8 |



Set spargisale, spargipepe e portastecchi

Salt shaker, pepper shaker and toothpick holder set

Set salière, poivrier et porte cure-dents

Set salero, pimentero y palillero

Menage Komplet

| | Cm | H. Cm | In. | H. In. |
|---------------|----|-------|-----|--------|
| 305 05 12 557 | 10 | 13 | 4 | 5,1/8 |



Set spargisale e spargipepe

Salt shaker and pepper shaker set

Set salière et poivrier

Set salero y pimentero

Salz / Pfefferstreuer

| | Cm | H. Cm | In. | H. In. |
|---------------|--------|-------|-------|--------|
| 305 05 12 558 | 10 x 5 | 13 | 4 x 2 | 5,1/8 |



Spargisale - spargipepe

Salt and pepper shakers

Salière et poivrière

Salero y pimentero

Salz/Pfefferstreuer

| | Cm | In. |
|----------------------------|----|-------|
| Spargisale - Salt shaker | | |
| 305 05 12 502 | 8 | 3,1/8 |
| Spargipepe - Pepper shaker | | |
| 305 05 12 503 | 8 | 3,1/8 |



Tavoletta serigrafata in metacrilato

Small plate, methacrylate
Plaque en méthacrylate
Plaquita de metacrilato
Plexiglas Schild fuer Produktinfo

| | H. Cm | H. In. |
|---------------|-------|---------|
| 305 12 19 525 | 12x18 | 4,3/4x7 |

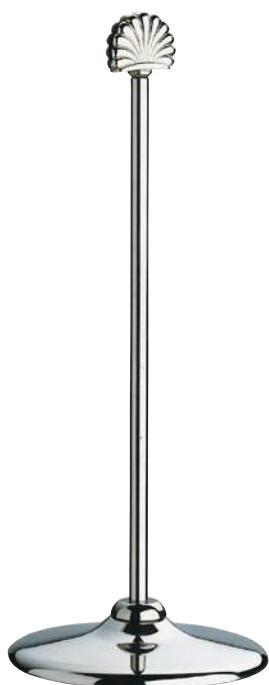

Portanumero da tavola

Table number stand
Support numéro de table
Soporte número de mesa
Tischnummerständer

| | H. Cm | H. In. |
|---------------|-------|--------|
| 305 05 19 524 | 30 | 11,3/4 |



Sottocoppa / vassoietto

Underliner / small round tray
Dessous de coupe / petit plateau rond
Posa vaso / bandejita redonda
Untersatz / Tablettchen

| | ø Cm | ø In. |
|---------------|------|-------|
| 305 05 21 513 | 12 | 4,3/4 |
| 305 05 21 514 | 14 | 5,1/2 |
| 305 05 23 561 | 16 | 6,1/4 |
| 305 05 23 562 | 20 | 7,7/8 |
| 305 05 23 563 | 22 | 8,5/8 |



Formaggiera con pomolo

Grated cheese bowl with knob
Fromagère avec pommeau
Quesera con pomo
Käsedose

| | ø Cm | ø In. |
|---------------|------|-------|
| 305 05 13 536 | 9 | 3,1/2 |



Formaggiera con coperchio a cerniera

Grated cheese bowl with hinged cover
Fromagère avec couvercle à charnière
Quesera con tapa con bisagra
Käsedose

| | ø Cm | ø In. |
|---------------|------|-------|
| 305 05 13 502 | 9 | 3,1/2 |



Burriera

Butter dish
Beurrier
Mantequera
Butterschale

| | ø Cm | ø In. |
|---------------|------|-------|
| 305 05 09 523 | 7 | 2,3/4 |



Coppa macedonia

Fruit salad cup
Coupe à dessert
Fuente para macedonia de frutas
Obstsalatschale

| | ø Cm | ø In. |
|---------------|------|-------|
| 305 05 43 536 | 12 | 4,3/4 |



Coppa multiuso / lavadita

Multipurpose bowl / fingerbowl
Coupe multi-usage / rince-doigts
Bol multiuso / lavaditos
Universalschale / Fingerschale

| | ø Cm | ø In. |
|---------------|------|-------|
| 305 05 43 537 | 12 | 4,3/4 |



Piattino

Underliner
Dessous de coupe
Platito posacopa
Untersatz

| | ø Cm | ø In. |
|---------------|------|-------|
| 305 05 21 513 | 12 | 4,3/4 |



Coppa supreme

Supreme cup - Coupe à suprême
Copa supreme - Schale Supreme

| | ø Cm | ø In. |
|---------------|------|-------|
| 305 05 43 546 | 13 | 5,1/8 |



Coppetta interna acciaio inossidabile

Stainless steel inside cup - Coupe intérieure en acier inoxydable
Copita interior en acero inoxidable - Schale, Edelstahl rostfrei

| | ø Cm | ø In. |
|---------------|------|-------|
| 305 05 43 541 | 9 | 3,1/2 |



Anello adattatore

Adjusting ring - Bague de réglage
Anillo adaptador - Einsatzring

| | ø Cm | ø In. |
|---------------|------|-------|
| 305 05 43 540 | 10,5 | 4,1/8 |



Coppa esterna base

Outside base cup - Coupe base extérieure
Copa exterior base - Schale auf Fuß

| | ø Cm | ø In. |
|---------------|------|-------|
| 305 05 43 539 | 13 | 5,1/8 |



Coppetta interna cristallo

Crystal inside cup - Coupe intérieure en cristal
Bol pequeño interior en cristal - Schale, kristall

| | ø Cm | ø In. |
|---------------|------|-------|
| 305 08 43 545 | 10 | 4 |



Piattino portaburro

Butter dish - Coupe à beurre
Mantequera - Butterschale

| | ø Cm | ø In. |
|---------------|------|-------|
| 305 05 22 648 | 9 | 3,1/2 |



Griglia portaburro

Butter grid - Plat à beurre perforé
Parrilla para mantequera - Buttergitter

| | ø Cm | ø In. |
|---------------|------|-------|
| 305 05 72 539 | 9 | 3,1/2 |



Piatto presentazione decoro inglese

Show plate, English decoration

Plat de présentation, decor anglais

Plato de presentación, decoración inglesa

Platzteller, Dekor English

| | ø Cm | ø In. |
|---------------|------|--------|
| 305 05 25 533 | 31,5 | 12,3/8 |
| 305 05 25 562 | 33 | 13 |



Piatto presentazione a falda larga

Show plate, wide rim
Plat de présentation à aile large
Plato de presentación con ala amplia
Platzteller

| | ø Cm | ø In. |
|---------------|------|--------|
| 305 05 25 513 | 32 | 12,5/8 |



Piatto presentazione leggero bordo rivoltato

Light show plate, turned edge
Plat de présentation léger, bord retourné
Plato de presentación ligero, borde revuelto
Platzteller

| | ø Cm | ø In. |
|---------------|------|--------|
| 305 05 25 524 | 31 | 12,5/8 |



Lampada da tavolo

Candle lamp
Lampe à bougie
Lampara de vela
Windlicht mit Kristall

| | H. Cm | H. In. |
|---------------|-------|--------|
| 305 05 17 512 | 21 | 8,1/4 |

Ricambio cristallo - Spare crystal part
 310 09 17 505



Coppa caviale

Caviar cup
Coupe à caviar
Copa caviar
Caviarkühler

| | ø Cm | ø In. |
|---------------|-------|---------------|
| 305 09 43 563 | 20/11 | 7,7/8 / 4,3/8 |



Coppa gelato

Ice cream cup
Coupe à glace
Copa helado
Eisschale

| | ø Cm | ø In. | H. Cm | H. In. |
|---------------|------|-------|-------|--------|
| 305 05 43 627 | 10,5 | 4,1/8 | 9,5 | 3,3/4 |

Supporto frutti di mare con piatto

Oyster tray stand with tray
 Support fruits de mer avec plateau
 Soporte para mariscos con fuente
 Meerfrüchteplatte

| | | ø Cm | ø In. |
|---------------|---------------------|-------|---------------|
| 305 05 20 540 | Supporto - Stand | 27-34 | 10,5/8-13,3/8 |
| 305 05 20 638 | Completo - Complete | 32 | 12,5/8 |
| 305 05 20 639 | Completo - Complete | 38 | 15 |



Piatto lumache a 6/12 fori

Snail dish, 6/12 - hole
 Plat à escargots, 6/12 places
 Plato caracoles, 6/12 unidades
 Schneckenplatte, 6/12 Löcher

| | | ø Cm | ø In. |
|---------------|------|------|--------|
| 305 05 22 633 | (6) | 26 | 10,1/4 |
| 305 05 22 634 | (12) | 32 | 12,5/8 |

Salsiera Veneto

Veneto sauce boat
 Saucière Veneto
 Salsiera Veneto
 Sauciere Veneto

| | ø Cl |
|---------------|------|
| 305 05 12 598 | 15 |
| 305 05 12 599 | 23 |
| 305 05 12 600 | 44 |



Salsiera Iseo

Iseo sauce boat
 Saucière Iseo
 Salsiera Iseo
 Sauciere Iseo

| | ø Cl |
|---------------|------|
| 305 05 12 547 | 15 |
| 305 05 12 548 | 23 |
| 305 05 12 549 | 44 |



Cestini pane / frutta

Bread / fruit basket
 Corbeille à pain / fruits
 Cesta pan / fruta
 Brot / Obstkorb

| | ø Cm | ø In. |
|---------------|------|-------|
| 305 05 24 505 | 19 | 7,1/2 |
| 305 05 24 506 | 23 | 9 |



Cestino pane ovale

Oval bread basket
 Corbeille à pain ovale
 Cesta pan/fruta oval
 Brotkorb oval

| | Cm | In. |
|---------------|---------|----------------|
| 305 05 24 507 | 27 x 19 | 10,5/8 x 7,1/2 |



Cestini pane / frutta

Bread / fruit basket
 Corbeille à pain / fruits
 Cesta pan / fruta
 Brot / Obstkorb

| | ø Cm | ø In. |
|---------------|------|-------|
| 305 05 24 503 | 19 | 7,1/2 |
| 305 05 24 504 | 23 | 9 |



Cestino pane ovale

Oval bread basket
 Corbeille à pain ovale
 Cesta pan/fruta oval
 Brotkorb oval

| | Cm | In. |
|---------------|---------|------------|
| V01 05 24 028 | 28 x 15 | 11,1/8 x 6 |

Cloche

Dome cover
 Cloche
 Campana
 Cloche

| | ø Cm Int. | ø Cm Est. | ø In. Int. | ø In. est. |
|---------------|-----------|-----------|------------|------------|
| 305 05 53 554 | 18 | 20,5 | 7 | 8 |
| 305 05 53 555 | 22 | 24 | 8,5/8 | 9,1/2 |
| 305 05 53 556 | 24 | 26 | 9,1/2 | 10,1/4 |
| 305 05 53 562 | 28 | 30 | 11 | 11,3/4 |
| 305 05 53 569 | 30 | 32 | 11,3/4 | 12,5/8 |



Coperchio

Cover
 Cover
 Cover
 Cover

| | ø Cm Int | ø In. Int. |
|---------------|----------|------------|
| 305 05 15 714 | 14 | 5,1/2 |
| 305 05 15 715 | 18 | 7 |
| 305 05 15 716 | 24 | 9,1/2 |
| 305 05 15 717 | 28 | 11 |



Zuppiera

Soup tureen
 Soupière
 Sopera
 Suppenschüssel

| | ø Cm Int | ø In. Int. |
|---------------|----------|------------|
| 305 05 15 706 | 14 | 5,1/2 |
| 305 05 15 707 | 18 | 7 |
| 305 05 15 708 | 24 | 9,1/2 |
| 305 05 15 709 | 28 | 11 |



Legumiera

Vegetable dish
 Légumier
 Legumbrera
 Gemüseschüssel

| | ø Cm Int | ø In. Int. |
|---------------|----------|------------|
| 305 05 15 710 | 14 | 5,1/2 |
| 305 05 15 711 | 18 | 7 |
| 305 05 15 712 | 24 | 9,1/2 |
| 305 05 15 713 | 28 | 11 |



Secchio champagne Wine & Bar 2/3 bottiglie

Wine & Bar champagne bucket, 2/3 - bottle
 Seau à Champagne, 2/3 bouteilles Wine & Bar
 Champañera, 2/3 botellas Wine & Bar
 Wine & Bar Champagnerkühler, 2/3 Flaschen

| | ø Cm | H. Cm | ø In. | H. In. |
|---------------|------|-------|-------|--------|
| V78 05 20 022 | 22 | 21 | 8,5/8 | 8,1/4 |



Supporto secchio champagne Wine & Bar

Wine & Bar champagne bucket stand
 Support pour seau à champagne Wine & Bar
 Soporte para champañera Wine & Bar
 Wine & Bar Weinkühlerständer

| | H. Cm | H. In. |
|---------------|-------|--------|
| V78 05 20 675 | 67,5 | 26,5/8 |



Secchiello ghiaccio e glacette doppio corpo Wine & Bar

Wine & Bar ice bucket and double-wall bottle cooler
 Seau à glace et rafraîchisseur à bouteille double paroi Wine & Bar
 Cubo hielo y enfriador de botella doble pared Wine & Bar
 Wine & Bar Eiswürfelbehälter und Weinkühler

| | ø Cm | H. Cm | ø In. | H. In. |
|---------------|------|-------|-------|--------|
| V78 05 20 014 | 13 | 18 | 5,1/8 | 7 |
| V78 05 24 014 | 13 | 21 | 5,1/8 | 8,1/4 |



Supporto glacette Wine & Bar

Wine & Bar bottle cooler stand
 Support pour rafraîchisseur à bouteille Wine & Bar
 Soporte para enfriador de botella Wine & Bar
 Wine & Bar Weinkühler-Ständer

| | H. Cm | H. In. |
|---------------|-------|--------|
| V01 05 20 676 | 67,5 | 26,5/8 |



Secchiello ghiaccio e secchio champagne

Ice bucket and champagne bucket
Seau à glace et seau à Champagne
Cubo hielo y champañera
Eis / Sektkühler

| | ø Cm | H. Cm | ø In. | H. In. |
|---------------|------|-------|-------|--------|
| 305 05 20 533 | 18 | 17 | 7,1/8 | 6,3/4 |
| 305 05 20 534 | 24 | 22 | 9,1/2 | 8,5/8 |



Secchiello ghiaccio e secchio champagne

Ice bucket and champagne bucket
Seau à glace et seau à Champagne
Cubo hielo y champañera
Eis / Sektkühler

| | ø Cm | H. Cm | ø In. | H. In. |
|---------------|------|-------|-------|--------|
| 305 05 20 541 | 13 | 13 | 5,1/8 | 5,1/8 |
| 305 05 20 542 | 21 | 20 | 8,1/4 | 7,7/8 |



Supporto secchio champagne Iseo

Iseo champagne bucket stand
Support pour seau à champagne Iseo
Soporte para champañera Iseo
Iseo Weinkühlerständer

| | H. Cm | H. In. |
|---------------|-------|--------|
| 305 05 20 535 | 61 | 24 |



Secchio champagne ovale Modern

Modern champagne cooler, oval
Seau à champagne ovale Modern
Champañera oval Modern
Modern oval Champagnekühler

| | ø Cm | H. Cm | ø In | H. In |
|---------------|------|-------|--------|-------|
| 305 05 20 681 | 27 | 21,5 | 10,5/8 | 8,5/1 |



Supporto secchio ovale Modern

Champagne bucket stand, oval
Support pour seau à champagne
Soporte champañera
Sektkühlerständer

| | H. Cm | H. In |
|---------------|-------|--------|
| 305 05 20 668 | 59,5 | 23,1/2 |



Supporto secchio ovale da tavolo

Table-wine bucket stand, oval
Support de table pour seau
Soporte champañera de mesa
Sektkühlerständer

| | Cm | H. Cm | In | H. In |
|---------------|-------|-------|-------------|-------|
| 335 05 20 686 | 17x22 | 11 | 6,3/4x8,5/8 | 4,3/8 |



Secchio champagne tondo Modern

Modern champagne cooler, round
Seau à champagne Modern rond
Champañera Modern redonda
Modern Champagnekühler rund

| | Ø Cm | H. Cm | Ø In. | H. In. |
|---------------|------|-------|-------|--------|
| V78 05 20 002 | 24 | 22 | 9,1/2 | 8,5/8 |



Supporto secchio tondo Modern

Modern champagne cooler stand, round
Support rond pour seau à champagne Modern
Soporte redondo para champañera Modern
Modern Champagnekühler Ständer rund

| | Cm | In |
|---------------|----|--------|
| V78 05 20 676 | 57 | 22,1/2 |



Reggisechio da tavolo

Champagne bucket table stand
Support de table pour seau à champagne
Soporte de mesa para cubo champán
Tischweinkühler

| | Ø Cm | Ø In. |
|---------------|------|-------|
| 305 05 20 561 | 20 | 7,7/8 |



Secchiello ghiaccio e glacette doppio corpo Modern

Modern ice bucket and double-wall bottle cooler

Seau à glace et rafraîchisseur à bouteille double paroi Modern

Cubo hielo y enfriador de botella doble pared Modern

Modern Eiswürfelbehälter und Weinkühler

| | ø Cm | H. Cm | ø In. | H. In. |
|--------------------|------|-------|-------|--------|
| V78 05 20 001 1401 | 15,3 | 17 | 6 | 15,3 |
| V78 05 24 010 1401 | 12 | 19,5 | 4,7 | 7,6 |



Coppa champagne

Champagne bottle bowl

Bol à champagne

Champañera

Champagne Schale

| | Lt | ø Cm | ø In. |
|-----------------|----|------|--------|
| V77 05 52 PUN 3 | 25 | 53 | 20,7/8 |



Coppa punch doppio corpo

Punch bowl, double-wall

Bol à punch double paroi

Champañera doble pared

Champagne Schale

| | Lt | ø Cm | ø In. |
|-----------------|----|------|--------|
| V77 05 52 PUN 2 | 10 | 39 | 15,3/8 |



Coppa punch

Punch bowl
Bol à punch
Champañera
Punchschale

| | Lt | ø Cm | ø In. |
|---------------|----|------|--------|
| 305 05 43 543 | 13 | 40 | 15,3/4 |
| 305 05 43 575 | 30 | 50 | 19,3/4 |



Anello portabottiglie per coppa punch ø 40 Cm

Bottle adapter ring for ø 40 Cm punch bowl
Anneau porte-bouteilles pour bol a punch ø 40 Cm
Anillo para botellas champacera ø 40 Cm
Ring Flaschenhalter fuer Punchschale ø 40 Cm

| | ø Cm | ø In. |
|---------------|------|--------|
| 305 05 43 544 | 30 | 11,3/4 |

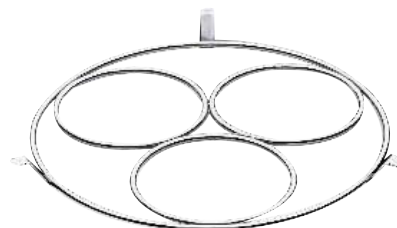

Inserto in metacrilato per coppa punch ø 40

Acrylic bowl for punch bowl ø 40
Bol acrylique pour bol à punch ø 40
Copa acrilica para champañera ø 40
Innere Acrylschale ø 40

| | | ø Cm | ø In. |
|---|---|------|--------|
| ❶ | Coperchio - Cover 305 12 43 566 | 35 | 13,3/4 |
| ❷ | Inserto - Bowl 305 12 43 564 | 33 | 13 |
| ❸ | Anello adattatore - Adjusting ring 305 05 43 565 | 33 | 13 |
| ❹ | Mestolo punch - Punch ladle CSV 66 | | |





Portatovaglioli da banco verticale

Vertical napkin holder
Porte-serviettes vertical
Servilletero cuadrado vertical
Vertikaler Thekenserviettenhalter

| | ø Cm | H. Cm | In. | H. In. |
|------------|----------|-------|---------------|--------|
| 906 05 008 | 8,5 x 11 | 16 | 3,3/8 x 4,3/8 | 6,1/4 |



Portatovaglioli

Napkin holder
Porte-serviettes
Servilletero
Serviettenhalter

| | L. Cm | H. Cm | L. In. | H. In. |
|---------------|-------|-------|--------|--------|
| 305 05 71 938 | 11 | 9 | 4,3/8 | 3,1/2 |



Portatovaglioli antivento

Windproof napkin holder
Porte-serviettes coupe-vent
Servilletero anti viento
Serviettenhalter Windschutz

| | Cm | In. | H. Cm | H. In. |
|---------------|-----------|-------------|-------|--------|
| 305 05 71 983 | 10x10 | 3,7/8x3,7/8 | 3 | 1,1/8 |
| 305 05 71 988 | 12,5x12,5 | 4,7/8x4,7/8 | 4 | 1,5/8 |
| 305 05 71 989 | 16x16 | 6,1/4x6,1/4 | 4 | 1,5/8 |



Portatovaglioli quadrato

Square napkin holder
Porte serviettes carré
Servilletero cuadrado
Viereckiger Serviettenhalter

| | Cm | H. Cm | In. | H. In. |
|---------------|---------|-------|---------------|--------|
| V01 05 71 190 | 19 x 19 | 7 | 7,1/2 x 7,1/2 | 2,3/4 |

Portabustine di zucchero / the

Sugar / tea bag holder
Porte-sachets de sucre / thé
Porta sobres de azúcar / té
Zucker - Teeehälter

| | Cm | H. Cm | In. | H. In. |
|---------------|--------|-------|-------|--------|
| V78 05 04 PBU | 5 x 10 | 6,5 | 2 x 4 | 2,1/2 |



Contentitore per noccioli olive

Olive stone holder
Conteneur pour noyaux d'olives
Contenedor para nubes de aceitunas
Oliven Keimbehälter

| | Cm | H. Cm | In. | H. In. |
|---------------|-------|-------|-------|--------|
| 305 05 04 591 | 5 x 5 | 6,5 | 2 x 2 | 2,1/2 |



Vassoio con portabustine

Tray with sugar-bag holders
Plateau avec sucriers
Bandeja con azucareros
Tablett mit Zuckerbehälter

| | Cm | In. |
|---------------|---------|----------------|
| 305 05 23 877 | 26 x 14 | 10,1/4 x 5,1/2 |



Vassoio rendiresto

Small change tray
Plateau porte-monnaie
Bandeja portamoneda
Geldplatte

| | Cm | In. |
|---------------|---------|----------------|
| 305 05 23 876 | 26 x 12 | 10,1/4 x 5,1/2 |





Padella flambé, rame / stagno

Flambé pan, copper / tin
 Poêle à flamber, cuivre / étan
 Sartén para flambear, cobre / estaño
 Flambierpfanne, Kupfer / Zinn

| | ø Cm | ø In. |
|---------------|------|--------|
| 305 05 72 543 | 30 | 11,3/4 |



Fornello flambé a gas acciaio

Flambé burner, gas, stainless steel
 Réchaud à flamber, gaz
 Calentador para flambear, gas
 Flambierrechaud / Gaskocher

| | H. Cm | H. In. |
|---------------|-------|--------|
| 305 05 52 625 | 26 | 10,1/4 |



Fornello flambé gas ramato

Flambé burner, alcohol, copper plated
 Réchaud à flamber, alcool, cuivré
 Calentador para flambear, alcohol
 Flambierrechaud / Spirituskocher

| | H. Cm | H. In. |
|---------------|-------|--------|
| 305 10 52 625 | 26 | 10,1/4 |



Vassoio rettangolare con maniglie

Rectangular tray with handles
Plateau rectangulaire avec anses
Bandeja rectangular con asas
Austellplatte, rechteckig mit Griffen

| | Cm | In. |
|---------------|---------|-----------------|
| 305 05 23 572 | 27x 21 | 10,5/8 x 8,1/4 |
| 305 05 23 575 | 35 x 28 | 13,3/4 x 11 |
| 305 05 23 573 | 40 x 32 | 15,3/4 x 12,5/8 |
| 305 05 23 574 | 50 x 38 | 19,3/4 x 15 |



Vassoio rettangolare

Rectangular tray
Plateau rectangulaire
Bandeja rectangular
Austellplatte, rechteckig

| | Cm | In. |
|---------------|---------|-----------------|
| 305 05 23 568 | 27 x 21 | 10,5/8 x 8,1/4 |
| 305 05 23 571 | 35 x 28 | 13,3/4 x 11 |
| 305 05 23 569 | 40 x 32 | 15,3/4 x 12,5/8 |
| 305 05 23 570 | 50 x 38 | 19,3/4 x 15 |



Vassoio tondo bar con maniglie

Round bar tray with handles
Plateau rond bar avec anses
Bandeja redonda bar con asas
Austellplatte mit Griffen

| | ø Cm | ø In. |
|---------------|------|--------|
| 305 05 23 566 | 32 | 12,5/8 |
| 305 05 23 567 | 38 | 15 |
| 305 05 23 775 | 46 | 18,1/8 |
| 305 05 23 776 | 54 | 21,1/4 |

Vassoio tondo bar

Round bar tray
 Plateau rond bar
 Bandeja redonda bar
 Austellplatte

| | ø Cm | ø In. |
|---------------|------|--------|
| 305 05 23 564 | 32 | 12,5/8 |
| 305 05 23 565 | 38 | 15 |
| 305 05 23 774 | 46 | 18,1/8 |
| 305 05 23 734 | 54 | 21,1/4 |



Tappetino antiscivolo

Non-slip mat
 Tapis antidérapant
 Rutschfeste Matte
 Alfombrilla antideslizante



| | ø Cm | ø In. |
|---------------|------|--------|
| 305 12 27 501 | 21 | 8,1/4 |
| 305 12 27 502 | 32 | 12,5/8 |



Vassoio rettangolare gastronom

Gastronorm rectangular tray
 Plateau rectangulaire gastronomie
 Bandeja rectangular gastronorm
 Gastronorm Tablett, rechteckig

| | Cm | In. |
|---------------|-------------------|-----------------|
| V01 05 23 G12 | 26,5 x 32,5 (1/2) | 10,3/8 x 12,3/4 |
| V01 05 23 G11 | 53 x 32,5 (1/1) | 20,7/8 x 12,3/4 |
| V01 05 23 G21 | 65 x 53 (2/1) | 25,5/8 x 20,7/8 |



Vassoio rettangolare gastronom con maniglie

Gastronorm rectangular tray with handles
 Plateau rectangulaire gastronomie avec poignées
 Bandeja rectangular gastronorm con asas
 Gastronorm Tablett, mit Griffen - rechteckig

| | Cm | In. |
|-----------------|-----------------|-----------------|
| V01 05 23 G11 M | 53 x 32,5 (1/1) | 20,7/8 x 12,3/4 |
| V01 05 23 G21 M | 65 x 53 (2/1) | 25,5/8 x 20,7/8 |





Vassoio bar rettangolare

Rectangular bar tray - Plateau bar rectangulaire

Bandeja bar rectangular - Austellplatte, rechteckig

| | Cm | In. |
|---------------|---------|-----------------|
| 305 05 23 690 | 30 x 24 | 11,3/4 x 9,1/2 |
| 305 05 23 691 | 35 x 29 | 13,2/4 x 11,1/2 |
| 305 05 23 692 | 40 x 31 | 15,3/4 x 12,1/4 |
| 305 05 23 693 | 45 x 35 | 17,3/4 x 13,2/4 |
| 305 05 23 694 | 52 x 40 | 20,1/2 x 15,3/4 |
| 305 05 23 695 | 62 x 48 | 24,3/8 x 19 |

Con maniglie - With handles

| | Cm | In. |
|---------------|---------|-----------------|
| 305 05 23 696 | 52 x 40 | 20,1/2 x 15,3/4 |
| 305 05 23 697 | 62 x 48 | 24,3/8 x 19 |

Piatto ovale da portata

Oval dish
 Plate oval
 Fuente oval
 Bratenplatte, oval

| | Cm | In. |
|---------------|---------|-----------------|
| 305 05 22 643 | 30 x 20 | 11,3/4 x 7,7/8 |
| 305 05 22 644 | 35 x 24 | 13,3/4 x 9,1/2 |
| 305 05 22 645 | 40 x 27 | 15,3/4 x 10,5/8 |
| 305 05 22 646 | 45 x 30 | 17,3/4 x 11,3/4 |
| 305 05 22 647 | 50 x 34 | 19,3/4 x 13,3/8 |



Piatto ovale da portata con copripiatto

Oval dish with cover
 Plat oval avec cloche
 Fuente oval con cubreplato
 Bratenplatte, oval, mit Deckel

| | Cm | In. |
|-----------------------------------|---------|-----------------|
| 305 05 22 643 | 30 x 20 | 11,3/4 x 7,7/8 |
| 305 05 53 551 (Coperchio - Cover) | 30 x 20 | 11,3/4 x 7,7/8 |
| 305 05 22 645 | 40 x 27 | 15,3/4 x 10,5/8 |
| 305 05 53 552 (Coperchio - Cover) | 40 x 27 | 15,3/4 x 10,5/8 |
| 305 05 22 647 | 50 x 34 | 19,3/4 x 13,3/8 |
| 305 05 53 553 (Coperchio - Cover) | 50 x 34 | 19,3/4 x 13,3/8 |



Piatto tondo da portata con copripiatto

Round plate with cover
 Plat rond avec cloche
 Fuente redonda con cubreplato
 Servierplatte, rund mit Deckel

| | ø Cm | ø In. |
|-----------------------------------|------|--------|
| 305 05 22 637 | 26 | 10,1/4 |
| 305 05 53 548 (Coperchio - Cover) | 26 | 10,1/4 |
| 305 05 22 638 | 32 | 12,5/8 |
| 305 05 53 549 (Coperchio - Cover) | 32 | 12,5/8 |
| 305 05 22 639 | 38 | 15 |
| 305 05 53 550 (Coperchio - Cover) | 38 | 15 |



Piatto salmone (argentato/legno)

Salmon cutting board (electro-plated stainless steel and wood)
Planche à saumon (acier argenté et bois)
Fuente salmón (acero plateado y madera)
Lachsplatte, versilbert mit Holz



| | Cm | In. |
|---------------|---------|----------------|
| 305 07 22 656 | 87 x 19 | 34,1/4 x 7,1/2 |

Piatto pesce

Fish dish
Plat à poisson
Fuente pescado
Fischplatte

| | Cm | In. |
|---------------|-----------|-----------------|
| 305 05 22 662 | 60 x 27,2 | 23,5/8 x 10,5/8 |
| 305 05 22 663 | 70 x 28,5 | 27,1/2 x 11,1/4 |
| 305 05 22 664 | 85 x 33 | 33,1/2 x 13 |



Vassoio tondo per banchetti

banquet tray
Plateau rond pour banquets
Bandeja redonda para banquetes
Bankettservierbrett, rund

| | ø Cm | ø In. |
|---------------|------|--------|
| 305 05 22 651 | 80 | 31,1/2 |



Vassoio tondo

Round tray
Plateau rond
Bandeja redonda
Tablett, rund

| | ø Cm | ø In. |
|---------------|------|--------|
| 305 05 23 507 | 35 | 13,3/4 |
| 305 05 23 508 | 40 | 15,3/4 |
| 305 05 23 509 | 45 | 17,3/4 |



Piatto ovale da portata

Oval dish
Plat oval
Fuente oval
Servierplatte, oval

| | Cm | In. |
|---------------|---------|-----------------|
| 305 05 22 513 | 25 x 17 | 9,7/8 x 6,3/4 |
| 305 05 22 517 | 36 x 25 | 14,1/8 x 9,7/8 |
| 305 05 22 519 | 38 x 26 | 15 x 10,1/4 |
| 305 05 22 520 | 47 x 34 | 18,1/2 x 13,3/8 |
| 305 05 22 522 | 53 x 35 | 20,7/8 x 13,3/4 |
| 305 05 22 515 | 29 x 20 | 11,1/2 x 7,7/8 |
| 305 05 22 524 | 59 x 40 | 23,1/4 x 15,3/4 |



Copripiatto sovrapponibile

Plate cover, stackable
Cloche ronde empilable
Cubreplato apilable
Cloche, stappelbar

| | ø Cm | ø In. |
|---------------|------|--------|
| 305 05 53 619 | 24.5 | 9,5/8 |
| 305 05 53 620 | 27 | 10,5/8 |
| 305 05 53 621 | 28 | 11 |
| 305 05 53 604 | 29 | 11,1/2 |
| 305 05 53 622 | 30 | 11,3/4 |
| 305 05 53 618 | 31 | 12,1/4 |



Piatto tondo da portata

Round plate
Plat rond
Fuente redonda
Servierplatte, rund

| | ø Cm | ø In. |
|---------------|------|--------|
| 305 05 22 505 | 29 | 11,1/2 |
| 305 05 22 507 | 38 | 15 |



Portacannucce e portacucchiaini Imperial

Imperial straw holder and tea spoon holder
Porte-pailles et porte-cuillers à café Imperial
Portapajitas y portacucharitas café Imperial
Trinkhalme/Löffelbehälter Imperial

Portacucchiaini - Tea spoon holder

| | ø Cm | H. Cm | ø In. | H. In. |
|---------------|------|-------|-------|--------|
| V01 05 71 008 | 9 | 8 | 3,1/2 | 3,1/8 |

Portacannucce - Straw holder

| | ø Cm | H. Cm | ø In. | H. In. |
|---------------|------|-------|-------|--------|
| V01 05 71 011 | 9 | 11 | 3,1/2 | 4,3/8 |



Spargicacao

Cocoa shaker
Saupoudreuse de cacao
Espolvoreador de cacao
Kakaostreuer

| | ø Cm | ø In. | Cl | Oz |
|---------------|------|-------|----|----|
| 909 05 XX 028 | 5,3 | 2,1/8 | 18 | 6 |



Cestello agrumi

Fruit basket
Corbeille à agrumes
Cesta cítricos
Obstkorb

| | ø Cm | H. Cm | ø In. | H. In. |
|------------|------|-------|-------|--------|
| 906 05 001 | 21 | 20 | 8,1/4 | 7,7/8 |



Additional Items

Shaker

Cocktail shaker
Shaker
Coctelera
Cocktail Shaker

| | Lt | Oz |
|---------------|------|----|
| V78 05 81 SHA | 0,50 | 18 |

Acciaio inossidabile 18/10 - Stainless steel 18/10



Bicchieri Boston

Boston mixing container
Verre en métal pour Boston
Vaso en metal para Boston
Boston Metallbecher

| | H. Cm | H. In. |
|------------------|-------|--------|
| V78 05 81 SHA 2B | 17 | 6,3/4 |



Vetro per bicchiere Boston

Boston glass
Verre pour Boston
Vaso en vidrio para Boston
Boston Rührglas

| | Lt |
|------------------|-----|
| V78 08 81 SHA 2B | 0,7 |

Misurino Basic

Basic jigger
Mésure Basic
Meßbecher Basic
Medida bar Basic

| | MI | Oz |
|----------------|-------|-------|
| V78 05 81 DOS1 | 15-30 | 1/2-1 |



Filtro cocktail Basic

Basic cocktail strainer
Passoire à cocktail Basic
Barsieb Basic
Colador de cóctel Basic

| | Cm | In |
|----------------|----|-------|
| V78 05 81 FCO1 | 14 | 5,1/2 |



Cod. ...05 Acciaio - 18/10 St.Steel
Cod. ...07 Acciaio Argentato - EPSS

Coppa gelato

Ice cream cup
Coupe à glace
Copa helado
Speiseeisschale

| | ø Cm | H. Cm | ø In. | H. In. |
|---------------|------|-------|-------|--------|
| V01 05 43 010 | 9 | 9 | 3,1/2 | 3,1/2 |



Vasetto portafiori

Flower vase
Vase à fleurs
Florero
Blumenvase

| | H. Cm | H. In. |
|---------------|-------|--------|
| V01 05 19 015 | 16 | 6,1/4 |



Portauovo

Egg cup
Coquetier
Huevera
Eierbecher

| | ø Cm | ø In. |
|---------------|------|-------|
| V01 05 71 001 | 6 | 2,3/8 |



Passatè con coppetta

Tea strainer with drip bowl
Passoire à thé avec petite coupe
Colador de té con copita
Teesieb mit Schälchen

| | Cm | In. |
|---------------|----|-------|
| V01 05 91 001 | 7 | 2,3/4 |



Additional Items

Portamenù Acciaio Inox

Menu support St.Steel
Porte-menu Acier Inox
Porta menú Acero Inox
Menükartenhalter, Edelstahl

| | Cm | In. | H. Cm | H. In |
|---------------|-----|-------|-------|-------|
| 305 05 18 539 | 8x5 | 3,1/8 | 2 | 0,3/4 |



Numero tavola / segnaposto

Table number / place card
Numéro de table / marque-place
Número de mesa / etiqueta
Tischnummer

| | Cm | In. |
|---------------|---------|-------------|
| 305 05 19 530 | 6,5 x 4 | 2,1/2x1,5/8 |



Numero tavola / segnaposto

Table number / place card
Numéro de table / marque-place
Número de mesa / etiqueta
Tischnummer

| | Cm | In. |
|---------------|------------|---------------|
| 305 05 19 517 | 11,5 x 6,5 | 4,1/2 x 2,1/2 |



Segnaposto a colonna (portanumero)

Place card, column shaped
Support numéro de table
Soporte número de mesa
Tischnummerständer

| | H. Cm | H. In. |
|---------------|-------|--------|
| V01 05 19 019 | 19 | 7,1/2 |
| V01 05 19 046 | 46 | 18,1/8 |



Cod. ...05 Acciaio - 18/10 St.Steel
Cod. ...07 Acciaio Argentato - EPSS

Levatappi cameriere

Waiter's corkscrew
Tire-bouchons sommelier
Sacacorchos de camarero
Kellner-Korkenzieher

305 05 71 687



Supporto versavino a filo

Red wine holder stand
Support pour porte-bouteille
Soporte para portabotella
Rotweingestell

| | Cm | H. Cm | In. | H. In. |
|---------------|----|-------|-------|--------|
| V01 05 24 022 | 22 | 20,5 | 8,5/8 | 8 |



Sottobottiglia / sottobicchiere

Bottle coaster / glass coaster
Dessous de bouteille / dessous de verre
Posa botella / posavasos
Flaschenuntersatz / Untersatz

| | ø Cm (Int.) | ø Cm (Est.) | ø In. (Int.) | ø In. (Est.) |
|---------------|-------------|-------------|--------------|--------------|
| 305 05 21 506 | 9 | 13,5 | 3,1/2 | 5,3/8 |
| 305 05 21 505 | 8 | 12,5 | 3,1/2 | 5,3/8 |



Posacenere

Ashtray
Cendrier
Cenicero
Ascher

| | Cm | In. |
|---------------|-------------|---------------|
| 305 05 71 504 | 11,5 x 11,5 | 4,1/2 x 4,1/2 |



Additional Items



Macinapepe in legno naturale

Wood pepper mill, light colour
Moulin à poivre en bois naturel
Molinillo pimienta en madera natural
Holzpfeffermühle, hell-braun

| | H. Cm | H. In. |
|---------------|-------|--------|
| 489 00 61 50N | 13 | 5,1/8 |
| 489 00 61 51N | 19 | 7,1/2 |
| 489 00 61 52N | 25 | 9,78 |
| 489 00 61 53N | 33 | 13 |
| 489 00 61 54N | 42 | 16,1/2 |
| 489 00 61 55N | 53 | 20,7/8 |



Macinapepe in legno noce

Wood pepper mill, dark colour
Moulin à poivre en bois foncé
Molinillo pimienta en madera oscura
Holzpfeffermühle, dunkel-braun

| | H. Cm | H. In. |
|---------------|-------|--------|
| 489 00 61 50T | 13 | 5,1/8 |
| 489 00 61 51T | 19 | 7,1/2 |
| 489 00 61 52T | 25 | 9,78 |
| 489 00 61 53T | 33 | 13 |
| 489 00 61 54T | 42 | 16,1/2 |
| 489 00 61 55T | 53 | 20,7/8 |



Macinapepe laccato

Lacquered pepper mill
Moulin à poivre lacqué
Molinillo pimienta lacado
Pfeffermühle, Lackiert

| | H. Cm | H. In. |
|---------------|-------|--------|
| 489 06 25 0LM | 22 | 8,5/8 |
| 489 06 25 1LM | 32 | 12,5/8 |
| 489 06 25 2LM | 42 | 16,1/2 |

Macinapepe in metacrilato

Acrylic pepper mill
Moulin à poivre acrylique
Molinillo pimienta acrílico
Pfeffermühle, Acryl

| | H. Cm | H. In. |
|---------------|-------|--------|
| 489 00 08 410 | 12 | 4,3/4 |
| 489 00 08 420 | 17,5 | 6,7/8 |
| 489 00 08 430 | 22 | 8,5/8 |
| 489 00 08 440 | 32 | 12,5/8 |



Macinasale in metacrilato

Acrylic salt mill
Moulin à sel acrylique
Molinillo sal acrílico
Salzmühle, Acryl

| | H. Cm | H. In. |
|---------------|-------|--------|
| 489 00 84 10S | 12 | 4,3/4 |
| 489 00 84 20S | 17,5 | 6,7/8 |
| 489 00 84 30S | 22 | 8,5/8 |
| 489 00 84 40S | 32 | 12,5/8 |



Macinapepe quadro in metacrilato

Square pepper mill, acrylic
Moulin à poivre carré acrylique
Molinillo pimienta cuadrado acrílico
Pfeffermühle quadrat, Acryl

| | H. Cm | H. In. |
|---------------|-------|--------|
| 489 00 00 826 | 14,5 | 5,3/4 |
| 489 00 00 839 | 9 | 3,1/2 |



Macinasale quadro in metacrilato

Square salt mill, acrylic
Moulin à sel carré acrylique
Molinillo sal cuadrado acrílico
Salzmühle quadrat, Acryl

| | H. Cm | H. In. |
|---------------|-------|--------|
| 489 00 08 26S | 14,5 | 5,3/4 |
| 489 00 08 39S | 9 | 3,1/2 |



Macinapepe e noce moscata in metacrilato

Acrylic pepper mill
Moulin à poivre acrylique
Molinillo pimienta acrílico
Pfeffermühle, Acryl

| | H. Cm | H. In. |
|---------------|-------|--------|
| 489 00 00 912 | 8 | 3,1/8 |



Macinasale in metacrilato

Acrylic salt mill
Moulin à sel acrylique
Molinillo sal acrílico
Salzmühle, Acryl

| | H. Cm | H. In. |
|---------------|-------|--------|
| 489 00 09 12S | 8 | 3,1/8 |







Classica

Alpacca Argentata - EPNS

To make a Rubans coffee pot the first step is to shear

the disk (1), that is, a disk of a suitable diameter is cut out of a nickel silver sheet. By means of a die the body is drawn first (2) to get the cylindrical body of the coffee pot; afterwards the body is tapered (3) to obtain the conicity desired. Once the body is ready, the edge is braze-welded (4), and then the body is drilled adequately and the goose-neck is braze-welded (5) too. Afterwards the handle is welded (6). Once the lid is drawn (7), the knob is braze-welded (8) and the hinge is welded to the lid and the body (9). Now the coffee pot is finished. The process ends when the coffee pot is polished and silver-plated (10).

Pour la réalisation d'une cafetière Rubans, on part du

découpage du disque (1), où, à partir de la tôle, on découpe un disque du diamètre opportun en maillechort. Moyennant un moule, on commence d'abord par l'emboutissage du corps (2) jusqu'à l'obtention du corps cylindrique de la cafetière, et ensuite on procède à la striction du corps (3) pour obtenir la conicité désirée. Une fois que le corps a été obtenu, on procède au soudo-brasage du bord (4), puis on troue opportunément le corps et on applique avec soudo-brasage le col de cygne (5). On procède ensuite à la soudure du manche (6). Après l'emboutissage du couvercle (7), on procède au soudo-brasage du pommeau (8) et à la soudure de la charnière au couvercle et au corps (9). À ce point-là, la cafetière est complète : la réalisation se termine par le polissage et l'argenture de l'objet (10).

Para la realización de una cafetera Rubans se comienza

por el troquelado del disco (1), con el que en la chapa se corta un disco de alpaca del diámetro oportuno. Mediante un molde se procede primero a la embutición del cuerpo (2) hasta obtener el cuerpo cilíndrico de la cafetera, y luego se procede a la conificación del cuerpo (3) para obtener la conicidad deseada. Una vez obtenido el cuerpo, se procede a la bronzesoldadura del borde (4), luego se perfora oportunamente el cuerpo y se aplica con bronzesoldadura el cuello de cisne (5). Se procede entonces con la soldadura del mango (6). Después de la embutición de la tapa (7), se procede a la bronzesoldadura del pómulo (8) y con la soldadura de la bisagra a la tapa y al cuerpo (9). A estas alturas la cafetera

Bei der Anfertigung einer Rubans Kaffekanne startet

man mit dem Schnitt der Scheibe (1), d.h. aus dem Alpaka Blech wird eine Scheibe von geeignetem Durchmesser ausgeschnitten. Mit Hilfe eines Gesenks erfolgt dann das Tiefziehen des Körpers (2) bis man den Hohlkörper der Kanne erhält, danach wird der Körper konisch geformt (3) um die gewünschte (Kegelverjüngung) zu erhalten. An dem so erhaltenen Körper nimmt man das Hartlöten des Randes (4) vor, der Körper wird gelocht und der Schwanenhalshahn wird durch Hartlöten angebracht (5). Als nächster Schritt erfolgt das Weichlöten des Griffs (6). Nach Tiefziehen des Deckels (7) wird der Knauf durch Hartlöten angebracht (8) und das Scharnier an Deckel und Körper angelötet (9). Jetzt ist die Kaffekanne fertig und man beginnt mit dem Polieren und Versilbern des Gegenstandes (10).

Alpacca

Fasi di lavorazione

Per la realizzazione di una caffettiera Rubans si parte

dalla tranciatura del disco (1), dove dalla lamiera si va a tranciare un disco del \varnothing opportuno in Alpacca. Mediante uno stampo si procede prima con l'imbutitura del corpo (2) fino ad ottenere il corpo cilindrico della caffettiera, e poi si procede con la conifica del corpo (3), per ottenere la conicità desiderata. Una volta ottenuto il corpo, si procede con la saldobrasatura del bordo (4), poi si fora opportunamente il corpo e si applica la saldobrasatura del collo di cigno (5). Si procede poi con la saldatura del manico (6). Dopo l'imbutitura del coperchio (7), si procede con la saldobrasatura del pomolo (8) e con la saldatura della cerniera al coperchio e al corpo (9). A questo punto la caffettiera è completa: la lavorazione termina con la lucidatura e l'argentatura dell'oggetto (10).

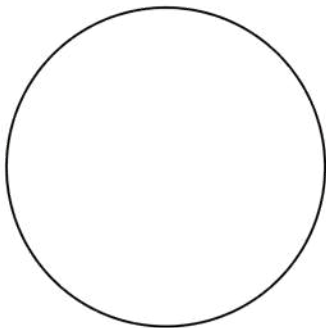

1
Tranciatura
Shearing



2
Imbutitura
Drawing

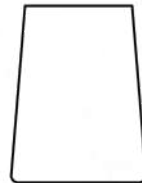

3
Conifica
Tapering

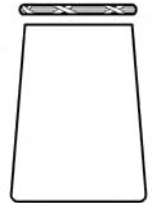

4
Saldobrasatura bordo
Braze-welding

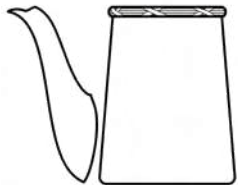

5
Saldobrasatura collo di cigno
Goose-neck braze-welding

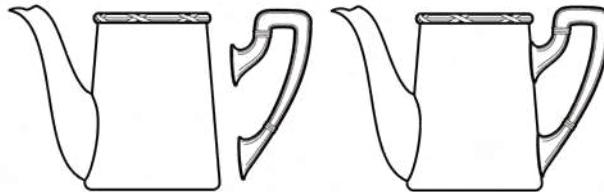

6
Saldatura manico
Handle welding



7
Imbutitura coperchio
Lid drawing

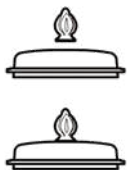

8
Saldobrasatura pomolo
Knob braze-welding



9
Saldatura cerniera
Hinge welding

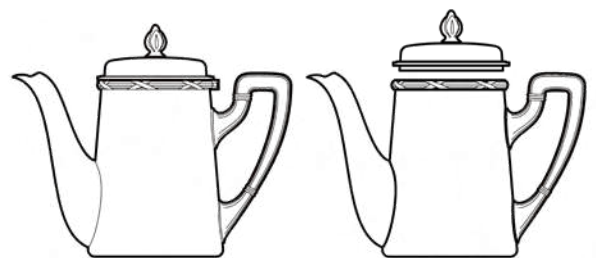

10
Lucidatura e argentatura
Polishing and silver plating

Caffettiera Ambasciata

Ambasciata coffee pot
Cafetière Ambasciata
Cafetera Ambasciata
Kafeekanne Ambasciata

| | Lt | Oz |
|---------------|------|------|
| 310 00 01 567 | 0,40 | 13,5 |
| 310 00 01 578 | 0,85 | 30 |
| 310 00 01 579 | 1,50 | 53 |



Teiera Ambasciata

Ambasciata teapot
Théière Ambasciata
Tetera Ambasciata
Teekanne Ambasciata

| | Lt | Oz |
|---------------|------|----|
| 310 00 02 551 | 0,35 | 12 |
| 310 00 02 552 | 0,75 | 25 |
| 310 00 02 553 | 1,00 | 35 |



Cremiera / lattiera Ambasciata

Ambasciata creamer / milk jug
Crémier / pot à lait Ambasciata
Jarrita de leche / lechera Ambasciata
Milchkanne Ambasciata

| | Lt | Oz |
|---------------|------|------|
| 310 00 03 588 | 0,15 | 6 |
| 310 00 03 589 | 0,40 | 13,5 |
| 310 00 03 590 | 0,70 | 23,5 |



Zuccheriera Ambasciata

Ambasciata sugar bowl
Sucrier Ambasciata
Azucarero Ambasciata
Zuckerdose Ambasciata

| | Lt | Oz |
|---------------|-----|------|
| 310 00 04 503 | 0,2 | 7,05 |



Portazucchero con coperchi

Sugar bowls with covers
Sucriers avec couvercles
Azucareros con tapas
Zuckerdose mit Deckeln

| | H. Cm | H. In. |
|---------------|-------|--------|
| 310 00 04 522 | 12 | 4,3/4 |



Brocca acqua

Water pitcher
Carafe à eau
Jarra agua
Eiswasserkrug

| | Lt | Oz |
|---------------|------|----|
| 310 00 08 532 | 0,70 | 23 |
| 310 00 08 524 | 1,20 | 42 |
| 310 00 08 525 | 1,60 | 54 |



Portasalatini / portazucchero

Snack / sugar holder
Service apéritif / sucrier
Entremesera / azucarero
Salzgebäckschale / Zuckerdose

| | | ø Cm | ø In. |
|---------------|---------------------------|------|-------|
| 310 00 04 524 | 3 comp.-3 dish | 8,5 | 3,3/8 |
| 310 00 41 508 | 4 comp.-4 dish | 8,5 | 3,3/8 |
| 310 09 04 564 | coppetta vetro-glass bowl | | |





Samovar

Samovar

Samovar

Samovar

Samovar

| | H. Cm | Lt | H. In. | Oz |
|---------------|-------|----|--------|----|
| 310 00 02 516 | 46 | 2 | 18,1/8 | 70 |

Passatè con coppetta

Tea strainer with drip bowl
Passoire à thé avec petite coupe
Colador de té con copita
Teesieb mit Schälchen

| | Cm | In. |
|---------------|-----|-----|
| 301 07 91 724 | 7,5 | 3 |



Barella per dolci

Petits fours tray
Petit plateau à petits fours
Bandejita para pasteles
Kuchenplatte

| | Cm | In. |
|---------------|-------|--------------|
| 310 00 41 573 | 22X16 | 8,5/8X6,1/4 |
| 310 00 41 575 | 22X26 | 8,5/8X10,1/4 |



Teiera con scaldino

Teapot with warmer
Théière avec chauffe-plat
Tetera con calentador
Teekanne mit wärmer

| | H. Cm | Cl. | H. In. | Oz |
|---------------|-------|-----|--------|----|
| 310 00 02 552 | 25 | 75 | 9,7/8 | 35 |

Teiera - Teapot

| | H. Cm | ø Cm | H. In. | ø In. |
|---------------|-------|------|--------|-------|
| 310 00 81 702 | 11 | 12 | 4,3/8 | 4,3/4 |

Scaldino - Warmer



Portamarmellata

Jam display
Présentoir à confiture
Soporte mermeladas
Konfitüreschale - Display

| | H. Cm | H. In. |
|---------------|-------|--------|
| 310 00 41 521 | 20 | 7,7/8 |

Con vaso fiori - With flower vase

| | H. Cm | H. In. |
|---------------|-------|--------|
| 310 00 41 509 | 17 | 6,3/4 |

Con pomolo - With knob



Alzata frutta

Fruit stand
 Plat à fruits sur pied
 Frutero
 Obststände

| | ø Cm | ø In. |
|---------------|------|--------|
| 310 00 42 574 | 30 | 11,3/4 |
| 310 00 42 539 | 40 | 15,3/4 |
| 310 00 42 549 | 54 | 21,1/4 |



Alzata frutta

Fruit stand
 Plat à fruits sur pied
 Frutero
 Obststände

| | ø Cm | ø In. | H. Cm | H. In. |
|---------------|------|--------|-------|--------|
| 310 00 42 507 | 25 | 9,7/8 | 12,5 | 4,7/8 |
| 310 00 42 535 | 30 | 11,3/4 | 12,5 | 4,7/8 |



Alzatina piccola pasticceria

Petits fours stand
 Plat à petits fours sur pied
 Soporte pastas de té
 Petits-Fours Ständer

| | ø Cm | ø In. |
|---------------|------|-------|
| 310 00 42 508 | 14 | 5,1/2 |
| 310 00 42 509 | 17 | 6,3/4 |
| 310 00 42 510 | 21 | 8,1/4 |



Alzata torta

Cake stand
 Presentoir à gâteaux
 Soporte pastel
 Tortenplatte

| | ø Cm | ø In. |
|---------------|------|--------|
| 310 00 42 526 | 32 | 12,5/8 |



Alzata frutta 2-3-4 piani

Fruit stand, 2-3-4-tier

Plat à fruits sur pied, 2-3-4 étages

Frutero, 2-3-4 pisos

Obststände, 2-3-4 stufig

| | | ø Cm | H. Cm | ø In. | H. In. |
|---------------|--------------------|-------------|-------|----------------------------|---------|
| 310 00 42 564 | (2 piani / 2 tier) | 30/25 | 49 | 11,3/4-9,7/8 | 19,5/16 |
| 310 00 42 565 | (3 piani / 3 tier) | 40/30/25 | 69 | 15,3/4-11,3/4-9,7/8 | 27 |
| 310 00 42 577 | (3 piani / 3 tier) | 54/40/30 | 69 | 21,1/4-15,3/4-11,3/4 | 27 |
| 310 00 42 571 | (4 piani / 4 tier) | 54/40/30/25 | 90 | 21,1/4-15,3/4-11,3/4-9,7/8 | 35,3/8 |



Macinapepe maxi

Pepper mill, maxi
Moulin à poivre maxi
Molinillo pimienta maxi
Pfeffermühle Maxi

| | H. Cm | H. In. |
|---------------|-------|--------|
| 310 00 12 524 | 15 | 6 |



Macinapepe in legno

Wooden pepper mill
Moulin à poivre en bois
Molinillo pimienta de madera
Holzpeffermühle

| | H. Cm | H. In. |
|---------------|-------|--------|
| 305 04 12 562 | 18 | 7,1/8 |
| 305 04 12 563 | 25 | 9,7/8 |
| 305 04 12 564 | 36 | 14,1/8 |



Spargisale - spargipepe - portastecchi

Salt shaker - Pepper shaker - Toothpick holder
Salière - Poivrière - Porte cure-dents
Salero - Pimentero - Palillero
Pfefferstreuer - Salzstreuer - Zahnstocherträger

| | | | H. Cm | H. In. |
|---|---------------|----------------------------------|-------|--------|
| ① | 310 00 12 545 | Spargipepe Pepper shaker | 9,5 | 3,3/4 |
| ② | 310 00 12 546 | Spargisale Salt shaker | 9,5 | 3,3/4 |
| ③ | 310 00 11 531 | Portastecchi Toothpick holder | 7 | 2,3/4 |



Macinapepe e macinasale in metacrilato argentati

Pepper mill and salt mill, acrylic, EPSS

Moulin à poivre et moulin à sel acryliques argentés

Molinillo pimienta y molinillo sal acrílicos plateados

Pfeffermühle und Salzmühle, Acryl, versilbert

| | | H. Cm | H. In. |
|---------------|--------------------------|-------|--------|
| 305 02 12 560 | Macinasale - Salt mill | 14,5 | 5,3/4 |
| 305 02 12 561 | Macinapepe - Pepper mill | 14,5 | 5,3/4 |
| 305 02 12 602 | Macinasale - Salt mill | 7 | 2,3/4 |
| 305 02 12 603 | Macinapepe - Pepper mill | 7 | 2,3/4 |



Oliera 2 posti luna

Luna oil & vinegar cruet, 2 - piece

Ménagère Luna, 2 pièces

Servicio aceitera vinagrera Luna, 2 piezas

Luna Essig - Ölstander, 2-tlg

| | ø Cm | ø In. |
|---------------|------|-------|
| 310 02 11 526 | 20 | 7,7/8 |



Oliera 2 posti

Oil & vinegar cruet, 2 - piece

Ménagère, 2 pièces

Servicio aceitera vinagrera, 2 piezas

Essig - Ölgestell, 2-tlg

| | H. Cm | H. In. |
|---------------|-------|--------|
| 310 00 11 527 | 22 | 8,5/8 |



Menagere 4 posti luna

Luna oil & vinegar cruet, 4 - piece

Ménagère Luna, 4 pièces

Servicio aceitera vinagrera Luna, 4 piezas

Luna Essig - Ölstander, 4-tlg

| | ø Cm | ø In. |
|---------------|------|-------|
| 310 02 11 521 | 20 | 7,7/8 |



Coppa gelato

Ice cream cup
Coupe à glace
Copa helado
Eisschale

| | ø Cm | ø In. |
|---------------|------|-------|
| 310 00 43 520 | 9 | 3,1/2 |



Coppa cocktail scampi

Shrimp cocktail cup
Coupe à cocktail de crevettes
Copa para cóctel de mariscos
Hummer Cocktailschale

| | ø Cm | ø In. |
|---------------|------|-------|
| 310 00 43 519 | 11 | 4,3/8 |



Coppa multiuso lavadita

Multipurpose bowl / fingerbowl
Coupe multi-usage / rince-doigts
Bol multiuso / lavadedos
Universalschale / fingerschale

| | ø Cm | ø In. |
|---------------|------|-------|
| 310 00 43 528 | 12,5 | 5 |



Coppa gelato

Ice cream cup
Coupe à glace
Copa helado
Eisschale

| | ø Cm | ø In. | H. Cm | H. In |
|---------------|------|-------|-------|-------|
| 310 00 43 627 | 10,5 | 4,1/8 | 9,5 | 3,3/4 |



Formaggiera con manico Luna e Sottocoppa per formaggiera

Grated cheese bowl with Luna handle and underliner
Ravier à parmesan avec poignée Luna et dessous de coupe
Quesera con asa Luna y platito posacopa
Käsedose mit Griff - Luna und Käsedoseuntersatz

| | ø Cm | ø In. |
|------------------------|------|-------|
| 310 00 13 510 | 9 | 3,1/2 |
| Con manico-With handle | | |
| 310 02 22 629 | 13 | 5,1/8 |
| Sottocoppa-Underliner | | |



Formaggiera

Grated cheese bowl
Ravier à parmesan
Quesera
Käsedose

| | ø Cm | ø In. |
|----------------------------|------|-------|
| 310 00 13 515 | 9 | 3,1/2 |
| A cestello - Basket-shaped | | |



Portaburro con coperchio e griglia

Butter cooler with cover and grid
Beurrier avec cloche et plat perforé
Mantequera con tapa y parrilla
Butterkühler

| | | ø Cm | ø In. |
|---------------|--------------------------------------|------|-------|
| 310 00 09 506 | Completa - Whole item | 11 | 4,3/8 |
| 310 00 15 785 | Coperchio - Cover | | |
| 305 07 72 502 | Griglia - Grid | | |
| 310 00 09 554 | Corpo con manici - Bowl with handles | | |



Mostardiera

Mustard pot
Moutardier
Mostacera
Senftopf

| | ø Cm | ø In. |
|---------------|------|-------|
| 310 00 41 535 | 6 | 2,3/8 |

Numero tavola con linguetta

Table number with tab
 Numéro de table à languette
 Número de mesa con lengüeta
 Tischnummer

| | Cm | In. |
|---------------|------|-------------|
| 310 00 19 527 | 11x7 | 4,3/8x2,3/4 |



Tavoletta serigrafata in metacrilato

Small plate, methacrylate
 Plaque en méthacrylate
 Plaquita de metacrilato
 Plexiglas Schild fuer Produktinfo

| | H. Cm | H. In. |
|---------------|-------|---------|
| 305 12 19 525 | 12x18 | 4,3/4x7 |



Portanumero da tavola

Table number stand
 Support numéro de table
 Soporte número de mesa
 Tischnummerständer

| | H. Cm | H. In. |
|---------------|-------|--------|
| 305 07 19 524 | 30 | 11,3/4 |

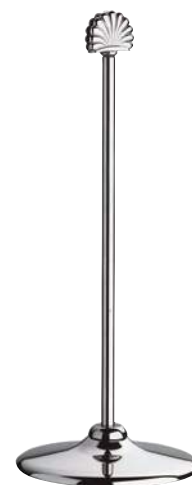

Lampada da tavolo

Candle lamp
 Lampe à bougie
 Lampara de vela
 Windlicht mit Kristall

| | | H. Cm | H. In. |
|---------------|--|-------|--------|
| 310 00 17 502 | Con candela With candle | 18 | 7 |
| 310 00 17 530 | Con combustibile liquido With liquid fuel | 18 | 7 |
| 310 12 17 530 | Ricambio combustibile liquido Spare liquid fuel | | |
| 310 31 81 655 | Candela Candle | | |
| 310 09 17 505 | Ricambio cristallo Lamp shade spare part | | |



Vasetto portafiori

Flower vase
Vase à fleurs
Florero
Blumenvase

| | H. Cm | H. In. |
|---------------|-------|--------|
| 310 00 19 506 | 18 | 7 |



Legatovagliolo

Napkin ring
Rond de serviettes
Servilletero redondo
Serviettenring

| | Cm | In. |
|---------------|-----|-------|
| 310 02 71 791 | 4,5 | 1,3/4 |



Portatovaglioli

Napkin holder
Porte-serviettes en papier
Servilletero
Serviettenhälter

| | Cm | In. |
|---------------|----|-----|
| 310 00 71 525 | 5 | 2 |



Portatovaglioli

Napkin holder
Porte-serviettes en papier
Servilletero
Serviettenhälter

| | Cm | In. |
|---------------|-------|-------------|
| 310 02 71 945 | 19x19 | 7,1/2x7,1/2 |



Classica



Cestino pane a filo

Bread basket, wire
Corbeille à pain tressé
Cesta pan de malla
Drahtbrotkorb

| | Cm | In. |
|---------------|---------------|-----------------|
| 310 07 24 520 | 18 x 25 x 6,5 | 7x9,7/8 x 2,1/2 |



Cestino pane con piede

Bread basket, footed
Corbeille à pain sur pied
Cesta pan con pie
Brotkorb mit Fuß

| | ø Cm | H. Cm | ø In. | H. In. |
|---------------|------|-------|-------|--------|
| 310 00 24 554 | 19 | 8 | 7,1/2 | 3,1/8 |
| 310 00 24 555 | 23 | 8 | 9 | 3,1/8 |



Salsiera

Sauce boat
Saucière
Salsera
Sauciere

| | Cl. | Oz |
|---------------|-----|--------|
| 310 00 12 532 | 15 | 6 |
| 310 00 12 533 | 23 | 9 |
| 310 00 12 534 | 44 | 17,3/8 |



Raccoglibriciole a pala

Crumb sweeper
Pelle ramasse-miettes
Pala recogemigas
Krümelsammler

| | Cm | In. |
|---------------|----|--------|
| 310 00 71 528 | 30 | 11,3/4 |

Portauovo

Egg cup
Coquetier
Huevera
Eierbecher

| | H. Cm | In. |
|---------------|-------|-------|
| 310 00 71 953 | 7 | 2,3/4 |



Servitore per the / pasticceria

Afternoon tea stand
Support pour service à thé
Soporte expositor platos postre
Tee/Kuchenstander

| | ø Cm | H. Cm | ø In. | H. In. |
|---|------|-------|--------|--------|
| Con pomolo per piatti - With knob for dishes | | | | |
| ø Cm 25 - 28 | | | | |
| 301 07 42 529 | 29 | 42 | 11,1/2 | 16,1/2 |
| ø Cm 20 - 24 | | | | |
| 301 07 42 533 | 25 | 38 | 9,7/8 | 15 |
| Senza pomolo per piatti - Without knob for dishes | | | | |
| ø Cm 25 - 28 | | | | |
| 301 07 42 573 | 29 | 39 | 11,1/2 | 15,3/8 |
| ø Cm 20 - 24 | | | | |
| 301 07 42 572 | 25 | 35 | 9,7/8 | 13,3/4 |



Cloche in acciaio argentato

Dome cover, electro-plated stainless steel (EPSS)
Cloche en acier argenté
Campana en acero plateado
Speiseglocke, Edelstahl versilbert

| | ø Cm int. | ø Cm est. | ø In. int. | ø In. est. |
|---------------|-----------|-----------|------------|------------|
| 310 07 53 554 | 18 | 20,5 | 7 | 8 |
| 310 07 53 555 | 22 | 24 | 8,5/8 | 9,1/2 |
| 310 07 53 556 | 24 | 26 | 9,1/2 | 10,1/4 |
| 310 07 53 562 | 28 | 30 | 11 | 11,3/4 |
| 310 07 53 569 | 30 | 32 | 11,3/4 | 12,5/8 |





Piatto presentazione decoro Rubans

Show plate, Rubans decoration

Plat de présentation, décor Rubans

Plato de presentación, decoración Rubans

Platzteller - Dekor Rubans

| | ø Cm | ø In. |
|---------------|------|--------|
| 310 00 25 525 | 32 | 12,5/8 |



Piatto presentazione decoro Impero

Show plate, Impero decoration

Plat de présentation, décor Impero

Plato de presentación, decoración Impero

Platzteller - Dekor Impero

| | ø Cm | ø In. |
|---------------|------|--------|
| 310 00 25 515 | 32 | 12,5/8 |



Piatto presentazione decoro inglese

Show plate, stainless steel, English decoration

Plat de présentation, décor anglais

Plato de presentación, decoración inglesa

Platzteller - Dekor English

| | ø Cm | ø In. |
|---------------|------|--------|
| 310 00 25 518 | 32,5 | 12,3/4 |



Piatto presentazione decoro barocco

Show plate, Baroque decoration

Plat de présentation, décor baroque

Plato de presentación, decoración barroca

Platzteller - Dekor Barock

| | ø Cm | ø In. |
|---------------|------|--------|
| 310 00 25 512 | 30 | 11,3/4 |

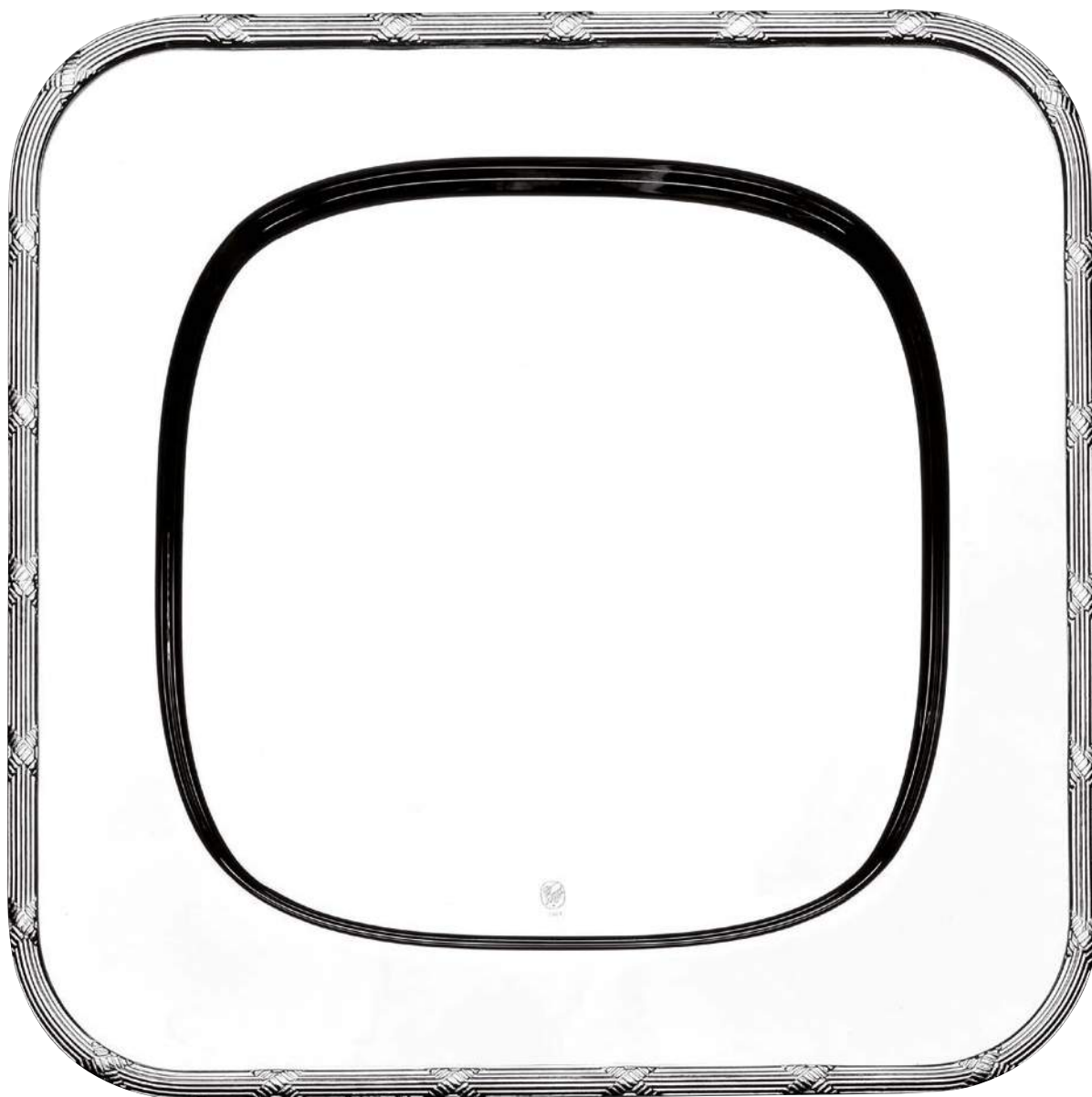

Piatto presentazione quadro

Show plate, square

Plat de présentation, carré

Plato de presentación, cuadrado

Platzteller - quadrat

| | Cm | In. |
|---------------|---------|-----------------|
| 310 00 25 539 | 32 x 32 | 12,5/8 x 12,5/8 |



Supporto secchio champagne ovale

Champagne bucket stand
Support pour seau à champagne
Soporte para champañera
Weinkühlerstände

| | | | |
|---------------|--------------|-------|--------|
| 310 00 20 520 | Ovale - Oval | H. Cm | H. In. |
| | | 67 | 26,3/8 |



Supporto secchio champagne

Champagne bucket stand
Support pour seau à champagne
Soporte para champañera
Weinkühlerstände

| | | | |
|---------------|---------------|-------|--------|
| 310 00 20 519 | Tondo - Round | H. Cm | H. In. |
| | | 68 | 26,3/4 |



Secchio champagne ovale 2 bottiglie

Champagne bucket - oval, 2 - bottle
Seau à champagne oval, 2 bouteilles
Champañera oval, 2 botellas
Ovalweinkühler, 2 Flaschen

| | H. Cm | H. In. |
|---------------|-------|--------|
| 310 00 20 516 | 22 | 8,5/8 |



Secchiello ghiaccio e secchio champagne con pomoli

Ice bucket and champagne bucket with knobs
Seau à glace et seau à champagne avec poignées
Cubo hielo y champañera con pomos
Eis / Sektkühler

| | ø Cm | ø In. |
|---------------|------|-------|
| 310 00 20 524 | 12 | 4,3/4 |
| 310 00 20 515 | 20 | 7,7/8 |



Secchio champagne Medici

Medici Champagne bucket
Seau à champagne Medici
 Champañera Medici
 Weinkühler Medici

| | ø Cm | H. Cm | ø In. | H. In. |
|---------------|------|-------|-------|--------|
| 310 00 20 644 | 22 | 26 | 8,5/8 | 10,1/4 |



Secchiello ghiaccio e secchio champagne con anelli

Ice bucket and champagne bucket with rings
Seau à glace et seau à champagne à anneaux
 Cubo hielo y champañera con anillos
 Eis / Sektkühler

| | ø Cm | ø In. |
|---------------|------|-------|
| 310 00 20 522 | 12 | 4,3/4 |
| 310 00 20 512 | 20 | 7,7/8 |

Classica

Secchio champagne Magnum

Magnun Champagne cooler
Seau à champagne Magnum
Champañera Magnum
Magnum Champagnekühler

| | Cm | H. Cm | In | H. In |
|---------------|-------|-------|---------------|-------|
| 310 00 20 673 | 44x27 | 25 | 17,3/8x10,5/8 | 9,7/8 |



Versavino a filo

Red wine holder, wire
Panier à vin tressé
Cesta de vino de malla
Drahtweinkorb

| | Cm | In. |
|---------------|----|-------|
| 310 07 24 522 | 25 | 9,7/8 |



Versavino

Red wine holder
Porte-bouteille
Portabotella
Rotweinwiege

| | Cm | In. |
|---------------|----|--------|
| 301 07 24 532 | 30 | 11,3/4 |



Glacette

Bottle cooler
Rafraîchisseur à bouteille
Enfriador de botella
Weinkühler

| | | H. Cm | H. In. |
|---------------|------------------------------|-------|--------|
| 305 02 24 517 | Con pomoli - With knobs | 24 | 9,1/2 |
| 305 02 24 536 | Senza pomoli - Without knobs | 24 | 9,1/2 |

**Scaldabrandy**

Brandy warmer
Réchaud à brandy
Calentador para brandy
Brandywärmer

| | H. Cm | H. In. |
|---------------|-------|--------|
| 305 02 52 521 | 14 | 5,1/2 |

**Decanter vetro**

Decanter, glass
Décanteur en verre
Decantador de cristal
DekantierKaraffe

| | Lt | Oz |
|---------------|-----|----|
| 405 62 01 500 | 1,5 | 53 |

**Portadecanter in acciaio**

Decanter stand, stainless steel
Egouttoir à carafe en acier inoxydable
Soporte para decantador en acero inoxidable
Karaffentrockner, Edelstahl

| | H. Cm | H. In. |
|---------------|-------|--------|
| V01 05 24 020 | 30 | 11,3/4 |

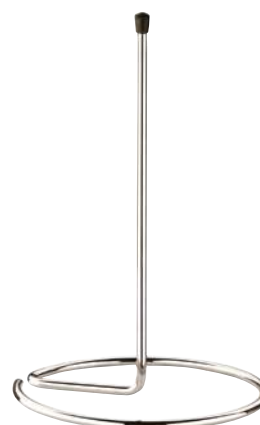



Zuppiera

Soup tureen
Soupière
Sopera
Suppensschüssel

| | ø Cm | ø In. |
|---------------|------|--------|
| 310 00 15 670 | 16 | 6,1/4 |
| 310 00 15 671 | 22 | 8,5/8 |
| 310 00 15 672 | 26 | 10,1/4 |

Coperchio - Cover

| | | |
|---------------|----|--------|
| 310 00 15 673 | 16 | 6,1/4 |
| 310 00 15 674 | 22 | 8,5/8 |
| 310 00 15 675 | 26 | 10,1/4 |



Legumiera

Vegetable dish
Légumier
Legumbrera
Gemüseschüssel

| | ø Cm | ø In. |
|---------------|------|--------|
| 310 00 15 601 | 16 | 6,1/4 |
| 310 00 15 602 | 22 | 8,5/8 |
| 310 00 15 603 | 26 | 10,1/4 |

Coperchio - Cover

| | | |
|---------------|----|--------|
| 310 00 15 673 | 16 | 6,1/4 |
| 310 00 15 674 | 22 | 8,5/8 |
| 310 00 15 675 | 26 | 10,1/4 |



Coppa punch in acciaio argentato

Punch bowl, electro-plated stainless steel (EPSS)
Bol à punch en acier argenté
Champañera en acero plateado
Punchschale, versilbert

| | ø Cm | ø In. | Lt | Oz |
|---------------|------|--------|----|-----|
| 310 00 43 570 | 40 | 15,3/4 | 13 | 439 |



Padella flambé

Flambé pan
 Poêle à flamber
 Sartén para flambear
 Flambierpfanne

| | ø Cm | ø In. |
|---------------|------|--------|
| 305 07 72 543 | 30 | 11,3/4 |



Fornello flambé a gas

Flambé burner, gas
 Réchaud à flamber, gaz
 Hornillo para flambear, gas
 Flambierrechaud, Gaskocher

| | H. Cm | H. In. |
|---------------|-------|--------|
| 310 00 52 502 | 30 | 11,3/4 |

Molla formaggio parmigiano

Cheese tongs
Pince à fromage
Pinzas para queso
Käsezange

| | Cm | In. |
|---------------|----|-------|
| 310 00 81 530 | 13 | 5,1/8 |



Grattugia formaggio

Cheese grater
Râpe à fromage
Rallador
Reibeisen

| | Cm | In. |
|---------------|----|-------|
| 310 00 71 521 | 24 | 9,1/2 |



Tagliatartufi maxi

Truffle cutter, maxi
Coupe-truffes maxi
Cortatrufas maxi
Trüffelschneider, Maxi

| | Cm | In. |
|---------------|----|-------|
| 310 00 91 517 | 25 | 9,7/8 |





Vassoio tondo

Tray, round
 Plateau rond
 Bandeja redonda
 Tablett, rund

| | ø Cm | ø In. |
|---------------|------|--------|
| 310 02 23 542 | 30 | 11,3/4 |
| 310 02 23 544 | 43 | 17 |



Piattino pane

Bread plate
 Plat à pain
 Plato pan
 Brotteller

| | ø Cm | ø In. |
|---------------|------|-------|
| 310 00 22 674 | 15 | 6 |

Decoro inglese - English decoration



Piattino pane

Bread plate
 Plat à pain
 Plato pan
 Brotteller

| | ø Cm | ø In. |
|---------------|------|-------|
| 310 00 22 680 | 16 | 6,1/4 |

Decoro Impero - Impero decoration



Piattino pane decoro Rubans

Bread plate
 Plat à pain
 Plato pan
 Brotteller

| | ø Cm | ø In. |
|---------------|------|-------|
| 310 00 23 764 | 16 | 6,1/4 |



Piatto ovale bordo rinforzato

Oval plate, reinforced edge
 Plat oval, bord renforcé
 Fuente oval, borde reforzado
 Tablett, oval

| | Cm | In. |
|---------------|-----------|-----------------|
| 310 00 22 594 | 27 x 18 | 10,5/8 x 7 |
| 310 00 22 595 | 33 x 22 | 13 x 8,5/8 |
| 310 00 22 597 | 38 x 25,5 | 15 x 10 |
| 310 00 22 600 | 44 x 29,5 | 17,3/8 x 11,5/8 |
| 310 00 22 603 | 49 x 32,5 | 19,1/4 x 12,3/4 |
| 310 00 22 609 | 60 x 40 | 23,5/8 x 15,3/4 |



Vassoio rettangolare serie marina

Marina rectangular tray
 Plateau rectangulaire Marina
 Bandeja rectangular Marina
 Tablett, rechteckig, Marina

| | Cm | In. |
|---------------|---------|---------------|
| 310 00 23 864 | 35 x 25 | 13,3/4x9,7/8 |
| 310 00 23 865 | 40 x 30 | 15,3/4x11,3/4 |
| 310 00 23 871 | 45 x 35 | 17,34x13,3/4 |
| 310 00 23 866 | 55 x 45 | 21,5/8x17,3/4 |
| 310 00 23 556 | 62 x 48 | 24,3/8 x 19 |



Piatto tondo bordo rinforzato

Round plate, reinforced edge
 Plat rond, bord renforcé
 Fuente redonda, borde reforzado
 Brattenplatte, rund

| | ø Cm | ø In. |
|---------------|------|--------|
| 310 00 22 568 | 22 | 8,5/8 |
| 310 00 22 570 | 27 | 10,5/8 |
| 310 00 22 572 | 33 | 13 |
| 310 00 22 574 | 38 | 15 |



Piatto pesce bordo rinforzato

Fish platter, reinforced edge
 Plat à poisson, bord renforcé
 Fuente pescado, borde reforzado
 Fischplatte

| | Cm | In. |
|---------------|---------|-----------------|
| 310 00 22 615 | 90 x 35 | 35,3/8 x 13,3/4 |

Vassoio rettangolare serie marina con maniglie bordo rinforzato

Marina rectangular tray with handles, reinforced edge

Plateau rectangulaire Marina avec poignées, bord renforcé

Bandeja rectangular Marina con asas, borde reforzado

Tablett mit Griff, Marina

| | Cm | In. |
|---------------|---------|---------------|
| 310 00 23 867 | 35 x 25 | 13,3/4x9,7/8 |
| 310 00 23 868 | 40 x 30 | 15,3/4x11,3/4 |
| 310 00 23 869 | 45 x 35 | 17,3/4x13,3/4 |



| | Cm | In. |
|---------------|---------|---------------|
| 310 00 23 870 | 55 x 45 | 21,5/8x17,3/4 |
| 310 00 23 551 | 62 x 48 | 24,3/8 x 19 |



Piatto tondo bordo rivoltato

Round plate, turned edge
 Plat rond, bord retourné
 Fuente redonda, borde revuelto
 Brattenplatte, rund

| | ø Cm | ø In. |
|---------------|------|--------|
| 310 00 22 564 | 29 | 11,1/2 |
| 310 00 22 565 | 34 | 13,3/8 |
| 310 00 22 566 | 38 | 15 |



Piatto ovale bordo rivoltato

Oval plate, turned edge
 Plat oval, bord retourné
 Fuente oval, borde revuelto
 Brattenplatte, oval

| | Cm | In. |
|---------------|---------|-----------------|
| 310 00 22 580 | 25 x 17 | 9,7/8 x 6,3/4 |
| 310 00 22 582 | 29 x 20 | 11,1/2 x 7,7/8 |
| 310 00 22 584 | 34 x 23 | 13,3/8 x 9 |
| 310 00 22 586 | 38 x 26 | 15 x 10,1/4 |
| 310 00 22 587 | 44 x 29 | 17,3/8 x 11,1/2 |
| 310 00 22 589 | 48 x 33 | 19 x 13 |
| 310 00 22 591 | 59 x 40 | 23,1/4 x 15,3/4 |



Vassoio rettangolo bordo inglese

Small change tray
 Plateau porte-monnaie
 Bandeja portamoneda
 Geldplatte

| | Cm | In. |
|---------------|---------|----------------|
| 310 00 23 798 | 26 x 14 | 10,1/4 x 5,1/2 |



Vassoio tondo bordo inglese

Tray with English edge, round
 Plateau rond avec rebord anglais
 Bandeja redonda con borde inglés
 Tablett, rund

| | ø Cm | ø In. |
|--------------------------------|------|--------|
| Senza manici - Without handles | | |
| 310 00 23 785 | 35 | 13,3/4 |
| 310 00 23 786 | 45 | 17,3/4 |
| Con manici - With handles | | |
| 310 00 23 787 | 35 | 13,3/4 |
| 310 00 23 788 | 45 | 17,3/4 |



Vassoio rettangolare bordo inglese

Tray with English edge, rectangular
 Plateau rectangulaire avec rebord anglais
 Bandeja rectangular con borde inglés
 Tablett, rechteckig

| | Cm | In. |
|--------------------------------|---------|-----------------|
| Senza manici - Without handles | | |
| 310 00 23 760 | 37 x 27 | 14,1/2 x 10,5/8 |
| 310 00 23 762 | 46 x 36 | 18,1/8 x 14,1/8 |
| 310 00 23 781 | 55 x 41 | 21,5/8 x 16,1/8 |

| | | |
|---------------------------|---------|-----------------|
| Con manici - With handles | | |
| 310 00 23 782 | 37 x 27 | 14,1/2 x 10,5/8 |
| 310 00 23 783 | 46 x 36 | 18,1/8 x 14,1/8 |
| 310 00 23 784 | 55 x 41 | 21,5/8 x 16,1/8 |

**Vassoio ovale bordo inglese**

Tray with English edge, oval
 Plateau oval avec rebord anglais
 Bandeja oval con borde inglés
 Tablett, oval

| | Cm | In. |
|--------------------------------|---------|-----------------|
| Senza manici - Without handles | | |
| 310 00 23 757 | 39 x 29 | 15,3/8 x 11,1/2 |
| 310 00 23 759 | 46 x 36 | 18,1/8 x 14,1/8 |
| 310 00 23 777 | 55 x 41 | 21,5/8 x 17 |

| | | |
|---------------------------|---------|-----------------|
| Con manici - With handles | | |
| 310 00 23 778 | 39 x 29 | 15,3/8 x 11,1/2 |
| 310 00 23 779 | 46 x 36 | 18,1/8 x 14,1/8 |
| 310 00 23 780 | 55 x 43 | 21,5/8 x 17 |





**Candelabro
11 / 13 luci
Ambasciata**

Ambasciata candelabrum, 11/13-light
Candélabre Ambasciata 11/13 lumières
Candelabro Ambasciata 11/13 luces
11/13-armig, Kerzenleuchter Ambasciata

| | H. Cm | H. In. |
|--------------------|-------|--------|
| 310 00 18 543 (11) | 82 | 32,1/4 |
| 310 00 18 544 (13) | 97 | 38,1/4 |



**Candelabro
5 luci
Ambasciata**

Ambasciata candelabrum, 5-light
Candélabre Ambasciata 5 lumières
Candelabro Ambasciata 5 luces
5-armig, Kerzenleuchter Ambasciata

| | H. Cm | H. In. |
|---------------|-------|--------|
| 310 02 18 537 | 46 | 18,1/8 |



**Candeliere
1 luce**

Candlestick, 1-light
Flambeau 1 lumière
Candelero 1 luz
1-armig, Leuchter

| | H. Cm | H. In. |
|---------------|-------|--------|
| 310 00 18 512 | 7 | 2,3/4 |
| 310 00 18 510 | 21 | 8,1/4 |
| 310 00 18 539 | 25 | 9,7/8 |



**Candelabro
3 luci**

Candelabrum, 3-light
Candélabre 3 lumières
Candelabro 3 luces
3-armig, Kerzenleuchter

| | H. Cm | H. In. |
|---------------|-------|--------|
| 310 00 18 508 | 40 | 15,3/4 |



**Candelabro
5 luci**

Candelabrum, 5-light
Candélabre 5 lumières
Candelabro 5 luces
5-armig, Kerzenleuchter

| | H. Cm | H. In. |
|---------------|-------|--------|
| 310 00 18 509 | 40 | 15,3/4 |



**Candeliere basso
1 luce
Ambasciata**

Ambasciata candlestick, short, 1-light
Flambeau Ambasciata bas 1 lumière
Candelero Ambasciata bajo 1 luz
1-armig, Leuchter Ambasciata, klein

| | H. Cm | H. In. |
|---------------|-------|--------|
| 310 00 18 545 | 23 | 9 |



**Candelabro basso
3 luci
Ambasciata**

Ambasciata candelabrum, short, 3-light
Candélabre Ambasciata bas 3 lumières
Candelabro Ambasciata bajo 3 luces
3-armig, Kerzenleuchter Ambasciata, klein

| | H. Cm | H. In. |
|---------------|-------|--------|
| 310 00 18 546 | 36 | 14,1/8 |



**Candelabro basso
5 luci
Ambasciata**

Ambasciata candelabrum, short, 5-light
Candélabre Ambasciata bas 5 lumières
Candelabro Ambasciata bajo 5 luces
5-armig, Kerzenleuchter Ambasciata, klein

| | H. Cm | H. In. |
|---------------|-------|--------|
| 310 00 18 547 | 36 | 14,1/8 |



Rubans
Alpacca Argentata - EPNS



Rubans



Caffettiera Rubans con beccuccio

Rubans goose-neck coffee pot
Cafetière Rubans avec bec
Cafetera Rubans de pico
Kaffeekanne Rubans - mit Schnäbelchen

| | Lt | Oz |
|---------------|------|--------|
| 310 00 01 530 | 0,24 | 8 |
| 310 00 01 532 | 0,48 | 16 |
| 310 00 01 535 | 0,72 | 24 |
| 310 00 01 537 | 0,96 | 33,3/4 |
| 310 00 01 540 | 1,40 | 49 |



Caffettiera Rubans con nasello

Rubans coffee pot
Cafetière Rubans
Cafetera Rubans
Kaffeekanne Rubans

| | Lt | Oz |
|---------------|------|--------|
| 310 00 01 554 | 0,24 | 8 |
| 310 00 01 556 | 0,48 | 16 |
| 310 00 01 575 | 0,72 | 24 |
| 310 00 01 576 | 0,96 | 33,3/4 |
| 310 00 01 577 | 1,40 | 49 |



Teiera Rubans con beccuccio

Rubans goose neck pot
Theière Rubans avec bec
Tetera Rubans de pico
Teekanne Rubans - mit Schnäbelchen

| | Lt | Oz |
|---------------|------|----|
| 310 00 02 524 | 0,30 | 10 |
| 310 00 02 526 | 0,50 | 18 |
| 310 00 02 528 | 0,75 | 25 |
| 310 00 02 530 | 1,00 | 35 |



Teiera Rubans con nasello

Rubans teapot
Theière Rubans
Tetera Rubans
Teekanne Rubans

| | Lt | Oz |
|---------------|------|----|
| 310 00 02 543 | 0,30 | 10 |
| 310 00 02 544 | 0,50 | 18 |
| 310 00 02 545 | 0,75 | 25 |
| 310 00 02 546 | 1,00 | 35 |



Cremiera / lattiera Rubans

Rubans creamer / milk pot
 Crémier / pot à lait Rubans
 Jarrita de leche / lechera Rubans
 Gießler / Milchkanne Rubans

| | Lt | Oz |
|---------------|------|--------|
| 310 00 03 530 | 0,15 | 6 |
| 310 00 03 544 | 0,24 | 8 |
| 310 00 03 546 | 0,48 | 16 |
| 310 00 03 548 | 0,72 | 24 |
| 310 00 03 550 | 0,96 | 33,3/4 |
| 310 00 03 552 | 1,40 | 49 |



Portamarmellata con anello Rubans

Rubans jam display with ring
 Présentoir à confiture avec anneau Rubans
 Soporte mermeladas con anillo Rubans
 Konfitüreschale Rubans

| | H. Cm | H. In. |
|---------------|-------|--------|
| 310 00 09 555 | 17 | 6,3/4 |



Zuccheriera Rubans

Rubans sugar bowl
 Sucrier Rubans
 Azucarero Rubans
 Zuckerdose Rubans

| | Gr. | Oz |
|---------------|-----|-------|
| 310 00 04 532 | 140 | 4,90 |
| 310 00 04 534 | 250 | 8,75 |
| 310 00 04 536 | 360 | 12,60 |
| 310 00 04 538 | 540 | 18,90 |



Portasalatini / portazucchero Rubans

Rubans snack / sugar holder
 Service coupelles / sucrier Rubans
 Entremesera / azucarero Rubans
 Salzgebäckschale / Zuckerdose Rubans

| | ø Cm | H. Cm | ø In. | H. In. |
|---------------------|-----------------------------|-------|-------|--------|
| 310 00 41 538 | 9 | 18 | 3,1/2 | 7 |
| 3 comparti - 3 dish | | | | |
| 310 00 41 539 | 9 | 18 | 3,1/2 | 7 |
| 4 comparti - 4 dish | | | | |
| 310 09 04 564 | Coppetta vetro - Glass bowl | | | |

Rubans

Secchio spumante 1/2 - bottiglie Rubans

Rubans champagne bucket, 1/2 - bottle
Seau à champagne Rubans, 1/2 bouteilles
Cubo champán Rubans, 1/2 botellas
Sektkühler 1/2 Flaschen Rubans

| | ø Cm | H. Cm | ø In. | H. In. |
|---------------|------|-------|-------|--------|
| 310 00 20 558 | 21 | 22,5 | 8,1/4 | 8,7/8 |



Secchio ghiaccio Rubans

Rubans ice bucket
Seau à glace Rubans
Cubo hielo Rubans
Eis kühler Rubans

| | ø Cm | H. Cm | ø In. | H. In. |
|---------------|------|-------|-------|--------|
| 310 00 20 654 | 14 | 15 | 5,1/2 | 6 |



Supporto secchio spumante Rubans

Rubans champagne bucket stand
Support pour seau à champagne Rubans
Soporte para cubo champán Rubans
Weinkühlerständer Rubans

| | H. Cm | H. In. |
|---------------|-------|--------|
| 310 00 20 560 | 65 | 25,5/8 |



Secchio ghiaccio termico / Sorbettiera con coperchio Rubans

Rubans thermal ice bucket / Sherbet pot with cover
 Seau à glace isotherme / Sorbetière avec couvercle Rubans
 Cubo hielo térmico / Sorbetera con tapa Rubans
 Eis/SorbettKühler mit Deckel Rubans

| | ø Cm | H. Cm | ø In. | H. In. |
|---------------|------|-------|-------|--------|
| 310 00 20 653 | 14 | 17 | 5,1/2 | 6,3/4 |

Secchio ghiaccio - Ice bucket

| | | | | |
|---------------|----|----|-------|-------|
| 310 00 21 529 | 14 | 17 | 5,1/2 | 6,3/4 |
|---------------|----|----|-------|-------|

Sorbettiera - Sherbet pot



Servizio caviale Rubans

Rubans caviar service set
 Service à caviar Rubans
 Servicio de caviar Rubans
 Kaviar-Set Rubans

| | ø Cm | H. Cm | ø In. | H. In. |
|---------------|------|-------|-------|--------|
| 310 00 42 588 | 16 | 9,5 | 6,1/4 | 3,3/4 |

Per contenitori standard

For standard containers

| | | | | |
|---------------|----|-----|-------|-------|
| 310 00 42 591 | 16 | 9,5 | 6,1/4 | 3,3/4 |
|---------------|----|-----|-------|-------|

Con coppa in cristallo

With crystal bowl



Coppa punch con manici Rubans

Punch bowl with Rubans handles
 Bol à punch avec poignées Rubans
 Champañera con asas Rubans
 Punschschale mit Griff Rubans

| | ø Cm | Lt | ø In. | Oz |
|---------------|------|----|--------|------|
| 310 00 43 602 | 50 | 30 | 19,3/4 | 1014 |



Rubans

Legatovagliolo Rubans

Rubans napkin ring
Anneau porte-serviettes Rubans
Servilletero redondo Rubans
Serviettenring Rubans

| | Cm | In. |
|---------------|----|-----|
| 310 00 81 644 | 5 | 2 |



Portatoasts Rubans

Rubans toast rack
Porte-toasts Rubans
Portatostadas Rubans
Toastständer Rubans

| | Cm | H. Cm | ø In. | H. In. |
|---------------|----|-------|-------|--------|
| 310 00 71 883 | 16 | 13 | 6,1/4 | 5,1/8 |



Lampada da tavolo

Candle lamp
Lampe à bougie
Lampara de vela
Windlicht mit Kristall

| | | H. Cm | H. In. |
|---------------|--|-------|--------|
| 310 00 17 502 | Con candela With candle | 18 | 7 |
| 310 00 17 530 | Con combustibile liquido With liquid fuel | 18 | 7 |
| 310 12 17 530 | Ricambio combustibile liquido Spare liquid fuel | | |
| 310 31 81 655 | Candela Candle | | |
| 310 09 17 505 | Ricambio cristallo Lamp shade spare part | | |



Fruttiera Rubans

Rubans fruit bowl
 Coupe à fruits Rubans
 Frutero Rubans
 Fruchtschale Rubans

| | ø Cm | ø In. |
|---------------|------|-------|
| 310 00 42 575 | 22 | 8,5/8 |



Cloche Rubans (acciaio argentato)

Rubans dome cover, electro-plated stainless steel
 Cloche Rubans en acier argenté
 Cúpula Rubans en acero plateado
 Cloche Rubans - versilbert

| | ø Cm int. | ø Cm est. | ø In. int. | ø In. est. |
|---------------|-----------|-----------|------------|------------|
| 310 07 53 591 | 18 | 20,5 | 7 | 8 |
| 310 07 53 592 | 22 | 24 | 8,5/8 | 9,1/2 |
| 310 07 53 593 | 24 | 26 | 9,1/2 | 10,1/4 |
| 310 07 53 594 | 28 | 30 | 11 | 11,3/4 |
| 310 07 53 595 | 30 | 32 | 11,3/4 | 12,5/8 |



Cestino pane Rubans

Rubans bread basket
 Corbeille à pain Rubans
 Cesta pan Rubans
 Brotkorb Rubans

| | ø Cm | H. Cm | ø In. | H. In. |
|---------------|------|-------|-------|--------|
| 310 00 24 539 | 19 | 8 | 7,1/2 | 3,1/8 |
| 310 00 24 543 | 23 | 8 | 9 | 3,1/8 |



Rubans



Vassoietto portaconto Rubans

Rubans tip tray
Plateau porte-addition Rubans
Bandeja para cuentas Rubans
Geld / Rechnungstablett Rubans

| | Cm | In. |
|---------------|---------|----------------|
| 310 00 23 754 | 26 x 16 | 10,1/4 x 6,1/4 |

Vassoio tondo Rubans

Rubans tray, round
Plateau rond Rubans
Bandeja redonda Rubans
Tablett Rubans, rund

| | Ø Cm est. | Ø In. est. |
|--------------------------------|-----------|------------|
| Senza manici - Without handles | | |
| 310 00 23 734 | 37 | 14,1/2 |
| 310 00 23 735 | 48 | 19 |

| | | |
|---------------------------|----|--------|
| Con manici - With handles | | |
| 310 00 23 746 | 37 | 14,1/2 |
| 310 00 23 747 | 48 | 19 |

Vassoio ovale Rubans

Rubans tray, oval
Plateau oval Rubans
Bandeja oval Rubans
Tablett Rubans, oval

| | Cm | In. |
|--------------------------------|---------|-----------------|
| Senza manici - Without handles | | |
| 310 00 23 748 | 40 x 28 | 15,3/4 x 11 |
| 310 00 23 750 | 50 x 36 | 19,3/4 x 14,1/8 |

| | | |
|---------------------------|---------|-----------------|
| Con manici - With handles | | |
| 310 00 23 749 | 40 x 28 | 15,3/4 x 11 |
| 310 00 23 751 | 50 x 36 | 19,3/4 x 14,1/8 |

Vassoio rettangolare Rubans

Rubans tray, rectangular
Plateau rectangulaire Rubans
Bandeja rectangular Rubans
Tablett Rubans, rechteckig

| | Cm | In. |
|--------------------------------|-----------|-----------------|
| Senza manici - Without handles | | |
| 310 00 23 745 | 40 x 30 | 15,3/4 x 11,3/4 |
| 310 00 23 744 | 55 x 41 | 21,5/8 x 16,1/8 |
| 310 00 23 743 | 64 x 43,5 | 25,1/4 x 17,1/8 |

| | | |
|---------------------------|-----------|-----------------|
| Con manici - With handles | | |
| 310 00 23 753 | 40 x 30 | 15,3/4 x 11,3/4 |
| 310 00 23 752 | 55 x 41 | 21,5/8 x 16,1/8 |
| 310 00 23 736 | 64 x 43,5 | 25,1/4 x 17,1/8 |



Oliera due posti Gallery

Oil and vinegar cruet, 2 piece
Ménagère, 2 pieces
Servicio aceitera vinagrera
Serviettenring Rubans

| | Cm | H Cm | In | H. In |
|---------------|------------|------|-------------|--------|
| 310 00 11 622 | 14,5 x 6,5 | 30 | 5,3/4x2,3/8 | 11,3/4 |



Portabustine Gallery

Gallery sugar-bag holder, rectangular
Sucrier rectangulaire Gallery
Azucarero rectangular Gallery
Zuckerbehälter

| | Cm | In. |
|---------------|-------|---------------|
| 310 00 41 571 | 9 x 7 | 3,1/2 x 2,3/4 |



Vassoio con portabustine Rubans / Gallery

Rubans / Gallery tray with sugar-bag holders
Plateau avec sucriers Rubans / Gallery
Bandeja con azucareros Rubans / Gallery
Tablett mit Zuckerbehälter, Rubans / Gallery

| | Cm | In. |
|---------------|---------|----------------|
| 310 00 04 575 | 26 x 16 | 10,1/4 x 6,1/4 |



Sottobottiglia Gallery

Gallery bottle coaster
Sous-bouteille Gallery
Posa botella Gallery
Flaschenuntersatz

| | ø Cm | H. Cm | ø In. | H. In. |
|---------------|------|-------|-------|--------|
| 316 02 21 529 | 10 | 4,5 | 4 | 1,3/4 |



Cestino pane Gallery

Gallery bread basket
Corbeille à pain Gallery
Cesta pan Gallery
Brotkorb Gallery

| | ø Cm | ø In. |
|---------------|------|-------|
| 310 00 24 548 | 19 | 7,1/2 |
| 310 00 24 547 | 23 | 9 |



Porta macinini Rubans / Gallery

Rubans / Gallery tray with sugar-bag holders
Plateau avec sucriers Rubans / Gallery
Bandeja con azucareros Rubans / Gallery
Tablett mit Zuckerbehälter, Rubans / Gallery

| | | Cm | In. |
|---------------|--------------------------|-------|---------------|
| 310 00 12 628 | Cestino | 7 x 4 | 2,3/4 x 1,1/2 |
| 305 02 12 602 | Macinasale - Salt mill | 7 | 2,3/4 |
| 305 02 12 603 | Macinapepe - Pepper mill | 7 | 2,3/4 |





Buffet





Nature Buffet



Nature

Alzata torta in noce bassa

Cake stand, walnut

Présentoir à gâteaux en bois de noyer

Presentación tarta en madera de nogal

Tortenplatte Walnussholz

Noce - Walnut

| | ø Cm | ø In | h. Cm | h. In |
|------------------------|------|------|-------|-------|
| 305 54 42 673 (small) | 28 | 11 | 14 | 5,5 |
| 305 54 42 674 (medium) | 33 | 12,9 | 14 | 5,5 |
| 305 54 42 675 (large) | 37 | 14,5 | 14 | 5,5 |



Alzata torta in noce alta

Cake stand, walnut

Présentoir à gâteaux en bois de noyer

Presentación tarta en madera de nogal

Tortenplatte Walnussholz

Noce - Walnut

| | ø Cm | ø In | h. Cm | h. In |
|------------------------|------|------|-------|-------|
| 305 54 42 676 (small) | 28 | 11 | 21 | 8,2 |
| 305 54 42 677 (medium) | 33 | 12,9 | 21 | 8,2 |
| 305 54 42 678 (large) | 37 | 14,5 | 21 | 8,2 |



**Coperchio a bascula
adatto per alzate ø37cm
suitable for stands ø37cm**

Transparent round rolltop cover
Cloche basculante ronde transparente
Rolltophaube - rund
Campana redonda transparente

SAN

| | ø Cm | ø In |
|---------------|------|--------|
| V76 12 15 T01 | 34 | 13,3/8 |



**Cupola in vetro
adatto per alzate ø28cm
suitable for stands ø28cm**

Dome cover, glass
Cloche en verre
Campana de vidrio
Cloche aus Glas

Vetro - Glass

| | ø Cm | ø In |
|---------------|------|------|
| 404 10 42 610 | 25 | 9,8 |



**Cupola in policarbonato
adatto per alzate ø28cm
suitable for stands ø28cm**

Dome cover, acrylic
Cloche en acrylique
Campana de acrilico
Cloche aus Polycarbonat

Polycarbonato - Polycarbonat

| | ø Cm | ø In |
|---------------|------|------|
| 305 12 53 625 | 26 | 10,2 |



Nature

Alzata pasticceria Noce

Cake stand, walnut

Présentoir à gâteaux en bois de noyer

Soporte pasteles en madera de nogal

Tortenplatte Walnussholz

Noce - Walnut

| | ø Cm | h. Cm | ø In | h. In |
|---------------|------|-------|-------|-------|
| 305 54 42 692 | 16 | 9 cm | 6,1/4 | 3,1/2 |



Alzata pasticceria 2 piani

Petit fours stand

Plat à petits fours sur pied

Petit Four Stand

Soporte pasteles

Noce - Walnut

| | h. Cm | h. In |
|-------------------------|-----------|-------|
| 305 54 42 671 (2 posti) | 23,5x24,4 | 12 |



Alzata pasticceria 3 piani

Petit fours stand

Plat à petits fours sur pied

Petit Four Stand

Soporte pasteles

Noce - Walnut

| | h. Cm | h. In |
|-------------------------|---------|-------|
| 305 54 42 670 (3 posti) | 43x41,5 | 12 |



Piattino rettangolare

Rectangular plate - Plato rectangular

Plat rectangulaire - Rechteckige Teeller

Porcellana - Porcelain

| | Cm | In |
|---------------|-------|-------|
| 264 00 42 669 | 18x11 | 7x4,3 |



Ciotolina a goccia

Bowl - Bol

Bol - Schüssel

Porcellana - Porcelain

V87 21 42 001

| Cm | In |
|-------|---------|
| 8x7x4 | 3,1x1,5 |



Piattino quadrato porcellana

Square saucer - Platillo cuadrado

Soucoupe carrée - Quadratische teller

Porcellana - Porcelain

| | Cm | In |
|---------------|-------|---------|
| 322 21 22 691 | 10x10 | 3,9x3,9 |



Coppetta rotonda

Round bowl - Bol redondo

Bol rond - Runde Schüssel

Porcellana - Porcelain

V87 21 42 005

| ø Cm | ø In |
|------|------|
| 7 | 2,7 |





Distributore Aqva con base in marmo di Carrara

Aqva dispenser with Carrara marble stand
 Distributeur Aqva avec support en Carrara marbre
 Dispensador Aqva con soporte en Carrara mármol
 Getränkespender Aqva mit Ständer aus Carrara Marmor

Marmo di Carrara e vetro - Carrara Marble and glass

| | h. Cm | h. In |
|---------------|-------|-------|
| 305 54 52 729 | 63 | 24.8 |

Distributore Aqva con base in noce

Aqva dispenser with walnut wood stand
 Distributeur Aqva avec support en bois de noyer
 Dispensador Aqva con soporte en madera de nogal
 Getränkespender Aqva mit Ständer aus Walnussholz

Noce e vetro - Walnut and glass

| | h. Cm | h. In |
|---------------|-------|-------|
| 305 54 52 728 | 63 | 24.8 |







Nature



Piano in noce massello

Solid walnut wood top

Dessus en bois massif noyer

Tabla de madera maciza de nogal

Top Walnuss massiv

| | Cm | In |
|---------------|--------|---------------|
| 305 54 42 629 | 30x30 | 11,3/4x11,3/4 |
| 305 54 42 630 | 70x30 | 27,1/2x11,3/4 |
| 305 54 42 631 | 100x30 | 39,3/8x11,3/4 |



Piano in ardesia

Slate top

Dessus en ardoise

Tabla de pizarra

Top Schiefer

| | Cm | In |
|---------------|--------|---------------|
| V87 09 42 Q01 | 30x30 | 11,3/4x11,3/4 |
| V87 09 42 R01 | 70x30 | 27,1/2x11,3/4 |
| V87 09 42 R02 | 100x30 | 39,3/8x11,3/4 |



Piano in pietra lavica

Lava top

Dessus en pierre de lave

Tabla de piedra lávica

Top Lavastein

| | Cm | In |
|---------------|--------|---------------|
| 305 60 42 633 | 30x30 | 11,3/4x11,3/4 |
| 305 60 42 634 | 70x30 | 27,1/2x11,3/4 |
| 305 60 42 635 | 100x30 | 39,3/8x11,3/4 |



Vassoio per alzate rettangolare

Tray for podia, rectangular
 Plateau pour supports rectangulaire
 Bandeja rectangular para soportes
 Tablett Walnuss, rechtekig

Noce - Walnut

| | Cm | H | In | H |
|---------------|---------|-----|---------------|-------|
| 305 54 23 854 | 35x52,5 | 4,5 | 13,3/4x20,5/8 | 1,3/4 |

**Vassoio per alzate rettangolare**

Tray for podia, rectangular
 Plateau pour supports rectangulaire
 Bandeja rectangular para soportes
 Tablett Walnuss, rechtekig

Noce - Walnut

| | Cm | H | In | H |
|---------------|---------|---|---------------|-------|
| 305 54 23 855 | 35x52,5 | 8 | 13,3/4x20,5/8 | 3,1/8 |

**Vassoio per alzate rettangolare**

Tray for podia, rectangular
 Plateau pour supports rectangulaire
 Bandeja rectangular para soportes
 Tablett Walnuss, rechtekig

Noce - Walnut

| | Cm | H | In | H |
|---------------|-----------|-----|--------------|-------|
| 305 54 23 853 | 17,5x52,5 | 4,5 | 6,7/8x20,5/8 | 1,3/4 |

**Base inclinata per vassoi**

Inclined base for rectangular trays
 Base inclinée pour plateaux rectangulair
 Base inclinada para bandejas
 Basistablett mit Kante rechteckig

Noce - Walnut

| | Cm | H | In | H |
|---------------|---------|-----|---------------|-------|
| 305 54 23 856 | 35x52,5 | 6,7 | 13,3/4x20,5/8 | 2,1/2 |



Nature

Alzata quadrata nera opaca

Square podium

Support carré

Soporte cuadrado

Podest quadratisch

NERA OPACA - matte black

| | Cm | H | In | H |
|---------------|-------|----|-----|--------|
| 305 44 42 621 | 18x18 | 20 | 7x7 | 7,7/8 |
| 305 44 42 622 | 18x18 | 25 | 7x7 | 9,7/8 |
| 305 44 42 623 | 18x18 | 30 | 7x7 | 11,3/4 |

CROMATA - cromed

| | Cm | H | In | H |
|---------------|-------|----|-----|--------|
| 305 05 42 621 | 18x18 | 20 | 7x7 | 7,7/8 |
| 305 05 42 622 | 18x18 | 25 | 7x7 | 9,7/8 |
| 305 05 42 623 | 18x18 | 30 | 7x7 | 11,3/4 |



Alzata rettangolare

Rectangular podium

Support rectangulaire

Soporte rectangular

Podest rechteckig

NERA OPACA - matte black

| | Cm | H | In | H |
|---------------|-----------|------|--------------|-------|
| 305 44 42 625 | 17,5x52,5 | 13,5 | 6,7/8x20,5/8 | 5,3/4 |
| 305 44 42 626 | 17,5x52,5 | 20 | 6,7/8x20,5/8 | 7,7/8 |

CROMATA - cromed

| | Cm | H | In | H |
|---------------|-----------|------|--------------|-------|
| 305 05 42 625 | 17,5x52,5 | 13,5 | 6,7/8x20,5/8 | 5,3/4 |
| 305 05 42 626 | 17,5x52,5 | 20 | 6,7/8x20,5/8 | 7,7/8 |



Alzata rettangolare

Rectangular podium

Support rectangulaire

Soporte rectangular

Podest rechteckig

NERA OPACA - matte black

| | Cm | H | In | H |
|---------------|---------|------|---------------|-------|
| 305 44 42 627 | 35x52,5 | 13,5 | 13,3/4x20,5/8 | 5,3/4 |
| 305 44 42 628 | 35x52,5 | 20 | 13,3/4x20,5/8 | 7,7/8 |

CROMATA - cromed

| | Cm | H | In | H |
|---------------|---------|------|---------------|-------|
| 305 05 42 627 | 35x52,5 | 13,5 | 13,3/4x20,5/8 | 5,3/4 |
| 305 05 42 628 | 35x52,5 | 20 | 13,3/4x20,5/8 | 7,7/8 |

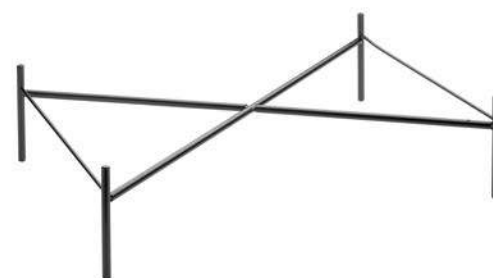

Alzata rettangolare per porcellane

Rectangular podium for porcelain items

Support rectangulaire pour articles en porcelaine

Soporte rectangular para artículos de porcelana

Podest rechteckig für Artikel aus Porzellan

NERA OPACA - matte black

| | Cm | H | In | H |
|---------------|-------|------|--------------|-------|
| 305 44 42 624 | 12x40 | 13,5 | 4,3/4x15,3/4 | 5,3/4 |
| 305 44 42 632 | 12x40 | 20 | 4,3/4x15,3/4 | 7,7/8 |

CROMATA - cromed

| | Cm | H | In | H |
|---------------|-------|------|--------------|-------|
| 305 05 42 624 | 12x40 | 13,5 | 4,3/4x15,3/4 | 5,3/4 |
| 305 05 42 632 | 12x40 | 20 | 4,3/4x15,3/4 | 7,7/8 |





Cestino pane per alzata quadrata

Bread basket for square podium
Corbeille à pain pour support carré
 Cesta para pan para soporte cuadrado
 Brotkorb für Podium quadratisch

Misto lino - Linen blend

| | Cm | H | In | H |
|---------------|-------|----|-----|-------|
| 305 29 24 588 | 18x18 | 20 | 7x7 | 7,7/8 |



Alzata quadrata nera opaca

Matte black square podium
Support carré noir
 Soporte cuadrado negro mate
 Podest quadratisch Schwarz

| | Cm | H | In | H |
|---------------|-------|----|-----|--------|
| 305 44 42 621 | 18x18 | 20 | 7x7 | 7,7/8 |
| 305 44 42 622 | 18x18 | 25 | 7x7 | 9,7/8 |
| 305 44 42 623 | 18x18 | 30 | 7x7 | 11,3/4 |



Cestino pane per alzata rettangolare

Bread basket for rectangular podium
Corbeille à pain pour support rectangulaire
 Cesta para pan para soporte rectangular
 Brotkorb für Podium rechteckig cm

Misto lino - Linen blend

| | Cm | H | In | H |
|---------------|-----------|------|--------------|-------|
| 305 29 24 589 | 17,5x52,5 | 13,5 | 6,7/8x20,5/8 | 5,3/4 |
| 305 29 24 590 | 17,5x52,5 | 20 | 6,7/8x20,5/8 | 7,7/8 |



Alzata rettangolare nera opaca

Matt black rectangular podium
Support rectangulaire noir
 Soporte rectangular negro mate
 Podest rechteckig Schwarz

| | Cm | H | In | H |
|---------------|-----------|------|--------------|-------|
| 305 44 42 625 | 17,5x52,5 | 13,5 | 6,7/8x20,5/8 | 5,3/4 |
| 305 44 42 626 | 17,5x52,5 | 20 | 6,7/8x20,5/8 | 7,7/8 |



Nature



Base legno per 3 ciotole in porcellana

Wood base fitting 3 porcelain bowls
 Base en bois pour 3 bols en porcelaine
 Base de madera para 3 boles de porcelana
 Holzbasis für 3 Porzellan Bols

Noce - Walnut

| | Cm | H | In | H |
|---------------|-----------|-----|--------------|---|
| 305 54 54 608 | 17,5x52,5 | 2,5 | 6,7/8x20,5/8 | 1 |



Ciotola Artesano

Artesano bowl
 Bol Artesano
 Bol Artesano
 Artesano bol

Porcellana - Porcelain

| | Lt | Oz |
|---------------|-----|----|
| 264 02 51 900 | 0,6 | 21 |



Ciotola Urban

Urban bowl
 Bol Urban
 Bol Urban
 Urban bol

Porcellana - Porcelain

| | Lt | Oz |
|---------------|-----|----|
| 263 45 21 900 | 0,6 | 21 |



Base in legno con 3 fori

Wood base with 3 holes

Base en bois avec 3 trous

Base de madera con 3 agujeros

Holzbasis mit 3 runden Ausschnitten

Noce - Walnut

| | Cm | H | In | H |
|---------------|-----------|-----|--------------|---|
| 305 54 54 609 | 17,5x52,5 | 2,5 | 6,7/8x20,5/8 | 1 |

**Vaso in vetro con coperchio**

Glass jar with lid

Pot en verre avec couvercle

Jarrón de vidrio con tapa

Glasdose mit Deckel

Vetro - Glass

| | ø Cm | H | In | H |
|---------------|------|----|-------|-------|
| 404 10 31 304 | 14 | 19 | 5,1/2 | 7,1/2 |

**Coppetta affinity**

Affinity bowl

Bol Affinity

Bol Affinity

Affinity Bol

Porcellana - Porcelain

| | ø Cm | ø In |
|---------------|------|------|
| 264 00 43 800 | 15 | 6 |

**Coperchio per coppetta in vetro**

Lid for glass bowl

Couvercle pour bol en verre

Tapa para bol de vidrio

Deckel für Glasschale

Inox 18/10 - St. Steel

| | ø Cm | ø In |
|---------------|------|------|
| B01 12 52 640 | 15 | 6 |

**Coppetta in vetro**

Glass bowl

Bol en verre

Bol de vidrio

Glasschale

Vetro - Glass

| | ø Cm | ø In |
|---------------|------|------|
| V76 08 52 004 | 15 | 6 |







Nature

Piatto ovale Artesano

Artesano oval bowl
Coupe ovale Artesano
Plato oval Artesano
Artesano Schale oval

Porcellana - Porcelain

| | Cm | In |
|---------------|-------|--------------|
| 264 02 53 844 | 55x17 | 21,5/8x6,3/4 |



Piatto servire BBQ

BBQ platter
Plat à servir BBQ
Fuente para servir BBQ
BBQ Platte

Porcellana - Porcelain

| | Cm | In |
|---------------|-------|--------------|
| 264 18 92 906 | 55x22 | 21,5/8x6,3/4 |



Insalatiera Artesano

Artesano salad bowl
Saladier Artesano
Ensaladera Artesano
Artesano Schüssel rund

Porcellana - Porcelain

| | ø Cm | ø In |
|---------------|------|------|
| 264 02 53 170 | 28 | 11 |



Piatto presentazione Artesano

Artesano presentation bowl
Coupe présentation Artesano
Plato presentación Artesano
Artesano Präsentationsschale rund

Porcellana - Porcelain

| | ø Cm | ø In |
|---------------|------|--------|
| 264 02 53 760 | 37 | 14,1/2 |





Alzata rettangolare per porcellane

Rectangular podium for porcelain items
 Support rectangulaire pour articles en porcelaine
 Soporte rectangular para artículos de porcelana
 Podest rechteckig für Artikel aus Porzellan

Nero opaco - Matte black

| | Cm | H | In | H |
|---------------|-------|------|--------------|-------|
| 305 44 42 624 | 12x40 | 13,5 | 4,3/4x15,3/4 | 5,3/4 |
| 305 44 42 632 | 12x40 | 20 | 4,3/4x15,3/4 | 7,7/8 |

Cromato - Chromed

| | Cm | H | In | H |
|---------------|-------|------|--------------|-------|
| 305 05 42 624 | 12x40 | 13,5 | 4,3/4x15,3/4 | 5,3/4 |
| 305 05 42 632 | 12x40 | 20 | 4,3/4x15,3/4 | 7,7/8 |



Alzata quadrata

Square podium
 Support carré
 Soporte cuadrado
 Podest quadratisch

Nero opaco - Matte black

| | Cm | H | In | H |
|---------------|-------|----|-----|--------|
| 305 44 42 621 | 18x18 | 20 | 7x7 | 7,7/8 |
| 305 44 42 622 | 18x18 | 25 | 7x7 | 9,7/8 |
| 305 44 42 623 | 18x18 | 30 | 7x7 | 11,3/4 |

Cromato - Chromed

| | Cm | H | In | H |
|---------------|-------|----|-----|--------|
| 305 05 42 621 | 18x18 | 20 | 7x7 | 7,7/8 |
| 305 05 42 622 | 18x18 | 25 | 7x7 | 9,7/8 |
| 305 05 42 623 | 18x18 | 30 | 7x7 | 11,3/4 |









Secchio champagne

Champagne bucket
Seau à champagne
Cubo champàn
Champagnerkühler

Tiglio - Lime wood

| | ø Cm | ø In |
|---------------|------|-------|
| 305 54 43 628 | 20 | 7,7/8 |



Coppa punch

Punch bucket
Bol à punch
Champañera
Punch Bol mit Einsatz

Tiglio - Lime wood

| | øCm | ø In |
|---------------|-----|--------|
| 305 54 43 629 | 40 | 15,3/4 |



Tagliere con cinghia acciaio

Cutting board with st. steel belt

*Planche à découper**Tabla de cortar con cinturón de acero**Schneidbrett mit Edelstahlband***Noce - Walnut**

| | ø Cm | ø In |
|---------------|------|--------|
| 305 04 71 980 | 40 | 15,3/4 |

**Tagliere pane in noce**

Cutting board, walnut wood

*Planche à découper**Brottschneidebrett Walnussholz**Tabla de cortar*

| | Cm | In |
|--|---------|-----------|
| Tagliere e vassoio - Cutting board with tray | | |
| 305 54 54 618 | 52.5x35 | 20,6x13,7 |

| | | |
|--------------------------|---------|-----------|
| Tagliere - Cutting board | | |
| 305 54 54 617 | 52.5x35 | 20,6x13,7 |

| | | |
|----------------|---------|-----------|
| Vassoio - Tray | | |
| 305 54 23 854 | 52.5x35 | 20,6x13,7 |

**Vassoio refrigerato**

Thermal tray

*Plateau réfrigéré**Bandeja refrigerada**Thermo-Platte***Noce - Walnut**

| | Cm | In |
|---------------|-----------|---------------|
| 305 54 52 730 | 52,5x32,5 | 20,5/8x12,3/4 |





Set piastra con alzata

Hot buffet set with podium
 Buffet chaud avec support
 Set plancha con soporte
 Hot Buffet Set mit Podest

Nero opaco - Matte black

| | Cm | H | In | H |
|---------------|-----------|------|--------------|-------|
| 305 44 54 614 | 17,5x52,5 | 13,5 | 6,7/8x20,5/8 | 5,3/4 |

Cromato - Chromed

| | Cm | H | In | H |
|---------------|-----------|------|--------------|-------|
| 305 05 54 614 | 17,5x52,5 | 13,5 | 6,7/8x20,5/8 | 5,3/4 |

Piastra teflonata

Non-stick baking tray
 Plateau antiadhésif
 Plancha teflonada
 Anti-haft Aufsatz

Alluminio - Aluminum

| | Cm | In |
|---------------|---------|--------------|
| 305 05 72 764 | 16x52,5 | 6,1/4x20,5/8 |

Cornice per piastra teflonata

Frame for non-stick baking tray
 Cadre pour plateau antiadhésif
 Marco para plancha teflonada
 Rahmen für Anti-haft Aufsatz

Noce - Walnut

| | Cm | In |
|---------------|-----------|--------------|
| 305 54 54 610 | 17,5x52,5 | 6,7/8x20,5/8 |

Supporto per portalumini

Stand for candle holders
 Support pour portes-bougies
 Soporte para portavelas
 Gestell für Teelichthalter

Acciaio inox 18/10 - St. Steel

305 05 20 671

Alzata rettangolare

Rectangular podium
 Support rectangulaire
 Soporte rectangular
 Podest rechteckig

Nero opaco - Matte black

| | Cm | H | In | H |
|---------------|-----------|------|--------------|-------|
| 305 44 42 625 | 17,5x52,5 | 13,5 | 6,7/8x20,5/8 | 5,3/4 |

Cromato - Chromed

| | Cm | H | In | H |
|---------------|-----------|------|--------------|-------|
| 305 05 42 625 | 17,5x52,5 | 13,5 | 6,7/8x20,5/8 | 5,3/4 |

Portalumini

Candle holder
 Porte-bougies
 Portavelas
 Teelichthalter

Acciaio inox 18/10 - St. Steel

305 05 52 614



Cavalletto portaetichetta per buffet

Buffet easel for tags

Chevalet porte-nom pour buffet

Soporte caballete para etiqueta para buffet

Aufsteller Produktinfo

Acciaio inox 18/10 - St. Steel

| | Cm | H | In | H |
|---------------|-----|----|-------------|---|
| V01 05 19 001 | 7x7 | 15 | 2,3/4x2,3/4 | 6 |

Tavoletta nera per cavalletto

Black tag for easel

Plaque noire pour chevalet

Etiqueta negra para soporte caballete

Schild für Produktinfo

Plexiglass

| | Cm | In |
|---------------|--------|-----|
| V01 12 19 001 | 10x7,5 | 4x3 |



Nature

Distributore succhi

Thermal juice dispenser
Distributeur de jus réfrigéré
Dispensador de zumo refrigerado
Thermo-Saftspender

Noce - Walnut

| | Lt | Oz | Cm | H | In | H |
|---------------|-----|-------|---------|----|----------|--------|
| 305 54 52 644 | 3,5 | 122,5 | 23x32 | 48 | 9x12,5/8 | 19 |
| 305 54 52 633 | 7 | 245 | 28x35,5 | 53 | 11x14 | 20,7/8 |



Distributore caffè

Coffee urn
Distributeur de café
Dispensador de café
Kaffeespender

Noce - Walnut

| | Lt | Oz | Cm | H | In | H |
|---------------|----|-----|---------|----|-------|--------|
| 305 54 52 631 | 7 | 245 | 28x35,5 | 54 | 11x14 | 21,1/4 |
| 305 54 52 632 | 10 | 350 | 28x35,5 | 62 | 11x14 | 24,3/8 |



Distributore cereali

Cereal dispenser
Distributeur céréales
Dispensador cereales
Cerealienspender 1-fach

Noce - Walnut

| | Lt | Oz | Cm | H | In | H |
|---------------|----|-------|-------|----|--------|----|
| 305 54 52 636 | 4 | 122,5 | 23x32 | 56 | 9x12,5 | 22 |



Rinfrescaraffe 4 comparti

Thermal pitcher, 4-pc set
Rafraîchisseur à 4 carafes
Enfriador para 4 jarras
Thermo-Karaffehatter 4 Stck.

Noce - Walnut

| | Cm | H | In | H |
|---------------|-------|---|-------|-------|
| 305 54 24 586 | 28x28 | 9 | 11x11 | 3,1/2 |



Caraffa vetro con coperchio basculante

Water glass pitcher with smart lid
Carafe en verre avec couvercle basculant
Jarra de vidrio con tapa basculante
Wasser Karaffe mit Kippen Kappe

| | Lt | Oz |
|---------------|----|----|
| 305 05 08 548 | 1 | 35 |



Rinfrescaraffe 2 comparti

Double thermal pitcher
Rafraîchisseur à 2 carafes
Enfriador para 2 jarras
Thermo-Karaffenthaler 2 Stck.

Noce - Walnut

| | Cm | In |
|---------------|-----------|--------------|
| 305 54 52 634 | 21,5x38,5 | 8,1/2x15,1/8 |



Caraffa succhi con coperchio

Juice pitcher with lid
Carafe à jus avec couvercle
Jarra zumo con tapa
Saftkrug mit Deckel

| | Lt | Oz |
|---------------|-----|----|
| 305 05 08 539 | 1,5 | 53 |



Nature

Vassoio formaggi refrigerato

Thermal cheese/cold cuts tray
Plateau à fromage/charcuterie réfrigéré
Bandeja quesos/embutidos refrigerada
Thermo-Aufschnittplatte

Noce - Walnut

| | Cm | H | In | H |
|---------------|---------|------|---------------|-------|
| 305 54 54 577 | 52x32,5 | 21,5 | 20,5/8x12,3/4 | 8,1/2 |



Vassoio refrigerato

Thermal tray, ice packs on demand
Plateau réfrigéré, blocs réfrigérants sur demande
Bandeja refrigerada, acumuladores de frío disponibles
Thermo-Platte, Kühlelemente auf Anfrage

Noce - Walnut

| | Cm | H | In | H |
|---------------|-----------|---|---------------|-------|
| 305 54 52 699 | 52.5x32.5 | 4 | 20,5/8x12,3/4 | 1,5/8 |



Vassoio yogurt refrigerato con ghiaccio

Zeta ice thermal yogurt tray
Plateau à yaourts réfrigéré à glace Zeta
Bandeja yogures refrigerable con hielo Zeta
Joghurtablett Zeta, mit Eis kühlbar

Noce - Walnut

| | Cm | H | In | H |
|---------------|-----------|---|---------------|-------|
| 305 54 52 638 | 52.5x32.5 | 4 | 20,5/8x12,3/4 | 1,5/8 |



Coppa macedonia

Thermal fruit salad bowl
Rafraîchisseur salade de fruits
Bol macedonia de frutas refrigerado
Thermo-Fruchtsalatschale

Noce - Walnut

| | Cm | In |
|---------------|-------|-------|
| 305 54 52 641 | 28x28 | 11x11 |



Set 2 coppe yogurt

Thermal yogurt set, 2-bowl
Set 2 bols yaourt réfrigérés
Set 2 boles yogur refrigerados
Thermo-Schalen 2 Stck.

Noce - Walnut

| | Cm | In |
|---------------|-----------|--------------|
| 305 54 52 640 | 21,5x38,5 | 8,1/2x15,1/8 |



Jambee distributore marmellata/miele con base in legno

Jambee jam/honey dispenser with wood base
Distributeur confiture/miel Jambee avec base en bois
Jambee distribuidor de mermelada/miel con base de madera
Jambee Konfitür/honigspender mit Holzbasis

Noce - Walnut

| | Lt | Oz | Cm | In |
|---------------|-----|------|------------|--------------|
| 305 05 52 721 | 0,7 | 23 | 12,5x34,5 | 5x13,5/8 |
| | | | H Min 40,5 | H Min 16 |
| | | | H Max 54 | H Max 21,1/4 |
| 305 05 52 722 | 1 | 33,8 | 12,5x34,5 | 5x13,5/8 |
| | | | H Min 48 | H Min 18,7/8 |
| | | | H Max 70 | H Max 27,1/2 |



Jambee



Un oggetto **elegante e contemporaneo**, adatto a ogni tipo di buffet: grazie al design unico e innovativo.

I materiali usati sono di **alto livello qualitativo** - acciaio Inox 18/10 e metacrilato - e rendono il distributore un oggetto pregiato.

MADE IN ITALY

La **tecnologia semplice**, ma al tempo stesso funzionale, permette di erogare dosi da 8gr (0.28 oz) di prodotto, riducendo gli sprechi ed eliminando le monoporzioni da 25gr (0.88 oz).

Questo consente un risparmio di prodotto e la riduzione dei rifiuti nel

rispetto dell'ambiente. Inoltre è ideale per servire miele e marmellate di produzione artigianale, per fornire un prodotto di alto livello e che soddisfi anche i clienti più esigenti.

Un ottimo modo per arricchire l'esperienza della colazione, mantenendo **ordinato e pulito** il buffet.

Utilizzabile con prodotti erogabili semisolidi, come confetture, marmellate - pure con piccoli frammenti di frutta - e creme, ma anche con miele, sciroppi e salse di analoga consistenza.

Jambee è l'ideale per **ogni struttura ricettiva**: alberghi, pasticcerie, bar e ristoranti.



An **elegant and modern** object for all buffets, thanks to its unique and innovative design.

The materials used are **high quality** - 18/10 stainless steel and methacrylate - which makes the dispenser a fine object.

MADE IN ITALY

Its **simple technology**, though functional, allows to dispense 8 gr (0.28 oz) product doses, to reduce waste and get rid of 25 gr (0.88 oz) single dose jars.

That allows, as well, to save on product and reduce waste, respecting

the environment. Moreover, it is the ideal to dispense honey and homemade jams, in order to supply for a high-end product, capable of meeting even the most demanding customers' needs.

The best way to make the most of the breakfast experience, keeping the buffet **tidy and clean**.

It can be used with dispensable semisolid products like preserves, marmalades - even with small fruit pieces in them - , creams and honey, syrups and sauces as well, which have the same consistency.

Jambee is the ideal for **any accommodation facility**: hotels, pastry shops, bars and restaurants.

Jambee

Pistone con coperchio

Piston with lid
Piston avec couvercle
Kolben mit Deckel
Pistón con tapa

Inox 18/10, Metacrilato e PP - St. Steel, Methacrylate and PP

| | Lt |
|---------------|-----|
| Z77 9852 DMA | 0,7 |
| Z77 9852 DMA1 | 1 |

Contentore

Container
Conteneur
Behälter
Contenedor

Metacrilato - Methacrylate

| | Lt |
|---------------|-----|
| Z77 2052 DMA | 0,7 |
| Z77 2052 DMA1 | 1 |

Tappo

Cap
Capsule
Stöpsel
Tapón

Metacrilato - Methacrylate

Z77 1352 DMA

Contentore completo

Complete container
Conteneur complet
Komplett Behälter
Contenedor completo

Metacrilato - Methacrylate

| | Lt |
|---------------|-----|
| Z77 9952 DMA | 0,7 |
| Z77 9952 DMA1 | 1 |

Targhetta porta etichetta

Label plate
Plaque porte-étiquette
Schild Etikettenhalter
Placa porta etiqueta

Metacrilato - Methacrylate

Z77 5752 DMA

Targhetta porta etichetta

Label plate
Plaque porte-étiquette
Schild Etikettenhalter
Placa porta etiqueta

Metacrilato - Methacrylate

Z77 5752 DMA1



Jambee

Jambee
Jambee
Jambee
Jambee

Acciaio Inox 18/10 - St. Steel

| | Lt | Oz | Cm | In |
|--------------|-----|------|-----------------------------------|--|
| V77 0552 DMB | 0,7 | 23 | 12,5x34,5 H Min 39 H Max 54 | 5x13,5/8 H Min 15,3/8 H Max 21,1/4 |
| V77 0552 DMC | 1 | 33,8 | 12,5x34,5 H Min 47 H Max 69 | 5x13,5/8 H Min 18,1/2 H Max 27,1/8 |



Erogatore a siringa

Syringe nozzle
Embout seringue
AusgieBerspritze
Boquilla jeringa

Inox 18/10 - St. Steel

Z77 4652 DMA



Erogatore standard

Standard nozzle
Embout standard
Standard AusgieBer
Boquilla estandar

Inox 18/10 - St. Steel

Z77 4552 DMA







Aqva

AQVA





Distributore bevande riscaldato

Heated beverage dispenser
Distributeur de boissons chauffé
Dispensador de bebidas calentado
Getränkspender, aufgewärmt

| | Lt | Oz | H. Cm. | H. In. |
|---------------|----|-----|--------|--------|
| 305 05 52 708 | 5 | 169 | 80 | 31,1/2 |



Samovar riscaldato

Heated Samovar
Samovar chauffé
Samovar calentado
Samovar aufgewärmt

| | Lt | Oz |
|---------------|-------|----------|
| 305 05 52 707 | 5 + 1 | 169 + 35 |

Teiera in vetro / Glass teapot

| | | |
|---------------|---|----|
| 305 08 02 580 | 1 | 35 |
|---------------|---|----|



1 Regolatore di temperatura (dai 45°C ai 95°C)
 Temperature regulator (from 45°C to 95°C)

2 Tasto ON - OFF
 ON-OFF button

3 Spie luminose/Spie luminose:

- temperatura resistenza >80°C
 temperature of the resistance is > di 80°
- il livello del liquido è sotto al minimo
 level of liquid is below minimum
- lampeggiante - il liquido è in fase di riscaldamento
 flashing: the liquid heating up
- fisso - il liquido ha raggiunto la temperatura desiderata
 fixed: it has reached the temperature set on the control knob

Distributore Aqva con base in marmo di Carrara

Aqva dispenser with Carrara marble stand

Distributeur Aqva avec support en Carrara marbre

Dispensador Aqva con soporte en Carrara mármol

Getränkspender Aqva mit Ständer aus Carrara Marmor

Marmo di Carrara e vetro - Carrara Marble and glass

| | h. Cm | h. In |
|---------------|-------|-------|
| 305 54 52 729 | 63 | 24.8 |

Il nostro **AQVA** è innovativo, per il suo design elegante ed originale e perché permette, grazie alla doppia parete, di avere una lentissima dispersione della temperatura del liquido interno.

Our **AQVA** is innovative for having an elegant and original design and because it allows, thanks to the double wall, to have an extremely low temperature dispersion of the inside liquid.



FREDDO

Mantenimento della temperatura delle bevande per 5/6 ore senza bisogno di fonti refrigeranti. Test effettuati ad una temperatura ambiente di 20°C (68°F)

COLD

Maintenance of drinks temperature for 5/6 hours without cooling element. Test carried out at 20°C (68°F) room temperature.

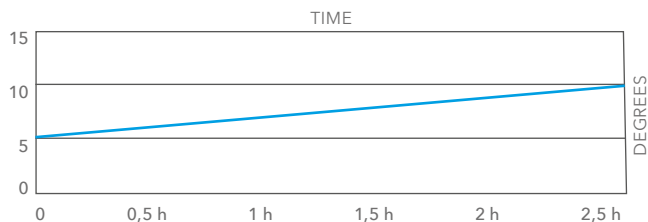

CALDO

Mantenimento della temperatura della bevanda per 4/5 ore senza bisogno di fonti di calore

HOT

Maintenance of drinks temperature for 4/5 hours without heating element.

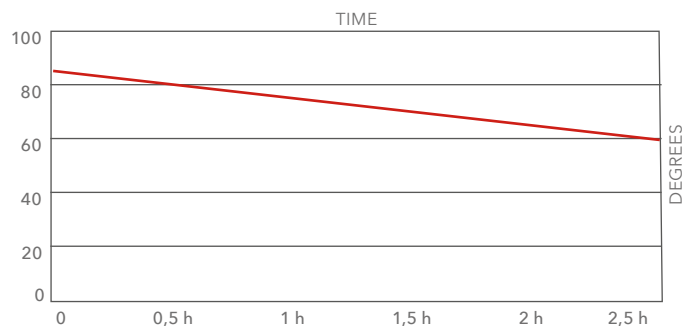

Distributore Aqva con alzata Classica

Aqva dispenser with Classica stand
 Distributeur Aqva avec support Classica
 Dispensador Aqva con soporte Classica
 Aqua Getränkespender mit Ständer Classica

| | ø Cm | H cm | ø In | H in |
|-----------------|------|------|--------|--------|
| 305 55 52 712 | 27 | 80 | 10,5/8 | 31,1/2 |
| cromato/chromed | | | | |

| | | | | |
|---|----|----|--------|--------|
| 305 07 52 712 | 27 | 80 | 10,5/8 | 31,1/2 |
| acciaio argentato/electro-plated stainless steel (EPSS) | | | | |



Distributore bevande caldo/freddo

Hot and cold beverage dispenser
 Distributeur de boissons chaud/froid
 Dispensador de bebidas caliente/frío
 Getränkespender warm/kalt

| | Lt | Oz | H. Cm. | H. In. |
|---------------|----|-----|--------|--------|
| 305 05 52 709 | 5 | 169 | 80 | 31,1/2 |



Distributore Aqva con alzata Nature

Aqva dispenser with Nature stand
 Distributeur Aqva avec support Nature
 Dispensador Aqva con soporte Nature
 Aqua Getränkespender mit Ständer Nature

| | Cm | H cm | In | H in |
|---------------|-------|------|---------------|--------|
| 305 44 52 711 | 26x26 | 38 | 10,1/4x10,1/4 | 31,1/2 |
| nero/black | | | | |

| | | | | |
|-----------------|-------|----|---------------|--------|
| 305 05 52 711 | 26x26 | 38 | 10,1/4x10,1/4 | 31,1/2 |
| cromato/chromed | | | | |



Distributore Aqva con base in noce

Aqva dispenser with walnut wood stand
 Distributeur Aqva avec support en bois de noyer
 Dispensador Aqva con soporte en madera de nogal
 Getränkespender Aqva mit Ständer aus Walnussholz

| | h. Cm | h. In |
|---------------|-------|-------|
| 305 54 52 728 | 63 | 24.8 |



Gennaro



Espositore piccola pasticceria

Petits fours display
 Présentoir à petits fours
 Soporte para pasteles
 Ständer für kleine Gebäcke



| | ø mm | H mm | ø In | H In | Fori/holes |
|---------------|------|------|--------|--------|------------|
| 607 N0 71 933 | 490 | 423 | 19,1/4 | 16,1/2 | 60 |
| 607 P0 68 115 | 340 | 300 | 13,3/8 | 11,3/4 | 32 |
| 607 P0 68 117 | 165 | 145 | 6,1/2 | 6,1/2 | 9 |

Paletta pasticceria Acciaio Inox

Server for petit fours small St.Steel
 Petite pelle à petits fours Acier Inox
 Pala pequeña para pastelitos Acero Inox
 Gebäckzange, Edelstahl

| | Cm | In. |
|----------------------|-------|-------------|
| 3050581708 | 5 | 2 |
| 3050581711 con piega | 3,7x9 | 1,5/8x3,1/2 |





Zeta Buffet



Distributore caffè

Coffee urn
Distributeur de café
Dispensador de café
Kaffespender

| | Lt | Cm | H Cm |
|---|----|---------|------|
| 305 05 52 631 <input checked="" type="checkbox"/> | 7 | 25 x 35 | 54 |
| 305 45 52 631 <input type="checkbox"/> | | | |
| 305 05 52 632 <input checked="" type="checkbox"/> | 10 | 25 x 35 | 62 |
| 305 45 52 632 <input type="checkbox"/> | | | |



Distributore succhi refrigerato

Thermal juice dispenser
Distributeur de jus réfrigéré
Dispensador de zumo refrigerado
Thermo-Saftspender

| | Lt | Cm | H Cm |
|---|-----|---------|------|
| 305 05 52 633 <input checked="" type="checkbox"/> | 7 | 25 x 35 | 53 |
| 305 45 52 633 <input type="checkbox"/> | | | |
| 305 05 52 644 <input checked="" type="checkbox"/> | 3,5 | 18 x 30 | 48 |
| 305 45 52 644 <input type="checkbox"/> | | | |



Distributore cereali

Cereal dispenser
 Distributeur céréales
 Dispensador cereales
 Cerealienspender 1-fach

| | Kg | Cm | H Cm |
|---|-----|---------|------|
| 305 05 52 636 <input checked="" type="checkbox"/> | 1,5 | 15 x 24 | 58 |
| 305 45 52 636 <input type="checkbox"/> | | | |

**Distributore cereali 2 comparti**

Double cereal dispenser
 Distributeur céréales double
 Dispensador cereales doble
 Cerealienspender 2-Fach

| | Kg | Cm | H Cm |
|---|---------|---------|------|
| 305 05 52 635 <input checked="" type="checkbox"/> | 2 x 1,5 | 25 x 32 | 58 |
| 305 45 52 635 <input type="checkbox"/> | | | |





Rinfrescacaraffe 2 comparti

Double thermal pitcher
Rafraîchisseur à 2 carafes
Enfriador para 2 jarras
Thermo-Karaffenhalter 2 Stck.

| | Cm | H. Cm | Lt |
|-----------------|---------|-------|-----|
| 305 05 52 634 ■ | 42 x 24 | 22 | 1,5 |
| 305 45 52 634 □ | | | |

**Rinfrescabottiglie termico 3 posti**

3-bottle cooler
Rafraîchisseur à 3 bouteilles
Enfriador para 3 botellas
Flaschenkühler 3-Fach

| | Cm | H. Cm |
|-----------------|---------|-------|
| 305 05 52 646 ■ | 42 x 24 | 23,5 |
| 305 45 52 646 □ | | |

**Rinfrescacaraffe 4 comparti acciaio inox**

Thermal pitcher 4-pc set
Rafraîchisseur à 4 carafes
Enfriador para 4 jarras
Thermo-Karaffehalter 4 Stck.

| | H. Cm | H. In |
|-----------------|-------|-------|
| 305 05 24 586 ■ | 63 | 24,8 |
| 305 45 24 586 □ | | |

* caraffe incluse / included pitcher



Set 2 coppe yogurt refrigerate

Thermal yogurt set, 2-bowl
Set 2 bols yaourt réfrigérés
Set 2 boles yogur refrigerados
Thermo-Schalen 2 Stck.

305 05 52 640 ■

305 45 52 640 □

Cm 42 x 24 x H. 13,5

ø 15 Cm

Lt 0,5



Set 2 coppe macedonia refrigerate

Thermal fruit-salad set, 2-bowl
Set 2 bols salade de fruits réfrigérés
Set 2 boles macedonia de frutas refrigerados
Thermo-Fruchtsalatschale 2 Stck. schwarz

305 05 52 637 ■

305 45 52 637 □

Cm 55 x 34,5 x H 16

ø 23 Cm

Lt 1,8



Coppa macedonia refrigerata

Thermal fruit salad bowl
Rafraîchisseur salade de fruits
Bol macedonia de frutas refrigerado
Thermo-Fruchtsalatschale

305 05 52 641 ■

305 45 52 641 □

Cm 30 x 30 x H 16

ø 23 Cm

Lt 1,8





Supporto alto per 3 coppette

3-bowl podium, tall
Support haut à 3 coupelles
Soporte alto para 3 boles
Buffetständer 3 Bowlst

| | Cm | H. Cm | ø Cm | Lt. |
|---|-----------|-------|------|------|
| 305 05 54 580 <input checked="" type="checkbox"/> | 42,5 x 15 | 19 | 12 | 0,25 |
| 305 45 54 580 <input type="checkbox"/> | | | | |

Supporto basso per 3 coppette

Podium 3-bowl, short
Support bas à 3 coupelles
Soporte bajo para 3 boles
Buffetständer 3 Bowlst

| | Cm | H. Cm | ø Cm | Lt. |
|---|-----------|-------|------|------|
| 305 05 54 579 <input checked="" type="checkbox"/> | 42,5 x 15 | 11,5 | 12 | 0,25 |
| 305 45 54 579 <input type="checkbox"/> | | | | |



Supporto alto per 2 coppe cereali con coperchio

2-bowl podium with lids, tall
Support haut à 2 coupes avec couvercles
Soporte alto para 2 boles con tapas
Buffetständer 2 Bowlst mit Deckel

| | Cm | H. Cm | ø Cm | Lt |
|---|---------|-------|------|-----|
| 305 05 54 607 <input checked="" type="checkbox"/> | 62 x 28 | 30 | 23 | 1,8 |
| 305 45 54 607 <input type="checkbox"/> | | | | |

Supporto basso per 2 coppe cereali con coperchio

2 bowl podium with lids, short
Support bas à 2 coupes avec couvercles
Soporte bajo para 2 boles con tapas
Buffetständer 2 Bowlst mit Deckel

| | Cm | H. Cm | Lt |
|---|---------|-------|-----|
| 305 05 54 606 <input checked="" type="checkbox"/> | 55 x 28 | 10 | 1,8 |
| 305 45 54 606 <input type="checkbox"/> | | | |





Vassoio formaggi ed affettati refrigerato

Thermal cheese/cold cuts tray
 Plateau à fromage/charcuterie réfrigéré
 Bandeja quesos/embutidos refrigerada
 Thermo-Aufschnittplatte

| | Cm | H. Cm |
|---|-----------|-------|
| 305 05 54 577 <input checked="" type="checkbox"/> | 55 x 34,5 | 20 |
| 305 45 54 577 <input type="checkbox"/> | | |



Vassoio refrigerato, eutetici a richiesta

Thermal tray, ice packs on demand
 Plateau réfrigéré, blocs réfrigérants sur demande
 Bandeja refrigerada, acumuladores de frío disponibles
 Thermo-Platte, Kühlelemente auf Anfrage

| | Cm | H. Cm |
|---|-----------|-------|
| 305 05 52 699 <input checked="" type="checkbox"/> | 55 x 34,5 | 4 |
| 305 45 52 699 <input type="checkbox"/> | | |



Vassoio yogurt Zeta refrigerato con ghiaccio

Zeta ice thermal yogurt tray
 Plateau à yaourts réfrigéré à glace Zeta
 Bandeja yogures refrigerable con hielo Zeta
 Joghurtablett Zeta, mit Eis kühlbar

| | Cm | H. Cm |
|---|-----------|-------|
| 305 05 52 638 <input checked="" type="checkbox"/> | 55 x 34,5 | 4 |
| 305 45 52 638 <input type="checkbox"/> | | |



Cestino pane acciaio inox

Bread basket with roll-top cover
 Corbeille à pain avec couvercle roll-top
 Cesta pan con tapa roll-top
 Brotkorb mit Rolltop

| | | |
|---|-----------|-------|
| | Cm | H. Cm |
| 305 05 52 650 <input checked="" type="checkbox"/> | 55 x 34,5 | 25 |
| 305 45 52 650 <input type="checkbox"/> | | |

**Cestino portapane con cloche**

Bread basket with roll-top cover
 Corbeille à pain avec couvercle roll-top
 Cesta pan con tapa roll-top
 Rattan Brotkorb mit Rolltop

| | | |
|---|-----------|-------|
| | Cm | H. Cm |
| 305 05 52 642 <input checked="" type="checkbox"/> | 55 x 34,5 | 30 |
| 305 45 52 642 <input type="checkbox"/> | | |

**Tagliere pane con base**

Bread cutting board with base
 Planche à pain avec plateau
 Tabla de cortar con base
 Brotschneidebrett

| | | |
|---|-----------|-------|
| | Cm | H. Cm |
| 305 05 54 578 <input checked="" type="checkbox"/> | 55 x 34,5 | 6 |
| 305 45 54 578 <input type="checkbox"/> | | |



Scaldabrioche

Croissant warmer
Chauffe-croissants
Calienta croissants
Croissantwärmer



| Cm | H. Cm |
|-----------|-------|
| 55 x 34,5 | 24,3 |

305 05 52 651

305 45 52 651



Alzata filo per basi GN 1/1

Wire stand for GN 1/1
Support en fil pour GN 1/1
Soporte en hilo para GN 1/1
Buffetständer mit GN 1/1 Einsatz

| Cm | H. Cm |
|-------------|-------|
| 57,5 x 35,8 | 27,6 |

305 05 42 597



Supporto con schermo igienico GN 1/1

Stand with hygienic shield
Ecran hygiénique
Pantalla higiénica
Buffetständer mit Hygieneplatte

| Cm |
|-----------|
| 59 x 34,4 |

305 12 53 609



Alzata torta con cloche

Cake stand with roll-top cover
 Présentoir à gâteaux avec couvercle roll-/top
 Presentación tarta con tapa roll-top
 Tortenplatte mit Rolltop

305 05 42 600
 305 45 42 600

| | ø Cm | Base Cm | H. Cm |
|-------------|------|---------|-------|
| piatto/dish | 38 | 18 x 18 | 37,2 |
| base/base | | | |

**Coppa punch**

Punch bowl
 Bol à punch
 Champañera
 Punch Bowl

| | ø Cm | Base Cm | H. Cm |
|---|------|---------|-------|
| 305 05 43 613 <input checked="" type="checkbox"/> | 40 | 18 x 18 | 33 |
| 305 45 43 613 <input type="checkbox"/> | | | |

**Vassoio multifunzione rettangolare**

Ectangular multipurpose tray
 Plateau multi-usage rectangulaire
 Bandeja multiuso rectangular
 Multifunktionstablett rechteckig

| | Cm | H. Cm |
|---|-----------|-------|
| 305 05 52 652 <input checked="" type="checkbox"/> | 55 x 34,5 | 4 |
| 305 45 52 652 <input type="checkbox"/> | | |

**Vassoio multifunzione quadrato**

Square multipurpose tray
 Plateau multi-usage carré
 Bandeja multiuso cuadrada
 Multifunktionstablett viereckig

| | Cm | H. Cm |
|---|---------|-------|
| 305 05 52 654 <input checked="" type="checkbox"/> | 30 x 30 | 4 |
| 305 45 52 654 <input type="checkbox"/> | | |





Manhattan Buffet



Manhattan

SET 1

Manhattan Tower
Tower Manhattan
Tower Manhattan
Manhattan Tower

305 05 52 A01 Cm
140 x 42

H Cm
65

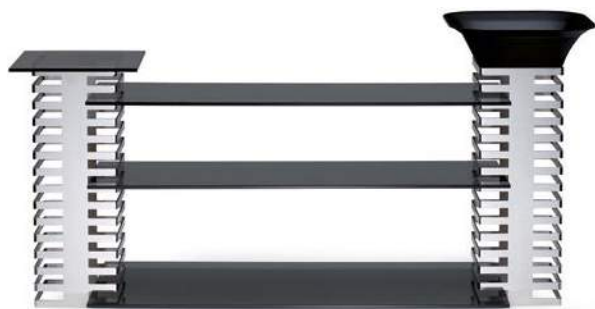

SET 2

Manhattan Tower
Tower Manhattan
Tower Manhattan
Manhattan Tower

305 05 52 A02 Cm
140 x 42

H Cm
50



SET 3

Manhattan Tower
Tower Manhattan
Tower Manhattan
Manhattan Tower

305 05 52 A03 Cm
150 x 145

H Cm
65



SET 4

Manhattan Tower
Tower Manhattan
Tower Manhattan
Manhattan Tower

305 05 52 A04 Cm
260 x 42



Tower

Tower

Tower

Tower

Tower

| | Cm | H. Cm |
|---------------|---------|-------|
| 305 05 42 604 | 20 x 20 | 10 |
| 305 05 42 605 | 20 x 20 | 22 |
| 305 05 42 606 | 20 x 20 | 34 |
| 305 05 42 607 | 20 x 20 | 58 |



Modulo a croce

Cross-shaped extension unit

Croix

Módulo con forma de cruz

Verbindungskreuz

| | H. Cm |
|---------------|-------|
| 305 05 42 608 | 9,5 |

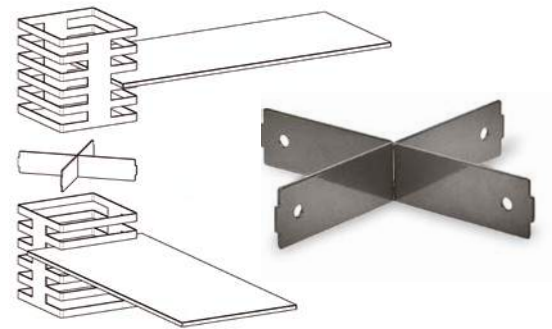

Scala angolare 4 ripiani

4-shelf corner ladder

Etagère angulaire 4 étages

Escalera angular 4 estantes

Eck-Leiter (4 Stufen) Plexiglas

V87 12 42 SA2



Coppa quadrata in plexiglass fumé

Smoky plexiglass salad bowl, square

Bol plexiglass fumé carré

Ensaladera acrílica fumé cuadrada

Salatschale Plexiglas viereckig Smoky

| | Cm | H. Cm |
|---------------|---------|-------|
| V87 12 42 C01 | 34 x 34 | 11 |
| V87 12 42 C02 | 34 x 34 | 19 |



Piatto quadrato plexiglass fumé

Smoky plexiglass buffet plate, square

Plat plexiglass fumé carré

Plato acrílico fumé cuadrado

Buffetplatte Plexiglas viereckig Smoky

| | Cm |
|---------------|---------|
| V87 12 42 P01 | 30 x 30 |



Manhattan

Piano in vetro fumé

Smoky glass top

Dessus en verre fumé

Tablero de cristal fumé

Glasplatte Smoky

| | Cm |
|---------------|----------|
| V87 08 42 Q01 | 30 x 30 |
| V87 08 42 Q02 | 42 x 42 |
| V87 08 42 R01 | 30 x 70 |
| V87 08 42 R02 | 30 x 100 |
| V87 08 42 R03 | 42 x 70 |
| V87 08 42 R04 | 42 x 100 |



Piano in ardesia

Slate top

Dessus en ardoise

Tablero de pizarra

Schieferplatte

| | Cm |
|---------------|----------|
| V87 09 42 Q01 | 30 x 30 |
| V87 09 42 Q02 | 42 x 42 |
| V87 09 42 R01 | 30 x 70 |
| V87 09 42 R02 | 30 x 100 |
| V87 09 42 R03 | 42 x 70 |
| V87 09 42 R04 | 42 x 100 |



Piano in mdf

Mdf top

Dessus en mdf

Tablero de mdf

Mdf Platte

| | Cm |
|---------------|----------|
| V87 04 42 Q01 | 30 x 30 |
| V87 04 42 Q02 | 42 x 42 |
| V87 04 42 R01 | 30 x 70 |
| V87 04 42 R02 | 30 x 100 |
| V87 04 42 R03 | 42 x 70 |
| V87 04 42 R04 | 42 x 100 |



Totem

Totem

Totem

Totem

Totem

| | Cm | H. Cm |
|---------------|-------------|-------|
| 305 05 42 609 | 24 x 24 | 14 |
| 305 05 42 610 | 24 x 24 | 22 |
| 305 05 42 611 | 32,5 x 32,5 | 14 |
| 305 05 42 612 | 32,5 x 32,5 | 22 |





Manhattan

Caratteristiche tecniche

- A** Asportabilità del coperchio a 90° con estrema facilità.
- B** Coperchio leggero e facilmente maneggiabile.
- C** Blocco automatico dell'estrazione del coperchio in fase di lavoro (da 0° a 89°).
- D** Chiusura e apertura frenata del coperchio. Sistema di cerniere brevettate Abert
- E** Superati i 70° il coperchio si apre completamente lasciandolo andare.
- F** La cerniera è un meccanismo a molla, inalterabile nel tempo, non necessita di regolazione e di manutenzione in quanto non ha frizione.
- G** Tutti i meccanismi sono costruiti in pregiati materiali inossidabili, quindi resistenti alla corrosione, agli ambienti umidi e adatti al contatto con gli alimenti.
- H** Lo scaldavivande è progettato per raccogliere la condensa in modo da lasciare il piano di appoggio completamente asciutto.
- I** Può essere utilizzato sia con riscaldamento elettrico sia con fornelli a combustibile solido.

Technical characteristics

- A** Easily removable cover, at 90°.
- B** Light and easy-to-handle cover.
- C** Automatic block of cover pull out when in operation (from 0° to 89°).
- D** Closing and opening slowed by cover. Abert patented system.
- E** Over 70° the cover opens fully when released.
- F** The hinge is a spring mechanism, inalterable in time, it does not need regulation and maintenance as it has no clutch.
- G** All the machineries are built in refined stainless materials, thus resistant to corrosion, humid environment and suitable for food contact.
- H** The chafing dish is designed to collect condensation, in order to keep the support base completely dry.
- I** Both electric warming and solid-fuelburners can be used.



Piastra elettrica Gn 2/3

Electric plate for ø Cm 30-40 round chafing dish
Élément électrique pour chafing-dish rond ø Cm 30-40
Elemento eléctrica para chafing dish redondo ø Cm 30-40
Elektroelement für runden Chafing Dish ø Cm 30-40

305 05 52 546

305 05 52 611 con regolatore - with regulator



Piastra elettrica Gn 1/1

Electric hot plate
Plaque électrique
Placa eléctrica
Elektrische Platte

305 05 52 547

305 05 52 610 con regolatore - with regulator



Fornelletto per scaldavivande

Chafing-dish burner
Porte brûleur pour chafing dish
Contenedor de combustible para chafing dish
Brennstoffhalter für Chafing Dish

305 05 52 536



Combustibile per scaldavivande

Solid fuel for chafing dish burner
Combustible pour chafing dish
Combustible para chafing dish
Brennstoff für Chafing Dish

305 05 72 519



Scaldavivande con gambe e coperchio in acciaio inox

Chafing dish with St. Steel stand and cover
Chafing dish avec support et couvercle en acier inox
Chafing dish con soporte y tapa en acero inox
Chafing Dish mit Beinen und Edelstahldeckel

| | Cm | H Cm |
|---------------|---------|------|
| GN 1/1 | | |
| 305 05 52 670 | 63 x 42 | 31 |
| GN 2/3 | | |
| 305 05 52 675 | 46 x 42 | 32 |

Completo di due fornelli a combustibile solido e predisposto per piastra elettrica.
 Portavivande GN 1/1 in acciaio incluso

With 1/1 Gastronorm food pan and two solid fuel burners.
Electric heating element available.



Scaldavivande con gambe e coperchio acciaio inox/vetro

Chafing dish with St. Steel/glass stand and cover
Chafing dish avec support et couvercle en acier inox / verre
Chafing dish con soporte y tapa en acero inox / vidrio
Chafing Dish mit Beinen und Edelstahl / Glass deckel

| | Cm | H Cm |
|---------------|---------|------|
| GN 1/1 | | |
| 305 05 52 679 | 63 x 43 | 33 |
| GN 2/3 | | |
| 305 05 52 683 | 46 x 42 | 32 |

Completo di due fornelli a combustibile solido e predisposto per piastra elettrica.
 Portavivande GN 1/1 in acciaio incluso

With 1/1 Gastronorm food pan and two solid fuel burners.
Electric heating element available.



Scaldavivande da incasso con coperchio in acciaio inox / vetro

Built-in chafing dish with St. Steel / glass cover
Chafing dish encastrable avec couvercle en acier inox / verre
Chafing dish para empotrar con tapa en acero inox / vidrio
Chafing Dish zum Einbauen mit Edelstahl / Glass Deckel

| | Cm | H Cm |
|---------------|-----------|------|
| GN 1/1 | | |
| 305 05 52 692 | 60,5 x 40 | 39,5 |
| GN 2/3 | | |
| 305 05 52 694 | 43 x 40 | 21 |

Refrigerato / Thermal

| | | |
|---------------|-----------|------|
| GN 1/1 | | |
| 305 05 52 705 | 60,5 x 40 | 39,5 |

Scaldavivande da incasso con coperchio in acciaio inox

Built-in chafing dish with St. Steel cover
Chafing dish encastrable avec couvercle en acier inox
Chafing dish para empotrar con tapa en acero inox
Chafing Dish zum Einbauen mit Edelstahl Deckel

| | Cm | H Cm |
|---------------|-------------|------|
| GN 1/1 | | |
| 305 05 52 693 | 60,5 x 40,5 | 39,5 |
| GN 2/3 | | |
| 305 05 52 695 | 43 x 40 | 21 |

Refrigerato / Thermal

| | | |
|---------------|-------------|------|
| GN 1/1 | | |
| 305 05 52 706 | 60,5 x 40,5 | 39,5 |

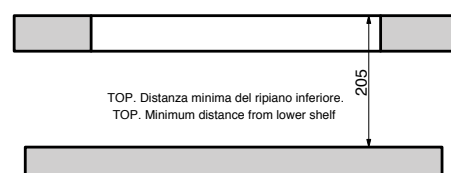
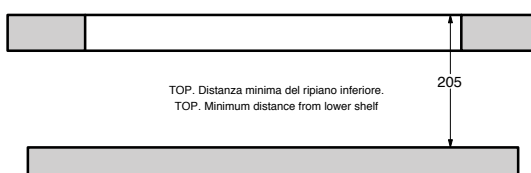
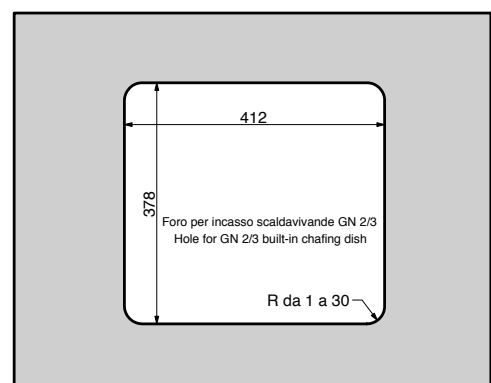
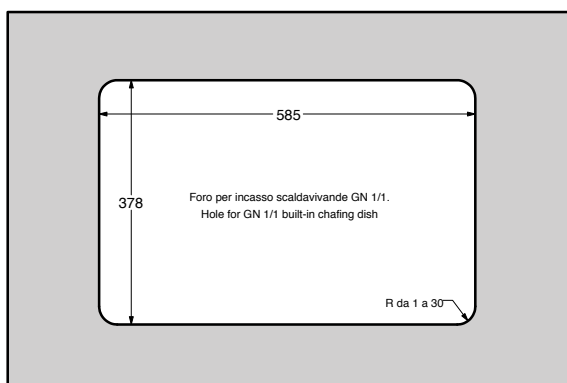



Scaldavivande a incastro GN 1/1

GN 1/1 built-in chafing dish
 Chafing dish encastrable GN 1/1
 Chafing dish empotrable GN 1/1
 Eingebautes Chafing Dish GN 1/1

305 05 52 665

Con coperchio in acciaio inox
 With Stainless steel cover

305 05 52 678

Con coperchio in vetro
 With glass cover

Completo di due fornelli a combustibile solido e predisposto per piastra elettrica.
 Portavivande GN 1/1 in acciaio incluso
 Supporti Manhattan esclusi

*With 1/1 Gastronorm food pan and two solid fuel burners.
 Electric heating element available.
 Manhattan stand excluded*



Set refrigerato a incastro GN 1/1

GN 1/1 built-in thermal set
 Set réfrigéré encastrable GN 1/1
 Set refrigerado empotrable GN 1/1
 Eingebautes Thermo-Einsatz GN 1/1

305 05 52 698

Con coperchio in vetro
 With glass cover

Set refrigerato GN 1/1 H.7,2 Cm completo di bacinella in acciaio inox, griglia in acciaio inox, eutettici, vassoio GN 1/1 H.Cm 2 in acciaio inox.
 Supporti Manhattan esclusi

*Thermal set GN 1/1 H. 7,2 Cm with St. Steel pan, St. Steel grid, ice packs,
 St. Steel tray GN 1/1 H. Cm 2.
 Manhattan stand excluded*

Manhattan

Coperchio GN 1/1 in acciaio inox

GN 1/1 stainless steel cover
Couvercle en acier inox GN 1/1
Tapa de acero inox GN 1/1
Edelstahldeckel GN 1/1

G03 05 52 665 H 7,2 Cm

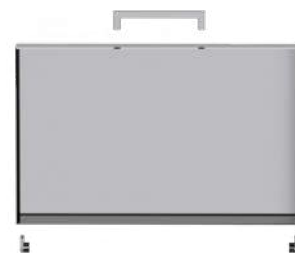

Coperchio GN 1/1 in vetro

GN 1/1 glass cover
Couverche en verre GN 1/1
Tapa de vidrio GN 1/1
Glasdeckel GN 1/1

G03 05 52 670 H 7,2 Cm



Griglia

Grid
Grille
Reja
Gittereinsatz

B4 705 52 668 H 2 Cm



Eutettico

Ice pack
Bloc réfrigérant
Acumulador de frío
Kühlakku

V77 12 95 G00



Portavivande GN 1/1 acciaio inox

Food pan
Bac
Cubeta
Einsatz

305 05 72 511 H 6,5 Cm - acciaio Inox



Bacinella GN 1/1 acciaio inox

Pan
Bassine
Cubeta
Einsatz tief

305 05 52 666

305 05 52 671



Supporto per set refrigerato

Stand for thermal set
Support pour set réfrigéré
Soporte para set refrigerado
Ständer für Thermo-Einsatz

G25 05 52 670



Inserto GN 1/1 in acciaio inox

Food pan, GN 1/1 18/10, stainless steel

V01 05 72 G11B

H. 6,5 Cm



Vassoio GN 1/1 in acciaio inox

Tray, Gn 1/1, stainless steel

V01 05 72 G11

H. 2 Cm



Inserto GN 2/3 in acciaio inox

Food pan, GN 2/3 18/10, stainless steel

V01 05 72 G23B

H. 6,5 Cm



Inserto GN 1/3 in acciaio inox

Food pan, GN 1/3 18/10, stainless steel

V01 05 72 G13B

H. 6,5 Cm



Inserto GN 1/2 in acciaio inox

Food pan, GN 1/2 18/10, stainless steel

V01 05 72 G12B

H. 6,5 Cm



Inserto GN 1/1 in porcellana

Food pan, GN 1/1, porcelain

305 21 52 557

H. 6,5 Cm



Inserto GN 1/1 in porcellana

Food pan, GN 1/1, porcelain

3052152672

H. 2 Cm



Inserto GN 2/3 in porcellana

Food pan, GN 2/3, porcelain

305 21 52 583

H. 6,5 Cm



Inserto GN 1/2 in porcellana

Food pan, GN 1/2, porcelain

305 21 52 581

H. 6,5 Cm



Inserto GN 1/3 in porcellana

Food pan, GN 1/3, porcelain

305 21 52 582

H. 6,5 Cm



Piatto piano quadrato in porcellana

Square flat plate, porcelain

263 33 42 649

22x22 Cm



Piatto fondo quadrato in porcellana

Square deep plate, porcelain

263 33 42 130

22x22 Cm





A still life composition featuring a silver buffet tray with fruit, a white bowl of pears, and books on a wooden table in front of a bookshelf. The tray holds several slices of watermelon, a cantaloupe, and a kiwi. To the left, a white bowl is filled with yellow pears. In the foreground, two books (one blue, one red) are stacked on the table. The background is a bookshelf with various books, including one with a red spine labeled 'MONDI PERLA'. The text 'Iseo - Classica Buffet' is overlaid in the center.

Iseo - Classica Buffet

COD. 305 07..... acciaio argentato - electro-plated stainless steel (EPSS)
 COD. 305 03..... acciaio argentato e ottone - electro-plated stainless steel (EPSS) and brass
 COD. 305 05..... acciaio e ottone - stainless steel and brass
 COD. 305 55..... acciaio inossidabile - stainless steel

Distributore caffè linea Iseo

Iseo coffee urn
Distributeur de café Iseo
Dispensador de café Iseo
Kaffeedispenser Iseo

| | Cm | Lt |
|---------------|--------------|----|
| 305 55 52 553 | 25 x 32 x 51 | 7 |
| 305 55 52 584 | 25 x 32 x 61 | 10 |

Con cloche rotante (180°) a scomparsa, fornito di portavivande 1/1
 Gastronorm e due bruciatori a combustibile solido.
 Predisposto per piastra elettrica.

*With revolving foldaway dome opening at 180°, 1/1 Gastronorm food
 pan and two solid fuel burners. Electric heating element available.*



Distributore succhi linea Iseo

Iseo juice dispenser
Distributeur de jus Iseo
Dispensador de zumo Iseo
Saftspender Iseo

| | Cm | Lt |
|---------------|--------------|----|
| 305 55 52 590 | 25 x 34 x 65 | 8 |

COD. 305 07..... acciaio argentato - electro-plated stainless steel (EPSS)
 COD. 305 03..... acciaio argentato e ottone - electro-plated stainless steel (EPSS) and brass
 COD. 305 05..... acciaio e ottone - stainless steel and brass
 COD. 305 55..... acciaio inossidabile - stainless steel



COD. 305 07..... acciaio argentato - electro-plated stainless steel (EPSS)
 COD. 305 03..... acciaio argentato e ottone - electro-plated stainless steel (EPSS) and brass
 COD. 305 05..... acciaio e ottone - stainless steel and brass
 COD. 305 55..... acciaio inossidabile - stainless steel

Scaldavivande rettangolare linea Iseo

Iseo rectangular chafing dish
 Chafing dish rectangulaire Iseo
 Chafing dish rectangular Iseo
 Chafing Dish Iseo, rechteckig

| | Cm | In. | Cm | H Cm |
|---------------|-----|-----|---------|------|
| 305 .. 52 615 | 1/1 | 1/1 | 68 x 51 | 45 |

Scaldacaffè a combustibile solido, predisposto per piastra elettrica

*Coffee urn solid fuel burner,
 electric heating element available as optional.*



Scaldavivande tondo linea Iseo

Iseo round chafing dish
 Chafing dish rond Iseo
 Chafing dish redondo Iseo
 Chafing Dish Iseo, rund

| | ø Cm | ø In. | Cm | H Cm |
|---------------|------|--------|---------|------|
| 305 .. 52 616 | 30 | 11,3/4 | 43 x 43 | 38 |
| 305 .. 52 617 | 40 | 15,3/4 | 52 x 52 | 46 |

Con cloche rotante (180°) a scomparsa, fornito di portavivande Gastro-
 norm e due bruciatori a combustibile solido.
 Predisposto per piastra elettrica.

*With revolving foldaway dome opening at 180°, Gastronorm food pan
 and two solid fuel burners. Electric heating element available.*



Caraffa vetro acqua frizzante con coperchio basculante

Sparkling water glass pitcher with smart lid
Carafe en verre à eau gazeuse avec couvercle basculant
Jarra de vidrio agua con gas con tapa basculante
Wasser Karaffe (Kohlen säüve) mit Kippen Kappe

| | Lt | Oz |
|---------------|----|----|
| 305 05 08 549 | 1 | 35 |



Caraffa vetro con coperchio basculante

Water glass pitcher with smart lid
Carafe en verre avec couvercle basculant
Jarra de vidrio con tapa basculante
Wasser Karaffe mit Kippen Kappe

| | Lt | Oz |
|---------------|----|----|
| 305 05 08 548 | 1 | 35 |



Caraffa succhi con coperchio

Juice pitcher with lid
Carafe à jus avec couvercle
Jarra zumo con tapa
Saftkrug mit Deckel

| | Lt | Oz |
|---------------|-----|----|
| 305 05 08 539 | 1,5 | 53 |



Caraffa succhi

Juice pitcher
Carafe à jus
Jarra zumo
Saftkrug
 (Argentata - silver plated)

| | Lt | Oz |
|---------------|-----|----|
| 310 07 08 546 | 2,0 | 70 |



Caraffa termica

Insulated beverage server
Pot isotherme
Jarra térmica
Termische Karaffe

| | Lt | Oz |
|---------------|------|----|
| 305 05 08 540 | 0,60 | 21 |
| 305 05 08 541 | 1,00 | 35 |
| 305 05 08 542 | 1,50 | 53 |



Caraffa termica conica

Insulated beverage server, conical
Pot isotherme conique
Jarra térmica cónica
Termische Karaffe, konisch

| | Lt | Oz |
|---------------|------|----|
| 305 05 08 557 | 0,30 | 10 |
| 305 05 08 558 | 0,60 | 21 |
| 305 05 08 559 | 1,00 | 35 |
| 305 05 08 560 | 1,50 | 53 |



Caraffa termica cilindrica

Thermal beverage server, cylindrical

*Pot isotherme cylindrique**Jarra térmica cilíndrica**Termische Karaffe, zylindrische*

Acciaio inossidabile - St. Steel

| | Lt | Oz |
|---------------|------|----|
| 305 05 08 540 | 0,60 | 21 |
| 305 05 08 541 | 1,00 | 35 |
| 305 05 08 542 | 1,50 | 53 |

| | |
|---------------|-------------------------------|
| 305 42 08 ... | coperchio black - black lid |
| 305 40 08 ... | coperchio copper - copper lid |
| 305 41 08 ... | coperchio gold - gold lid |

**Caraffa termica conica**

Thermal beverage server, conical

*Pot isotherme conique**Jarra térmica cónica**Thermische Karaffe, konisch*

Acciaio inossidabile - St. Steel

| | Lt | Oz |
|---------------|------|----|
| 305 05 08 557 | 0,30 | 10 |
| 305 05 08 558 | 0,60 | 21 |
| 305 05 08 559 | 1,00 | 35 |
| 305 05 08 560 | 1,50 | 53 |

| | |
|---------------|-------------------------------|
| 305 42 08 ... | coperchio black - black lid |
| 305 40 08 ... | coperchio copper - copper lid |
| 305 41 08 ... | coperchio gold - gold lid |



Portacereali girevole con 3 comparti

Rotating cereal stand, 3 - dish

Distributeur à céréales pivotant à 3 compartiments

Dispensador de cereales giratorio 3 sectores

Büffet-Ständer - drehbar mit drei Glasschalen

| | ø Cm | H. Cm | ø In. | H. In. |
|---------------|------|-------|--------|--------|
| V77 05 52 CV3 | 42 | 43 | 16,1/2 | 17 |

Con coppe in vetro - With glass bowls

| | ø Cm | H. Cm | ø In. | H. In. |
|---------------|------|-------|--------|--------|
| V77 05 52 CC3 | 42 | 43 | 16,1/2 | 17 |

Con coppe in vetro e coperchi in metacrilato

With glass bowls and acrylic lids



Portacereali girevole con 6 comparti

Rotating cereal stand 6 - dish

Distributeur à céréales pivotant à 6 compartiments

Dispensador de cereales giratorio 6 sectores

Büffet-Ständer - drehbar mit sechs Glasschalen

| | ø Cm | H. Cm | ø In. | H. In. |
|---------------|------|-------|--------|--------|
| V77 05 52 CV6 | 42 | 73 | 16,1/2 | 28,3/4 |

Con coppe in vetro - With glass bowls

| | ø Cm | H. Cm | ø In. | H. In. |
|---------------|------|-------|--------|--------|
| V77 05 52 CC6 | 42 | 73 | 16,1/2 | 28,3/4 |

Con coppe in vetro e coperchi in metacrilato

With glass bowls and acrylic lids



Distributore cereali girevole a 3 comparti con base in acciaio inossidabile

Rotating cereal dispenser with stainless steel base, triple
Distributeur à céréales pivotant à 3 compartiments avec base en acier inoxydable
Dipensador de cereales giratorio 3 sectores con base de acero inoxidable
3-Müesli-dispenser-drehbar, mit Edelstahlfuß

| | | | |
|---------------|--------|--------|----------|
| V77 05 52 CD6 | ø Cm | H. Cm | Lt |
| | 42 | 60 | 3 (x3) |
| | ø In. | H. In. | Oz |
| | 16,1/2 | 23,5/8 | 106 (x3) |



Distributore cereali con base in acciaio inossidabile

Cereal dispenser with stainless steel base
Distributeur céréales avec base en acier inoxydable
Dispensador de cereales con base de acero inoxidable
Müesli-dispenser mit Stahlbochen

| | | | |
|-------------------------------------|----------------|--------|----------|
| V77 05 52 CD4 - Singolo - Single | Cm | H. Cm | Lt |
| | 31 x 21 | 56 | 3 |
| | In. | H. In. | Oz |
| | 12,1/4 x 8,1/4 | 22 | 106 |
| V77 05 52 CD5 - 2 comparti - Double | Cm | H. Cm | Lt |
| | 37,5 x 24,5 | 57 | 3 (x2) |
| | In. | H. In. | Oz |
| | 14,3/4 x 9,5/8 | 22,1/2 | 106 (x2) |



Portaformaggi / affettati rettangolare non refrigerato - piano in polietilene

Rectangular cheese / cold cuts dish, non-thermal - Polyethylene board
 Plateau fromage / charcuterie rectangulaire non réfrigéré - Planche en polyéthylène
 Quesera rectangular no refrigerante - Tabla de polietileno
 Käse/Wurstwarenplatte - rechteckig, nicht gekühlt, Platte aus Acryl

| | Cm | In. |
|---------------|-----------|-----------------|
| V77 05 54 G11 | 53 x 32,5 | 20,7/8 x 12,3/4 |



Portaformaggi / affettati tondo non refrigerato - piano in polietilene

Round cheese / cold cuts dish, non-thermal - Polyethylene board
 Plateau fromage / charcuterie rond non réfrigéré - Planche en polyéthylène
 Quesera redonda no refrigerante - Tabla de polietileno
 Käse/Wurstwarenplatte - rund, nicht gekühlt, Platte aus Acryl

| | ø Cm | ø In. |
|---------------|------|--------|
| V77 05 54 T46 | 46 | 18,1/8 |



Portaformaggi / affettati rettangolare refrigerato - piano in polietilene

Rectangular cheese / cold cuts dish, thermal - Polyethylene board
 Plateau fromage / charcuterie rectangulaire réfrigérant - Planche en polyéthylène
 Quesera rectangular refrigerante - Tabla de polietileno
 Käse/Wurstwarenplatte - rechteckig, gekühlt, Platte aus Acryl

| | Cm | In. |
|-----------------|-----------|-----------------|
| V77 05 54 G11 R | 53 x 32,5 | 20,7/8 x 12,3/4 |



Portaformaggi / affettati tondo refrigerato - piano in polietilene

Round cheese / cold cuts dish, thermal - Polyethylene board
 Plateau fromage / charcuterie rond réfrigérant - Planche en polyéthylène
 Quesera redonda refrigerante - Tabla de polietileno
 Käse/Wurstwarenplatte - rund, gekühlt, Platte aus Acryl

| | ø Cm | ø In. |
|-----------------|------|--------|
| V77 05 54 T46 R | 46 | 18,1/8 |



Portaburro tondo

Butter cooler, round
 Beurrier rond
 Mantequera redonda
 Butterkühler, rund

| | ø Cm | H. Cm | ø In. | H. In. |
|---------------|------|-------|--------|--------|
| V77 05 09 T46 | 46 | 5 | 18,1/8 | 2 |
| V77 05 09 T32 | 32 | 6 | 12,5/8 | 2,3/8 |

**Portayogurt tondo**

Yogurt dish, round
 Plateau porte-yogourt rond
 Bandeja yogurt redonda
 Joghurtplatte, rund

| | ø Cm | H. Cm | ø In. | H. In. |
|---------------|------|-------|--------|--------|
| V77 05 52 T46 | 46 | 5 | 18,1/8 | 2 |

**Rinfresca yogurt / macedonia**

Yogurt / fruit salad cooler
 Rafraîchisseur à yogurt / salade de fruits
 Bol yogur / macedonia refrigerado
 Obstsalat / Joghurtschale, gekühlt

| | ø Cm | ø In. |
|---------------|------|--------|
| 305 05 43 601 | 28 | 11,1/8 |

310 12 15 790

Coperchio metacrilato - Acrylic lid

310 08 42 527

Coppa in vetro - Glass bowl

**Coperchio in metacrilato con pomolo in metallo per rinfresca yogurt/macedonia**

Acrylic lid with metal knob for fruit/salad cooler
 Couvercle acrylique avec pommeau en métal pour rafraîchisseur
 Tapa acrílica con pomo en metal para el macedonia/yogurt refrigerado
 Deckel aus Metakryl mit Metalknopf für joghurt/fruchtsalat kühltschale

| | ø Cm | ø In. |
|---------------|------|-------|
| 310 12 15 790 | 23 | 9 |



Portaprosciutto con base in marmo

Ham holder with marble base
 Porte-jambon avec base en marbre
 Jamonero con base de mármol
 Schinkenbasis aus Marmor

| | Cm | In. |
|---------------|--------------|--------------------|
| 305 05 91 657 | 22 x 58 x 18 | 8,5/8 x 22,7/8 x 7 |



Piatto salmone (argentato / legno)

Salmon cutting board (electro-plated stainless steel and wood)
 Planche à saumon (acier argenté et bois)
 Fuente salmón (acero plateado y madera)
 Lachsplatte, versilbert mit Holz

| | Cm | In. |
|---------------|---------|----------------|
| 305 07 22 656 | 87 x 19 | 34,1/4 x 7,1/2 |



Cestino portabrioches tondo

Croissant basket, round
 Corbeille ronde à viennoiseries
 Cesta de buffet redonda
 Büffetkorb, rund

| | ø Cm | ø In. |
|---------------|------|--------|
| V77 04 52 T44 | 44 | 17,3/8 |



Cestino portabrioches rettangolare

Croissant basket, rectangular
 Corbeille rectangulaire à viennoiseries
 Cesta de buffet rectangular
 Büffetkorb, rechteckig

| | Cm | In. |
|---------------|-----------|-----------------|
| V77 04 52 R50 | 50 x 29,5 | 19,3/4 x 11,5/8 |



Supporto refrigerato con caraffe succhi (4 pz.) Con alzata

Thermal stand with juice pitchers (4 - pc) with plate
Présentoir réfrigéré avec carafes à jus (4 - pcs) avec étagère
 Expositor refrigerante con jarras de zumo (4 pcs) con plato
 Saftkaraffenständer, gekühlt mit gläserständer

| | | |
|--|---------------------|----------------------|
| V77 05 52 SCA | H. Cm 70 | H. In. 27,1/2 |
| | ø 41,5 base | ø 16,3/8 base |
| | ø 38,5 alzata | ø 15,1/8 plate |
| | ø 16,4 Sede caraffa | ø 6,1/2 pitcher seat |
| | Lt | Oz |
| 400 04 79 300 Brocca acqua - Water pitcher | 1,5 | 53 |



Supporto refrigerato con caraffe succhi (4 pz.)

Thermal stand with juice pitchers (4 - pc)
Présentoir réfrigéré avec carafes à jus (4 - pcs)
 Expositor refrigerante con jarras de zumo (4 pcs)
 Saftkaraffenständer, gekühlt

| | | |
|--|---------------------|----------------------|
| V77 05 52 SCA 1 | H. Cm 36 | H. In. 14,1/8 |
| | ø 41,5 base | ø 16,3/8 base |
| | ø 16,4 Sede caraffa | ø 6,1/2 pitcher seat |
| 400 04 79 300 Brocca acqua - Water pitcher | 1,5 | 53 |



Vassoio sovrapponibile tondo gastrorm

Gastronorm round tray, stackable
Plateau empilable rond gastronorme
 Bandeja apilable redonda gastronorm
 Gastronorm Tablett, rund, stapelbar

| | | |
|-----------------|------|--------|
| | ø Cm | ø In. |
| V01 05 23 T46 S | 46 | 18,1/8 |
| V01 05 23 T54 S | 54 | 21,1/4 |



Vassoio sovrapponibile rettangolare gastrorm

Gastronorm rectangular tray, stackable
Plateau empilable rectangulaire gastronorme
 Bandeja apilable rectangular gastronorm
 Gastronorm Tablett, rechteckig, stapelbar

| | | |
|-----------------|-----------|-----------------|
| | Cm | In. |
| V01 05 23 G11 S | 53 x 32,5 | 20,7/8 x 12,3/4 |
| V01 05 23 G21 S | 65 x 53 | 25,5/8 x 20,7/8 |



Vassoio torta con bascula

Cake tray with rolltop cover
 Plateau à gateaux avec couvercle
 Bandeja tarta con tapa
 Orntablett mit speseglocke

| | ø Cm | ø In. |
|---------------|------|--------|
| 305 05 42 602 | 37 | 14,1/2 |



Alzata torta con bascula

Cake stand with rolltop cover
 Presentoir à gateaux avec couvercle
 Soporte tarta con tapa
 Tortenplatte

| | ø Cm | ø In. |
|---------------|------|--------|
| 305 05 42 601 | 37 | 14,1/2 |



Alzata torta

Cake stand
 Presentoir à gateaux
 Soporte pastel
 Tortenplatte

| | ø Cm | ø In. |
|---------------|------|--------|
| 305 05 42 516 | 22 | 8,5/8 |
| 305 05 42 517 | 32 | 12,5/8 |
| 305 05 42 518 | 42 | 16,1/2 |



Alzata frutta 3 piani

Fruit stand, 3 - tier
 Plat à fruits sur pied, 3 étages
 Frutero, 3 pisos
 Obstständer, 3 stufig

| | | |
|---------------|---------------------------------|-----------------|
| 305 05 42 523 | ø Cm 22 - 29 - 36,5 | H. Cm 50 |
| | ø In 8,5/8 - 11,1/2 - 14,3/8 | H. In 19,3/4 |

**Alzata torta nuziale**

Wedding cake stand
 Presentoir à gâteaux de mariage
 Soporte tarta nupcial
 Hochzeitstortenplatte

| | | |
|---------------|---------------------------------|-----------------|
| 305 05 42 519 | ø Cm 22 - 32 - 42 | H. Cm 54 |
| | ø In 8,5/8 - 12,5/8 - 16,1/2 | H. In 21,1/4 |



Classica

COD. 303 07..... acciaio argentato - electro-plated stainless steel (EPSS)
COD. 303 03..... acciaio argentato e ottone - electro-plated stainless steel (EPSS) and brass
COD. 303 05..... acciaio e ottone - stainless steel and brass
COD. 303 55..... acciaio inossidabile - stainless steel

Distributore caffè linea classica

Classica coffee urn

Distributeur de café Classica

Dispensador de café Classica

Kaffeedispenser Classica

| | Lt | Oz | Cm | H. Cm |
|----------------|----|-----|---------|-------|
| 303 ... 52 549 | 7 | 245 | 32 x 25 | 53 |
| 303 ... 52 550 | 10 | 350 | 24 x 32 | 52 |



Distributore succhi linea classica

Classica juice dispenser

Distributeur de jus Classica

Dispensador de zumo Classica

Saftspender Classica

| | Lt | Oz | Cm | H. Cm |
|----------------|----|-----|---------|-------|
| 303 ... 52 603 | 8 | 280 | 25 x 36 | 72 |



**Piastra elettrica
per distributore caffè**

**Electric heating
element for coffee urn**



**Piastra elettrica rettangolare
per scaldavivande gn 1/1**

**Electric heating element
for GN1/1 rectangular chafing dish**



COD. 303 07..... acciaio argentato - electro-plated stainless steel (EPSS)
 COD. 303 03..... acciaio argentato e ottone - electro-plated stainless steel (EPSS) and brass
 COD. 303 05..... acciaio e ottone - stainless steel and brass
 COD. 303 55..... acciaio inossidabile - stainless steel

Scaldavivande tondo linea Classica

Classica round chafing dish
 Chafing dish rond Classica
 Chafing dish redondo Classica
 Chafing Dish Classica, rund

| | ø Cm | ø In. |
|---------------|------|--------|
| 303 .. 52 613 | 30 | 11,3/4 |
| 303 .. 52 614 | 40 | 15,3/4 |

Con cloche rotante (180°) a scomparsa, fornito di portavivande Gastronorm e due bruciatori a combustibile solido. Predisposto per piastra elettrica.

*With revolving foldaway dome opening at 180°, Gastronorm food pan and two solid fuel burners.
 Electric heating element available.*



Scaldavivande rettangolare linea Classica

Classica rectangular chafing dish
 Chafing dish rectangulaire Classica
 Chafing dish rectangular Classica
 Chafing Dish Classica, rechteckig

| | GN | In. | Cm | H. Cm |
|---------------|-----|-----|---------|-------|
| 303 .. 52 612 | 1/1 | 1/1 | 67 x 43 | 45 |

Con cloche rotante (180°) a scomparsa, fornito di portavivande 1/1 Gastronorm e due bruciatori a combustibile solido. Predisposto per piastra elettrica.

*With revolving foldaway dome opening at 180°, 1/1 Gastronorm food pan and two solid fuel burners.
 Electric heating element available.*



Piastra elettrica per scaldavivande tondo ø Cm 30-40

Electric heating element for Ø cm 30-40 chafing dish



Fornelletto per scaldavivande

Chafing dish burner



Classica

COD. 303 07..... acciaio argentato - electro-plated stainless steel (EPSS)
COD. 303 03..... acciaio argentato e ottone - electro-plated stainless steel (EPSS) and brass
COD. 303 05..... acciaio e ottone - stainless steel and brass
COD. 303 55..... acciaio inossidabile - stainless steel

Alzata rettangolare linea Classica

Classica rectangular stand
Présentoir rectangulaire Classica
Soporte rectangular Classica
Rechteckiger Ständer, Classica

| | Cm | In. | H. Cm. | H. In. |
|---------------|---------|-----------|--------|--------|
| 303 .. 52 702 | 28 x 49 | 11x19,1/4 | 21 | 8,1/4 |

Vassoio refrigerato - Thermal tray

305 .. 54 611 GN 1/1



Alzata tonda linea Classica

Classica round stand
Présentoir rond Classica
Soporte redondo Classica
Runder Ständer, Classica

| | ø Cm | ø In. | H. Cm. | H. In. |
|---------------|------|-------|--------|--------|
| 303 .. 52 703 | 22 | 8,5/8 | 21 | 8,1/4 |

Ciotola in porcellana - porcelain bowl

264 02 53 170 28 11



COD. 305 07..... acciaio argentato - electro-plated stainless steel (EPSS)
 COD. 305 03..... acciaio argentato e ottone - electro-plated stainless steel (EPSS) and brass
 COD. 305 05..... acciaio e ottone - stainless steel and brass
 COD. 305 55..... acciaio inossidabile - stainless steel

Classica

Distributore Aqva con alzata Classica

Aqva dispenser with Classica stand
 Distributeur Aqva avec support Classica
 Dispensador Aqva con soporte Classica
 Aqua Getränkespender mit Ständer Classica

| | ø Cm | H cm | ø In | H in |
|---------------|------|------|--------|--------|
| 305 .. 52 712 | 27 | 80 | 10,5/8 | 31,1/2 |



Coppa punch con manici Rubans

Punch bowl with Rubans handles
 Bol à punch avec poignées Rubans
 Champañera con asas Rubans
 Punschschale mit Griff Rubans

| | ø Cm | Lt | ø In. | Oz |
|---------------|------|----|--------|-----|
| 310 00 43 602 | 50 | 20 | 19,3/4 | 700 |





Alzata frutta 2-3-4 piani

Fruit stand, 2-3-4-tier

Plat à fruits sur pied, 2-3-4 étages

Frutero, 2-3-4 pisos

Obstständler, 2-3-4 stufig

| | | ø Cm | H. Cm | ø In. | H. In. |
|---------------|--------------------|-------------|-------|----------------------------|---------|
| 310 00 42 564 | (2 piani / 2 tier) | 30/25 | 49 | 11,3/4-9,7/8 | 19,5/16 |
| 310 00 42 565 | (3 piani / 3 tier) | 40/30/25 | 69 | 15,3/4-11,3/4-9,7/8 | 27 |
| 310 00 42 577 | (3 piani / 3 tier) | 54/40/30 | 69 | 21,1/4-15,3/4-11,3/4 | 27 |
| 310 00 42 571 | (4 piani / 4 tier) | 54/40/30/25 | 90 | 21,1/4-15,3/4-11,3/4-9,7/8 | 35,3/8 |

Alzata frutta

Fruit stand
 Plat à fruits sur pied
 Frutero
 Obständer

| | ø Cm | ø In. |
|---------------|------|--------|
| 310 00 42 574 | 30 | 11,3/4 |
| 310 00 42 539 | 40 | 15,3/4 |
| 310 00 42 549 | 54 | 21,1/4 |

**Alzata frutta**

Fruit stand
 Plat à fruits sur pied
 Frutero
 Obständer

| | ø Cm | ø In. |
|---------------|------|--------|
| 310 00 42 535 | 30 | 11,3/4 |

**Alzata torta**

Cake stand
 Presentoir à gâteaux
 Soporte pastel
 Tortenplatte

| | ø Cm | ø In. |
|---------------|------|--------|
| 310 00 42 526 | 32 | 12,5/8 |



ChafingDishAccessories

Inserto GN 1/1 in acciaio inox

Food pan, GN 1/1 18/10, stainless steel

V01 05 72 G11B

H. 6,5 Cm



Vassoio GN 1/1 in acciaio inox

Tray, Gn 1/1, stainless steel

V01 05 72 G11B

H. 2 Cm



Inserto GN 2/3 in acciaio inox

Food pan, GN 2/3 18/10, stainless steel

V01 05 72 G23B

H. 6,5 Cm



Inserto GN 1/3 in acciaio inox

Food pan, GN 1/3 18/10, stainless steel

V01 05 72 G13B

H. 6,5 Cm



Inserto GN 1/2 in acciaio inox

Food pan, GN 1/2 18/10, stainless steel

V01 05 72 G12B

H. 6,5 Cm



Inserto GN 1/1 in porcellana

Food pan, GN 1/1, porcelain

305 21 52 557

H. 6,5 Cm



Inserto GN 1/1 in porcellana

Food pan, GN 1/1, porcelain

3052152672

H. 2 Cm



Inserto GN 2/3 in porcellana

Food pan, GN 2/3, porcelain

305 21 52 583

H. 6,5 Cm



Inserto GN 1/2 in porcellana

Food pan, GN 1/2, porcelain

305 21 52 581

H. 6,5 Cm



Inserto GN 1/3 in porcellana

Food pan, GN 1/3, porcelain

305 21 52 582

H. 6,5 Cm



Set minestre per scaldavivande rettangolare

Soup tureen set for rectangular chafing dish

Set de soupieres pour chafing dish rectangulaire

Set de soperas para chafing dish rectangular

Suppenchüsselset für Chafing Dish rechteckig

| | | Cm | In. |
|---------------|------------------------|-----|-----|
| 305 05 52 626 | Adattatore - Adapter | 1/1 | 1/1 |
| | | Lt | Oz |
| 305 05 15 796 | Zuppiera - Soup tureen | 4,2 | 142 |



Portavivande tondo in acciaio inossidabile

Round food pan, stainless steel

Bac rond en acier inoxydable

Cubeta redonda en acero inoxidable

Behälter rund, edelstahl rostfrei

| | ø Cm | ø In. |
|---------------|------|--------|
| 305 05 72 516 | 30 | 11,3/4 |
| 305 05 72 517 | 40 | 15,3/4 |



Portavivande tondo in porcellana

Round food pan, porcelain

Bac rond en porcelaine

Cubeta redonda en porcelana

Porzellanbehälter, rund

| | ø Cm | ø In. |
|---------------|------|--------|
| 305 21 72 756 | 30 | 11,3/4 |
| 305 21 52 559 | 40 | 15,3/4 |



Inserto scaldavivande tondo in porcellana

Food pan half round chafing dish, porcelain with divider

Bac double en porcelaine pour chafing dish rond

Cubeta en porcelana para chafing dish redondo

Porzellan einsatz, 2tlg für chafing dish rund

| | ø Cm | ø In. |
|-----------------------|------|--------|
| 305 21 71 951 (1 Pz.) | 40 | 15,3/4 |



Portauovo per scaldavivande tondo in porcellana

Egg holder for round chafing dish, porcelain

Porte-oeufs en porcelaine pour chafing dish rond

Porta huevos en porcelana para chafing dish redondo

Porzellanereinsatz für chafing dish rund

| | Cm | ø In. |
|---------------|----|--------|
| 305 21 71 950 | 40 | 15,3/4 |



Set zuppiere per scaldavivande tondo Cm 40

Soup tureen set for Cm 40 round chafing dish

Set de soupnières pour chafing dish rond Cm 40

Set de soperas para chafing dish redondo Cm 40

Suppenchüsselset für Chafing Dish rund ø Cm 40

| | ø Cm | ø In. |
|-------------------------------------|------|--------|
| 305 05 52 627 Adattatore - Adapter | 40 | 15,3/4 |
| | Lt | Oz |
| 305 05 15 796 Zuppiera - Souptureen | 4,2 | 142 |





A close-up, low-angle shot of a modern table's edge. The table features a dark, vertically-grained wood or wood-grain laminate top. A thin, dark metal trim strip runs along the edge of the top, creating a sharp, clean finish. The background is a soft, out-of-focus grey, emphasizing the texture and materials of the table.

Italo

Cottura - Cooking





Mantenimento del calore - Heat-keeping

Display





Piano in vitroceramica per mantenimento calore

Vitroc ceramic top, heat keeping

Plaque en vitrocéramique pour conserver la chaleur

Placa de vitrocerámica para el mantenimiento de calor

Ebene aus Glaskeramik fuer Wärmeerhaltung

| | Cm | In. |
|---------------|---------|---------------|
| 305 05 52 726 | 60x38,5 | 23,5/8x15,1/8 |

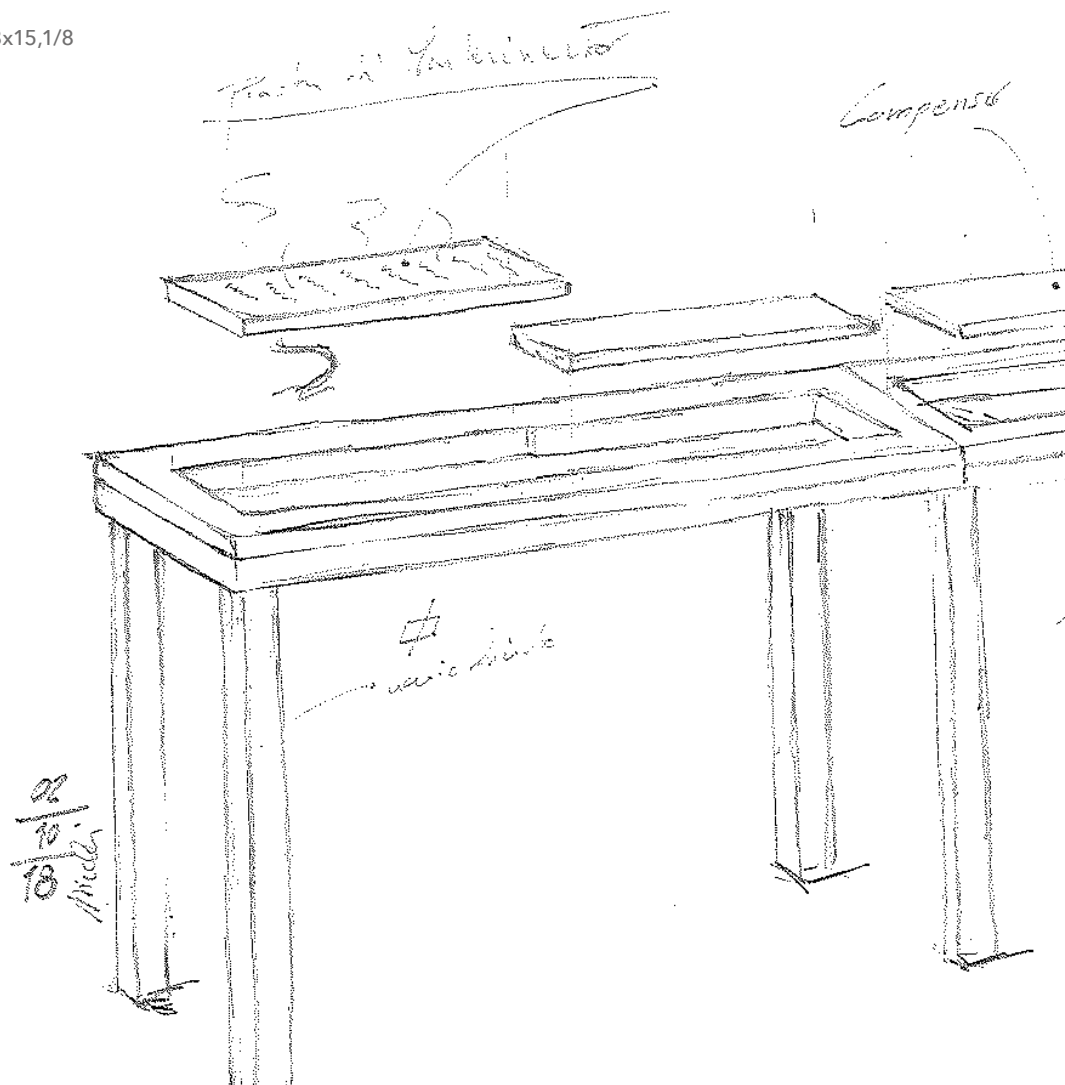



Piano a induzione con supporto in acciaio

Induction cooktop with steel countertop

Plaque à induction avec table de travail en acier

Placa de inducción con encimera en acero

Induktionskochplatte mit Arbeitsplatte Edelstahl

| | Cm | In. |
|---------------|---------|---------------|
| 305 05 52 725 | 30x38,5 | 23,5/8x15,1/8 |

Compenso in acciaio

Steel countertop

Table de travail en acier

Encimera en acero

Arbeitsplatte Edelstahl

| | Cm | In. |
|---------------|---------|---------------|
| 305 05 52 727 | 30x38,5 | 11,3/4x15,1/8 |

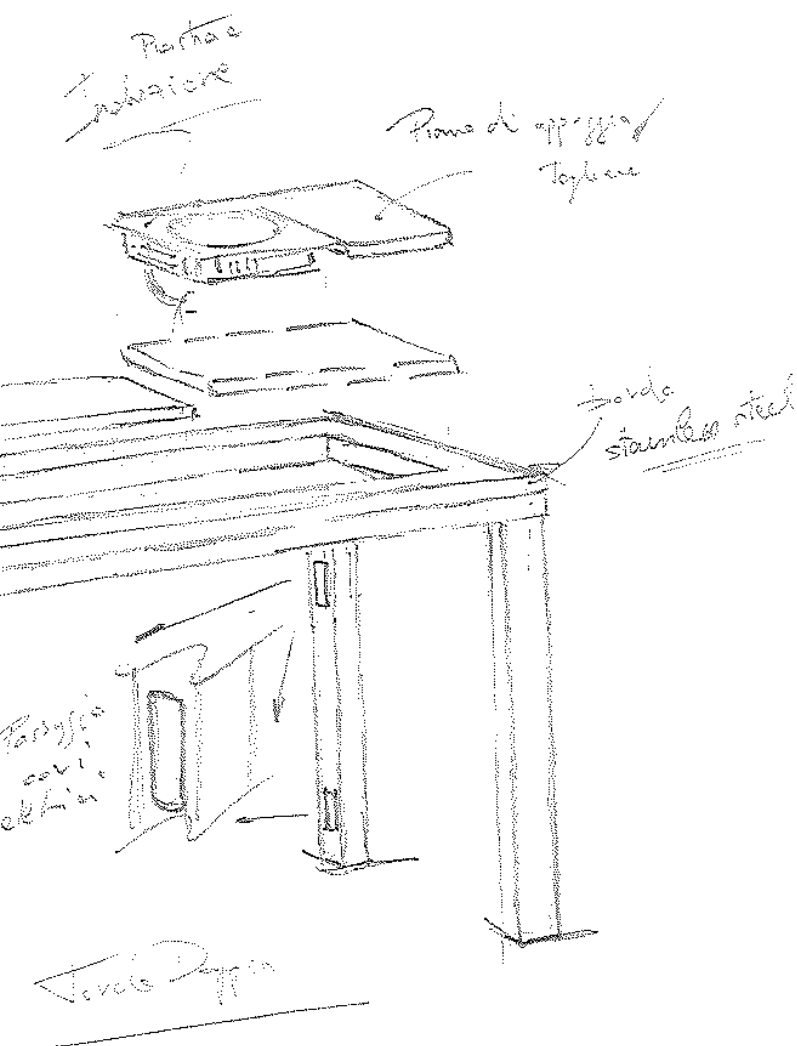

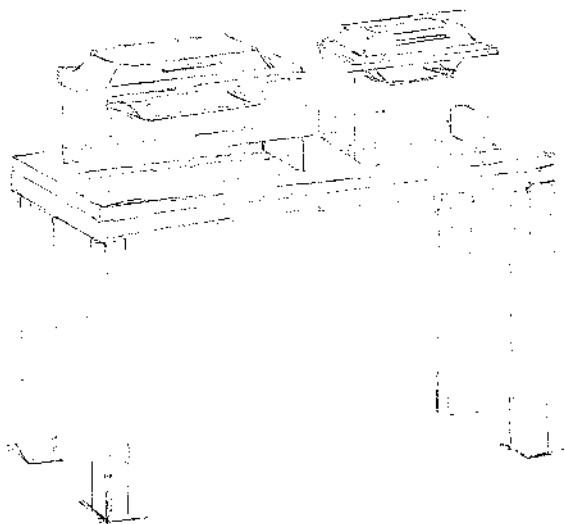

Scaldavivande da incasso con coperchio in acciaio inox

Built-in chafing dish with St. Steel cover
Chafing dish encastrable avec couvercle en acier inox
Chafing dish para empotrar con tapa en acero inox
Chafing Dish zum Einbauen mit Edelstahl Deckel

| | Cm | H Cm |
|---------------|-------------|------|
| GN 1/1 | | |
| 305 05 52 693 | 60,5 x 40,5 | 39,5 |

Refrigerato / Thermal

| | | |
|---------------|-------------|------|
| GN 1/1 | | |
| 305 05 52 706 | 60,5 x 40,5 | 39,5 |

Scaldavivande da incasso con coperchio in acciaio inox / vetro

Built-in chafing dish with St. Steel / glass cover
Chafing dish encastrable avec couvercle en acier inox / verre
Chafing dish para empotrar con tapa en acero inox / vidrio
Chafing Dish zum Einbauen mit Edelstahl / Glass Deckel

| | Cm | H Cm |
|---------------|-----------|------|
| GN 1/1 | | |
| 305 05 52 692 | 60,5 x 40 | 39,5 |

Refrigerato / Thermal

| | | |
|---------------|-----------|------|
| GN 1/1 | | |
| 305 05 52 705 | 60,5 x 40 | 39,5 |



**Scaldavivande da incasso
con coperchio in acciaio inox**

Built-in chafing dish with St. Steel cover
Chafing dish encastrable avec couvercle en acier inox
Chafing dish para empotrar con tapa en acero inox
Chafing Dish zum Einbauen mit Edelstahl Deckel

| | Cm | H Cm |
|---------------|---------|------|
| GN 2/3 | | |
| 305 05 52 695 | 43 x 40 | 21 |

**Scaldavivande da incasso
con coperchio in acciaio inox /vetro**

Built-in chafing dish with St. Steel / glass cover
Chafing dish encastrable avec couvercle en acier inox / verre
Chafing dish para empotrar con tapa en acero inox / vidrio
Chafing Dish zum Einbauen mit Edelstahl / Glass Deckel

| | Cm | H Cm |
|---------------|---------|------|
| GN 2/3 | | |
| 305 05 52 694 | 43 x 40 | 21 |

Compenso GN 1/3 in laminato

GN 1/3 countertop laminate
Table de travail GN 1/3 en melamine
Encimera GN 1/3 en laminado
Arbeitsplatte GN 1/3

| | Cm | In. |
|-----------------|-------------|----------------|
| ■ 305 04 51 709 | 17,6 x 32,5 | 6,7/8 x 12,3/4 |
| ■ 305 51 51 709 | 17,6 x 32,5 | 6,7/8 x 12,3/4 |





Caratterizzato da un design pulito

e funzionale che lo rende simile a un mobile contemporaneo, il carrello Italo può essere utilizzato come comodo sostegno e mezzo di trasporto per i tavoli opportunamente piegati.

It stands out with a simple design;

trolley Italo can be used as a useful support, as well as a carriage of the tables properly folded.

Il carrello è dotato di 3 scaffali

nei quali riporre i prodotti che successivamente verranno disposti sul tavolo. Una volta svuotato, può essere trasformato in un mobile nel quale collocare ordinatamente le stoviglie; può inoltre essere utilizzato come piano di appoggio aggiuntivo al tavolo. Composto da materiali pregiati: acciaio e legno. È inoltre dotato di 4 ruote in acciaio pivotanti e con freno.

Misure: 115 x 59 x H 89 Cm

The trolley contains accommodations and

sections where one can store the products which, after that, will be placed on the table. Once empty, taking off the dividers, it can be transformed in a piece of furniture in which it is possible to store tableware tidily; also, it can be used as an additional countertop besides the table. Made of high-quality materials: steel and wood.

Size: 115 x 59 x H 89 Cm





Carrello

Trolley
Chariot
Carro
Wagen

| | | |
|-----------------|----------------|----------------|
| | Cm | In. |
| ■ 305 51 52 647 | 115 x 59 H. 89 | 6,7/8 x 12,3/4 |

Carrello

Trolley
Chariot
Carro
Wagen

| | | |
|-----------------|----------------|----------------|
| | Cm | In. |
| ■ 305 04 52 647 | 115 x 59 H. 89 | 6,7/8 x 12,3/4 |



Tavolo 1

Table 1

Table 1

Mesa 1

Tisch 1

Cm
132 x 65

H Cm
89

In.
52 x 25,5

H. In
35

■ 305 04 51 651

■ 305 51 51 651



Tavolo 2

Table 2

Table 2

Mesa 2

Tisch 2

Cm
264 x 65

H Cm
89

In.
104 x 25,5

H. In
35

■ 305 04 51 652

■ 305 51 51 652



Tavolo 2+1

Table 2+1

Table 2+1

Mesa 2+1

Tisch 2+1

| | Cm | H Cm | In. | H. In |
|-----------------|----------|------|------------|--------|
| Chiuso - Closed | 132 x 65 | 103 | 52 x 25,5 | 40,1/2 |
| Aperto - Open | 396 x 65 | 89 | 145 x 25,5 | 35 |

■ 305 04 51 653

■ 305 51 51 653

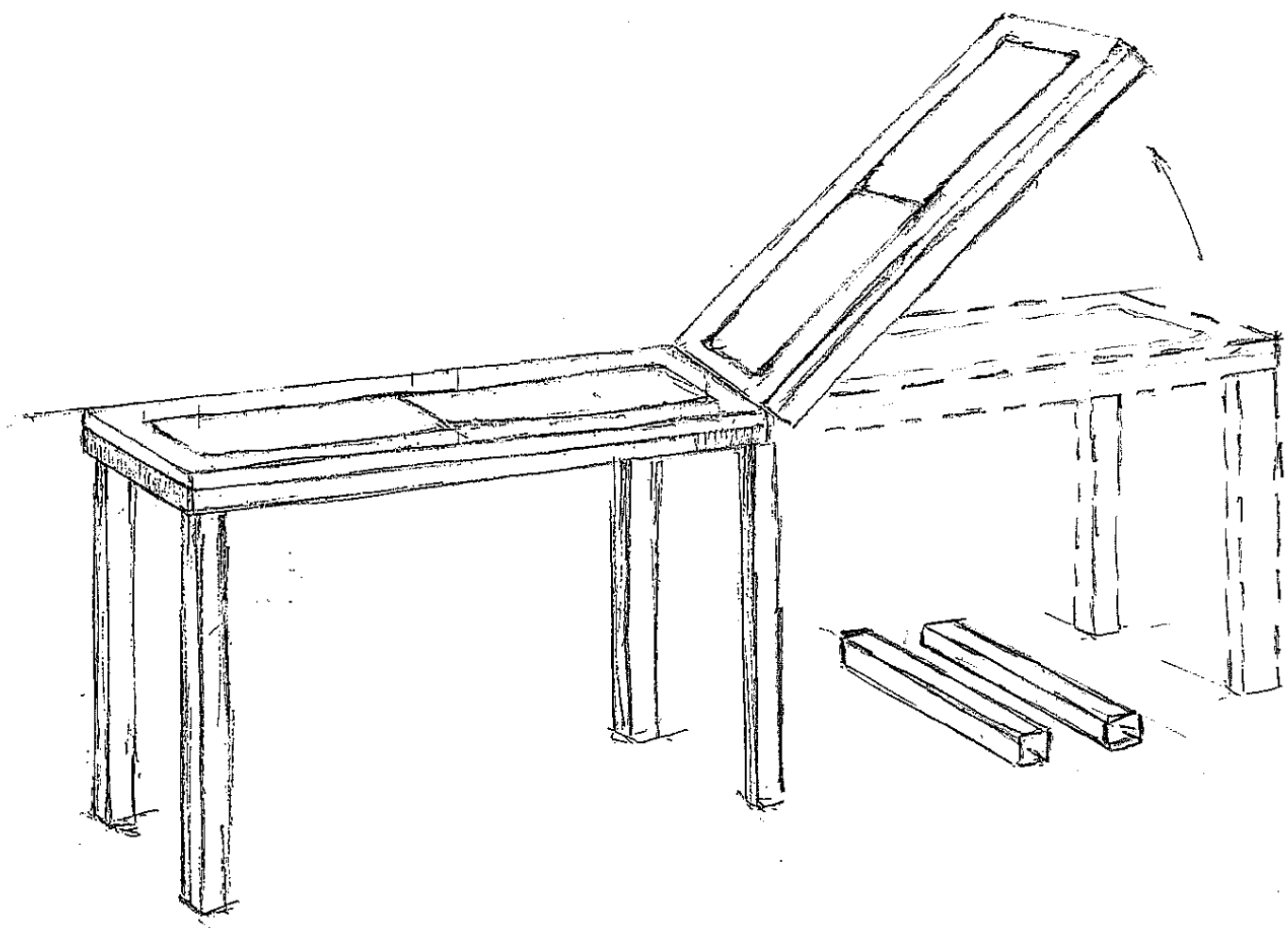

Ogni tavolo e' dotato di due compensi in legno removibili, ciascuno dei quali misura 60x38,5cm, in modo da poter allocare all'interno dei tavoli i seguenti accessori:

Cahafing dish gn 2/3 + compenso legno
Cahafing dish gn 1/1
Piano ad induzione
Piano per il mantenimento del calore

Each table has two removable wood countertops, whose size is 60x38,5 cm, so that inside the tables the following accessories can be fitted:

*GN 2/3 chafing dish+ wood countertop
GN 1/1 chafing dish
Induction cooktop
Top, heat-keeping*



Possibilita' di avere una o piu' gambe del tavolo adatte a nascondere i cavi elettrici. Tutte le gambe dei tavoli hanno un aggancio semplificato (attraverso due perni facilmente avvitabili senza alcun utensile).

Possibility of having one or more table legs, suitable for hiding the electric cables. All the table legs have a simple coupling (by two pivots, easily screwable by hand).

Gamba elettrificata su richiesta

Electric leg
Jambe électrique
Pata eléctrica
Elektrische Beine

B35 05 51 652



Carrelli
Trolleys

I nuovi carrelli PiGreco, con telaio in acciaio

inossidabile 18/10 e ripiani in legno verniciato opaco, regalano una vera e propria rivoluzione nel campo del servizio.

La presenza di sole due gambe diametralmente opposte permette una facilità di carico fino ad oggi mai sperimentata.

Le linee pulite, moderne ed eleganti, il design brevettato, lo stile accattivante e la cura nei minimi dettagli rendono PiGreco unico nel suo genere.

Disponibile nella versione nero opaco o, a richiesta, in legno chiaro naturale; i carrelli a 2 o 3 ripiani sono componibili e personalizzabili grazie alla vasta gamma di accessori.

The new PiGreco trolleys, with stainless steel structure and matte varnished wood tops, represent a real revolution in the service field.

Only two legs, diametrically opposite, allow easy loading, never experienced before. Clean lines, modern and elegant, patented design, appealing style and care of the smallest details, make PiGreco a one of a kind trolley.

It comes in matte black or, upon request, natural light wood; 2-tier and 3-tier trolleys are modular and customizable thanks to a wide accessories range.

Die neuen Wagen PiGreco, mit Edelstahl 18/10

Gestell und die Bretter aus matt lackiertem Holz, stellen eine echte Revolution im Service-Bereich dar.

Nur zwei Beine, diametral entgegengesetzt, erlauben eine leichte Beladung noch nie bis heute erlebt

Die saubere Linie, modern und elegant, das patentierte Design, ein gewinnendes Stil und eine Pflege in allen Einzelheiten machen PiGreco einzig in seiner Art

Lieferbar matt schwarz oder, auf Wunsch in natürlichem hellem Holz; die 2- und 3-stufige Wagen sind modular und personell gestaltet dank einer breiten Zubehörpalette

Les nouveaux chariots PiGreco, avec cadre en acier

inoxidable 18/10 et étagères en bois laqué opaque, représentent une véritable révolution dans le domaine du service. La présence de deux seuls supports, diamétralement opposés, permet une facilité de charge jamais expérimentée jusqu'aujourd'hui.

Les lignes essentielles, modernes et élégantes, le design breveté, le style charmant et le soigne dans les moindres détails rendent PiGreco unique en son genre.

Disponible dans la version noir opaque ou, sur la demande, en bois clair naturel; les chariots avec 2 ou 3 étagères sont modulables et personnalisables grâce à la vaste gamme des accessoires.

Los nuevos carros de servicio PiGreco, con estructura

en acero inoxidable 18/10 y estantes en madera barnizada opaca, representan una verdadera revolución en el campo del servicio.

La presencia de dos soportes solamente, diametralmente opuestos, permite una facilidad de carga nunca experimentada hasta ahora.

Las líneas limpias, modernas y elegantes, el diseño patentado, el estilo cautivador y el cuidado de los más mínimos detalles hacen PiGreco único en su género.

Disponible en la versión negro opaco o, a pedido, en madera clara natural; los carros de 2 o 3 niveles son modulares y personalizables gracias a la vasta gama de accesorios.



Pigreco

Modern and
stylish structures



Carrello servire 2 ripiani

Service trolley, 2-tier
 Chariot de service 2 étagères
 Carro servicio 2 niveles
 Servierwagen, 2-stufig

| | Cm | H. Cm | In. | H. In. |
|---------------|-------|-------|---------------|--------|
| 319 04 51 681 | 90x50 | 82 | 35,3/8x19,3/4 | 32,1/4 |



Carrello di servizio adeguato a qualsiasi utilizzo. Base a 2 ripiani alla quale si possono abbinare vari componenti per creare il carrello che meglio risponde alle vostre esigenze.

E' dotato di ruote antivibrazione, pivotanti, di cui 2 con freno, adatte ad ogni tipo di pavimentazione. L'aspetto estetico, dalle linee pulite allo stile accattivante, rendono PiGreco unico nel suo genere.

Service trolley suitable for every use. A 2-tier base to which you can combine various components to create the trolley that best meets your requirements.

It is equipped with anti-vibration, pivoting wheels, 2 of which with brake. The aesthetic appearance, with clean lines and appealing style make PiGreco a one of a kind trolley.



Poggiapiatto estraibile in legno
 Wood removable tray



Pratica maniglia in acciaio inossidabile
 Stainless steel handles



Ruota pivotante rivestita con gomma antistatica
 Pivoting wheel with anti-static rubber



Carrello servire 3 ripiani

Service trolley, 3-tier
 Chariot de service 3 étagères
 Carro servicio 3 niveles
 Servierwagen, 3-stufig

| | Cm | H. Cm | In. | H. In. |
|---------------|-------|-------|---------------|--------|
| 319 04 51 682 | 90x50 | 82 | 35,3/8x19,3/4 | 32,1/4 |



Carrello di servizio adeguato a qualsiasi utilizzo. Base a 3 ripiani alla quale si possono abbinare vari componenti per creare il carrello che meglio risponde alle vostre esigenze. Le due gambe agli angoli opposti creano uno spazio tale da agevolare la facilità di carico.

Service trolley suitable for any use. A 3-tier base to which you can combine various components to create the trolley that best meets your requirements. The two legs at opposite corners create a space that allow easy loading.



Telaio resistente in acciaio inossidabile
 Resistant stainless steel structure

Ripiani in legno massiccio verniciato
 Varnished solid wood tiers

Facilità di carico
 Easy loading





Top dolci/formaggi refrigerato

Pastry/cheese top, refrigerated
 Etagère à pâtisseries ou fromages réfrigérée
 Bandeja postres o quesos refrigerada
 Kühlaufsatz für Kuchen und Käse

| | Cm | H. Cm | In. | H. In. |
|---------------|-------|-------|---------------|--------|
| 319 04 51 683 | 90x50 | 30 | 35,3/8x19,3/4 | 11,3/4 |



Vassoio estraibile in acciaio inossidabile con fori drenaggio condensa
 Stainless steel pull-out tray with holes for condensation



Top flambé a gas

Flambé top, gas
 Etagère flambé à gas
 Bandeja flambeado a gas
 Flambieraufsatz, Gas

| | Cm | H. Cm | In. | H. In. |
|---------------|-------|-------|---------------|--------|
| 319 04 51 684 | 90x50 | 9,5 | 35,3/8x19,3/4 | 3,3/4 |



Top bar con ringhiera

Bar top with railing
 Etagère bar avec rack en acier
 Bandeja bar con barandilla
 Aufsatz für Barservierwagen mit Rand

| | Cm | H. Cm | In. | H. In. |
|---------------|-------|-------|---------------|--------|
| 319 04 51 685 | 90x50 | 9,5 | 35,3/8x19,3/4 | 3,3/4 |
| 319 04 51 686 | 70x50 | 9,5 | 27,1/2x19,3/4 | 3,3/4 |



Top bar con ringhiera

Bar top with railing
 Etagère bar avec rack en acier
 Bandeja bar con barandilla
 Aufsatz für Barservierwagen mit Rand

| | Cm | H. Cm | In. | H. In. |
|---------------|-------|-------|---------------|--------|
| 319 04 51 687 | 50x50 | 9,5 | 19,3/4x19,3/4 | 3,3/4 |
| 319 04 51 688 | 40x50 | 9,5 | 15,3/4x19,3/4 | 3,34 |



(in appoggio sulla ringhiera del top bar)
(to be placed on the bar top railing)

Tagliere acciaio con portacondimenti

Steel tray with condiment holder.
Planche perforée acier avec bac condiments
Planchita perforada acero con porta condimentos
Edelstahlbrett mit Soßenhalter

| | Cm | H. Cm | In. | H. In. |
|---------------|-------|-------|--------------|--------|
| 319 04 51 690 | 20x50 | 8 | 7,7/8x19,3/4 | 3,1/8 |



Vasca ghiaccio

Ice pan
Bac à glaçons
Cubeta hielo
Eisschale

| | Cm | H. Cm | In. | H. In. |
|---------------|-------|-------|--------------|--------|
| 319 04 51 689 | 20x50 | 9,5 | 7,7/8x19,3/4 | 3,3/4 |



Portasorbettiere completo 2 posti

Sherbet pots with stand, double
Support sorbetières avec 2 sorbetières
Soporte para sorbeteras con 2 sorbeteras
Sorbetshalter komplett, 2-fach

| | Cm | H. Cm | In. | H. In. |
|---------------|-------|-------|--------------|--------|
| 319 04 51 694 | 20x50 | 19 | 7,7/8x19,3/4 | 7,1/2 |



Supporto per sorbettiere 2 posti

Pigreco stand for sherbet pots, double
Support pour 2 sorbetières
Soporte para 2 sorbeteras
Nur Halter für Sorbetshalter 2-fach schwarz

| | Cm | H. Cm | In. | H. In. |
|---------------|-------|-------|--------------|--------|
| 319 04 51 693 | 20x50 | 19 | 7,7/8x19,3/4 | 7,1/2 |



Portaglacette completo 3 posti

Bottle cooler holder, triple
Support rafraîchisseur à bouteilles 3 bouteilles
Soporte enfriador botellas 3 enfriadores
Weinkühlerhalter, 3-fach

| | Cm | H. Cm | In. | H. In. |
|---------------|-------|-------|--------------|--------|
| 319 04 51 692 | 20x50 | 21,5 | 7,7/8x19,3/4 | 8,1/2 |



Portabottiglie 3 posti

Bottle holder, triple
Porte-bouteilles 3 bouteilles
Porta botellas 3 botellas
Flaschenhalter, 3-fach

| | Cm | H. Cm | In. | H. In. |
|---------------|-------|-------|--------------|--------|
| 319 04 51 691 | 20x50 | 9,5 | 7,7/8x19,3/4 | 3,3/4 |



Top dolci/formaggi refrigerato

Pastry/cheese top, refrigerated

Etagère à pâtisseries ou fromages réfrigérée

Bandeja postres o quesos refrigerada

Kühlauflsatz für Kuchen und Käse



| | Cm | H. Cm | In. | H. In. |
|---------------|-------|-------|---------------|--------|
| 319 04 51 683 | 90x50 | 30 | 35,3/8x19,3/4 | 11,3/4 |



Top bar con ringhiera

Bar top with railing

Etagère bar avec rack en acier

Bandeja bar con barandilla

Aufsatz für Barservierwagen mit Rand



| | Cm | H. Cm | In. | H. In. |
|---------------|-------|-------|---------------|--------|
| 319 04 51 685 | 90x50 | 9,5 | 35,3/8x19,3/4 | 3,3/4 |



Top flambé a gas

Flambé top, gas

Etagère flambé à gas

Bandeja flambeado a gas

Flambieraufsatz, Gas



| | Cm | H. Cm | In. | H. In. |
|---------------|-------|-------|---------------|--------|
| 319 04 51 684 | 90x50 | 9,5 | 35,3/8x19,3/4 | 3,3/4 |



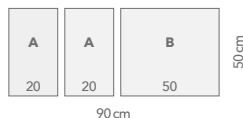

| | Cm | H. Cm | In. | H. In. |
|----------------------|-------|-------|---------------|--------|
| A: 2 x 319 04 51 694 | 20x50 | 19 | 7,7/8x19,3/4 | 7,1/2 |
| B: 1 x 319 04 51 687 | 50x50 | 9,5 | 19,3/4x19,3/4 | 3,3/4 |

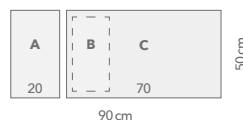

| | Cm | H. Cm | In. | H. In. |
|----------------------|-------|-------|---------------|--------|
| A: 1 x 319 04 51 689 | 20x50 | 9,5 | 7,7/8x19,3/4 | 3,3/4 |
| B: 1 x 319 04 51 690 | | | | |
| C: 1 x 319 04 51 686 | 70x50 | 9,5 | 27,1/2x19,3/4 | 3,3/4 |

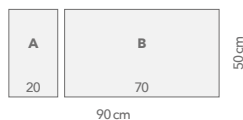

| | Cm | H. Cm | In. | H. In. |
|----------------------|-------|-------|---------------|--------|
| A: 1 x 319 04 51 694 | 20x50 | 19 | 7,7/8x19,3/4 | 7,1/2 |
| B: 1 x 319 04 51 686 | 70x50 | 9,5 | 27,1/2x19,3/4 | 3,3/4 |

Pigreco

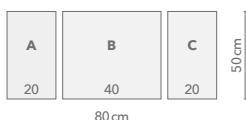

| | Cm | H. Cm | In. | H. In. |
|----------------------|-------|-------|---------------|--------|
| A: 1 x 319 04 51 691 | 20x50 | 9,5 | 7,7/8x19,3/4 | 3,3/4 |
| B: 1 x 319 04 51 688 | 40x50 | 9,5 | 15,3/4x19,3/4 | 3,3/4 |
| C: 1 x 319 04 51 692 | 20x50 | 21,5 | 7,7/8x19,3/4 | 8,1/2 |



80cm



| | Cm | H. Cm | In. | H. In. |
|-------------------|-------|-------|---------------|--------|
| 2 x 319 04 51 688 | 40x50 | 9,5 | 15,3/4x19,3/4 | 3,3/4 |

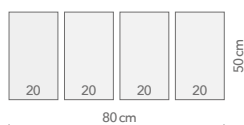

4 x 319 04 51 691

| Cm | H. Cm | In. | H. In. |
|-------|-------|--------------|--------|
| 20x50 | 9,5 | 7,7/8x19,3/4 | 3,3/4 |

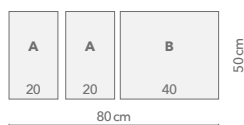

A: 2 x 319 04 51 692
B: 1 x 319 04 51 688

| Cm | H. Cm | In. | H. In. |
|-------|-------|---------------|--------|
| 20x50 | 21,5 | 7,7/8x19,3/4 | 8,1/2 |
| 40x50 | 9,5 | 15,3/4x19,3/4 | 3,3/4 |

Carrello arrosti

Roast beef trolley

Table roulante à boeuf

Carro para carne asada

Fleischwagen

| | Cm | H. Cm | In. | H. In. |
|---------------|--------|-------|----------------|--------|
| 319 04 51 728 | 80x108 | 112 | 31,1/2x 42,1/2 | 44,1/8 |



Carrello bolliti

Boiled meat trolley
Table roulante à plat du jour
Carro para cocidos
Menüwagen

| | | | | |
|---------------|--------|-------|---------------|--------|
| | Cm | H. Cm | In. | H. In. |
| 319 04 51 729 | 60x108 | 112 | 23,5/8x42,1/2 | 44,1/8 |



Carrello cocktail

Cocktail trolley
Chariot cocktail
Carro cocktail
Cocktails Servierwagen

| | Cm | H. Cm | In. | H. In. |
|---------------|---------|-------|---------------|--------|
| 319 04 51 699 | 50 x 90 | 91,5 | 35,3/8x19,3/4 | 36 |

Carrello per il servizio al tavolo ideale per la preparazione di cocktail di ogni tipo. Il carrello è dotato di top in legno con finiture e accessori in acciaio inox lucidato a specchio. Contiene portaglacette, portabottiglie, vasca ghiaccio e tagliere in acciaio con porta condimenti.

Service trolley, perfect to prepare every cocktail. The trolley is provided with wood top with mirror-polished, stainless steel finish and accessories. It comes with bottle cooler holder, bottle holder, ice pan and steel tray with condiment holder.



Tagliere in acciaio con portacondimenti
 Steel tray with condiment holder



Portaglacette completo 3 posti
 Bottle cooler holder, triple



Portabottiglie 3 posti
 Bottle holder, triple



Carrello dolci/formaggi 3 ripiani refrigerato

Trolley for pastry/cheese, 3-tier refrigerated
 Chariot pâtisseries/fromages 3 étagères réfrigéré
 Carro postres/queso 3 niveles refrigerado
 Servierwagen für Käse/Desserts mit Kühlung

| | Cm | H. Cm | In. | H. In. |
|---------------|---------|-------|---------------|--------|
| 319 04 51 695 | 50 x 90 | 112 | 35,3/8x19,3/4 | 45,1/8 |

Carrello a 3 ripiani per il servizio al tavolo di dolci o formaggi oppure per il servizio a buffet, refrigerato con eutettici. Il carrello è dotato di top in legno con finiture ed accessori in acciaio inox lucidato a specchio.

3-tier service trolley for dessert or cheese or buffet service, with ice-pack cooling. The trolley is provided with wood top with mirror-polished stainless steel finish and accessories.

Vassoio estraibile in acciaio inossidabile con fori drenaggio condensa
 Stainless steel pull-out tray with holes for condensation

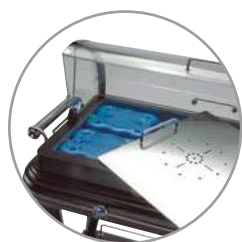

Top refrigerato con eutettici
 Ice-pack cooling top



Vassoio estraibile in acciaio inossidabile con fori drenaggio condensa
 Stainless steel pull-out tray with holes for condensation



Poggiapiatto estraibile in legno
 Wood removable tray



Carrello bar

Bar trolley
Chariot bar
Carro bar
Bar Servierwagen

| | Cm | H. Cm | In. | H. In. |
|---------------|---------|-------|---------------|--------|
| 319 04 51 697 | 50 x 90 | 91,5 | 35,3/8x19,3/4 | 36 |

Carrello per il servizio al tavolo di liquori e digestivi. Il carrello è dotato di top in legno con ringhiera in acciaio inox lucidata a specchio.

Service trolley for liquor and drinks. The trolley is provided with wood top with mirror-polished stainless steel railing.



Top bar con ringhiera
Bar top with railing



Pratica maniglia in acciaio inossidabile
Practical stainless steel handle



Ruota pivotante rivestita con gomma antistatica
Pivoting wheel with anti-static rubber



Carrello vini/liquori

Wine/liquor trolley
 Chariot vins/liqueurs
 Carro vinos/licores
 Servierwagen für Likör

| | Cm | H. Cm | In. | H. In. |
|---------------|---------|-------|---------------|--------|
| 319 04 51 698 | 50 x 90 | 91,5 | 35,3/8x19,3/4 | 36 |

Carrello per il servizio al tavolo di liquori e digestivi. Il carrello è dotato di top in legno con ringhiera in acciaio inox lucidata a specchio. Il carrello include anche porta bottiglie e porta glacette.

Service trolley for liquor and drinks. The trolley is provided with wood top with mirror polished stainless steel railing. It also comes with bottle holder and bottle cooler holder.



Top bar con ringhiera
 Bar top with railing



Portaglacette completo 3 posti
 Bottle cooler holder, triple



Portabottiglie 3 posti
 Bottle holder, triple



Carrello sorbetti

Sherbet trolley

Chariot sorbets

Carro sorbetes

Servierwagen mit Etagen für Speiseeis und Sorbett

| | Cm | H. Cm | In. | H. In. |
|---------------|---------|-------|---------------|--------|
| 319 04 51 700 | 50 x 90 | 101 | 35,3/8x19,3/4 | 39,3/4 |

Carrello per il servizio al tavolo di gelato e sorbetti. Il carrello è dotato di top in legno con finiture ed accessori in acciaio inox lucidato a specchio. La sorbettiera è isoterma, a doppio corpo.

Service trolley for ice creams and sherbets. The trolley is provided with wood top with mirror-polished stainless steel finish and accessories. The sherbet pot is isothermal, double-wall.



Top bar con ringhiera
Bar top with railing



Portasorbettiere completo 2 posti
Sherbet pots with stand, double



Facilità di carico
Easy loading



Carrello flambé

Flambé trolley
Chariot flambé
Carro flameado
Flambierwagen

| | Cm | H. Cm | In. | H. In. |
|---------------|---------|-------|---------------|--------|
| 319 04 51 696 | 50 x 90 | 91,5 | 35,3/8x19,3/4 | 36 |

Carrello per il servizio al tavolo.
Il piano di lavoro è in acciaio inox. Il piano di servizio inferiore ha un portabottiglie laterale con finiture in acciaio inossidabile. Il fornello sul piano superiore, con dispositivo di accensione e regolatore manuale di fiamma, è l'ideale per preparare un perfetto flambé.

Flambé service trolley. The working top is stainless steel. The lower service top has a side bottle opener with stainless steel finish. The burner on the upper top, with ignition device and flame adjuster, is the ideal to prepare a perfect flambé!



Fuoco con regolatore di fiamma
Flambé top



Piano in acciaio Inox
Stainless steel tier



Portabottiglie 3 posti
Bottle holder, triple



Disponibile anche nel colore olmo

Elm colour available as well

Disponibile aussi dans la couleur orme

Disponibile también en el color olmo

Verfügbar auch in Ulme

... 56 ...



Carrello Gueridon

Gueridon trolley
Chariot Gueridon
Carro Queridon
Gueridonwagen

| | Cm | H. Cm | In. | H. In. |
|---------------|---------|-------|-----------------|--------|
| 319 04 51 706 | 80 x 50 | 80 | 31,1/2 x 19,3/4 | 31,1/2 |



I carrelli della linea Classica di Broggi sono realizzati

in legno massello di faggio verniciato con tinta a base di acqua nel rispetto della normativa europea in materia di idoneità al contatto con gli alimenti. La struttura del carrello, monoblocco ed autoportante, è molto robusta. La lavorazione artigianale è effettuata con l'utilizzo di macchine CNC e le parti metalliche sono realizzate in acciaio inossidabile AISI 304. Tutta la gamma è fornita nella classica ed elegante colorazione mogano Broggi. Hanno 4 ruote pivotanti da 125 mm di diametro con freno di stazionamento meccanico e rivestimento in silicone morbido ed adatte a superare le asperità del pavimento. E' possibile produrre versioni in colori speciali su richiesta del cliente con un sovrapprezzo da stabilire. Altrettanto su richiesta del cliente è possibile realizzare versioni speciali dei carrelli con funzioni diverse. Ogni carrello è fornito di imballo singolo e palletizzato.

Classica trolleys by Broggi are made from solid

beechwood, varnished using water-based paints in accordance with European regulations on suitability for food contact. The freestanding, one-piece frame of the trolley is very sturdy. CNC machines are used for a careful manufacturing process and metal parts are made of AISI 304 stainless steel. The entire range comes in the classic and elegant Broggi mahogany colour. The trolley features four ø125-mm swivel casters plus mechanical brake and a soft silicone coating, suitable to adjust to uneven and rugged floors. Upon request trolleys in special colours can be made at a surcharge to be defined. Special trolley versions featuring different functions can also be made upon request. Each trolley is delivered in a single package and palletised.

Die Servierwagen der Linie Classica von Broggi sind

aus massivem Buchenholz, lackiert mit Farblack auf Wasserbasis nach den Vorgaben der europäischen Richtlinie für Gegenstände, die mit Lebensmitteln in Berührung kommen. Der Servierwagen zeichnet sich durch eine sehr robuste, selbsttragende Blockstruktur aus. Die handwerkliche Fertigung erfolgt unter dem Einsatz von CNC Maschinen, die Metallteile sind aus rostfreiem Stahl AISI 304. Die gesamte Serie steht im klassisch eleganten Farbton Mahagoni Broggi zur Verfügung. Der Wagen hat 4 Drehräder von 125 mm Durchmesser mit mechanischer Feststellbremse und weicher Silikonbeschichtung, die für alle Arten von Fußböden geeignet ist. Nach Kundenwunsch können Ausführungen in anderen Farben gegen Aufschlag nach Vereinbarung hergestellt werden. Außerdem sind spezielle Kundenanfertigungen von Servierwagen mit verschiedenen Funktionen möglich. Jeder Wagen wird einzeln verpackt auf Paletten geliefert.

Les chariots de la ligne Classica de Broggi sont réalisés

en bois de hêtre verni avec une peinture à base d'eau en conformité avec la réglementation européenne en matière d'aptitude au contact avec les aliments. La structure du chariot, monobloc et autoportante, est très solide. Le travail artisanal est effectué à l'aide de machines CNC et les pièces métalliques sont réalisées en acier inox AISI 304. Toute la gamme est fournie dans la classique et élégante couleur acajou Broggi. Ils ont 4 roues pivotantes de 125 mm de diamètre avec frein de stationnement mécanique et revêtement en silicone souple et appropriées pour surmonter les aspérités du plancher. Il est possible de produire des versions dans des couleurs spéciales à la demande du client avec un supplément à fixer. Toujours à la demande du client, il est possible de réaliser des versions spéciales des chariots avec des fonctions différentes. Chaque chariot est équipé d'emballage individuel et palettisé.

Los carros de la línea Classica de Broggi son

elaborados con madera maciza de haya barnizada con tinte a base de agua en el respeto de la normativa europea en materia de idoneidad para el contacto con los alimentos. La estructura del carro, monoblock y autoportante, es muy robusta. La elaboración artesanal se efectúa con el empleo de máquinas CNC y las partes metálicas son realizadas con acero inoxidable AISI 304. Toda la gama es suministrada en la clásica y elegante tonalidad caoba Broggi. Tienen 4 ruedas pivotantes de 125 mm de diámetro con freno de estacionamiento mecánico y revestimiento de silicona blanda adecuadas para superar las asperezas del piso. Es posible producir versiones de colores especiales a solicitud del cliente con un sobrepeso a establecer. Igualmente a solicitud del cliente es posible realizar versiones especiales de los carros con funciones diversas. Cada carro está dotado de embalaje singular y paletizado.



Carrelli
Classica



Carrello bolliti e arrosti

Roast beef and boiled meet trolley
Table roulante à boeuf et plat du jour
Carro para carne asada y cocidos
Fleisch-Menüwagen

Carrello per servire al tavolo i bolliti, con due portavivande grandi e uno più stretto, che possono essere regolabili in altezza e consentono di tagliare i bolliti senza toglierli dalla vasca.

Trolley to serve boiled meat, with two big food pans and a narrow one that can be adjusted in height, allowing to cut the meat without taking it out from the pan.

Carrello arrosti composto da tagliere in corian e due contenitori per salsa 14x14 Cm H. 12 Cm.

Roast beef trolley composed of corian carving board and two sauce container 14x14 Cm H. 12 Cm.



Poggiapiatto ribaltabile in acciaio inossidabile
Stainless steel plate stand, folding



Termostato regolabile e termometro digitale
Adjustable thermostat and digital thermometer



Supporto portacoltelli estraibile
Pull-out knife holder





Carrello arrosti

Roast beef trolley
 Table roulante à boeuf
 Carro para carne asada
 Fleischwagen

| | | |
|---------------|-----------------|--------|
| | Cm | H. Cm |
| 318 04 51 528 | 96 x 58 | 97 |
| | In. | H. In. |
| | 37,7/8 x 22,7/8 | 38,1/4 |



Carrello bolliti

Boiled meat trolley
 Table roulante à plat du jour
 Carro para cocidos
 Menüwagen

| | | |
|---------------|-----------------|--------|
| | Cm | H. Cm |
| 318 04 51 522 | 96 x 58 | 97 |
| | In. | H. In. |
| | 37,7/8 x 22,7/8 | 38,1/4 |

Carrello refrigerato ventilato

Ventilated refrigerated trolley
 Table roulante réfrigérée ventilée
 Carro refrigerado ventilado
 Wagen, mit Gelüfteter Kühlung

318 04 51 581 Refrigerato / Refrigerated

| Cm | H. Cm | In | H. In. |
|---------|-------|-------------------|--------|
| 92 x 52 | 105 | 43,1,1/4 x 23,5/8 | 43,114 |

Struttura in legno massello con piani impiallacciati. Vasca in acciaio inox AISI 304, dimensioni mm 700x395x90h. Foro sul fondo vasca per scarico condensa. Rubinetto per scarico acqua. Cupola in plexiglass semicilindrica con apertura su due lati. Pannello comandi con termostato digitale ed interruttore di accensione con spia luminosa. Tensione rete 230 Volt monofase 50/60hz. Cavo elettrico spiralato. Potenza 152 W. Temperatura di esercizio compresa tra 4°C e 10°C. Condensatore 3W. Ruote pivotanti mm 125 di cui due con freno. Dimensioni massime cm 92x52x105h.

*Solid wood structure with veneer decks
 AISI 304 stainless steel pan with
 dimensions mm 700x395x90h.
 Condense outlet hole on the bottom.
 Water outlet tap.
 Plexiglass semi-cylindrical dome cover
 with opening on two sides.
 Operation panel with digital thermostat
 and power switch with indicator light.
 230 Volt voltage, single phase 50/60hz
 Electric spiral cable.
 Power 152 W.
 Operating temperature between
 4°C and 10°C.
 3W evaporator.
 Pivoting wheels mm 125,
 with two brakes.
 Maximum dimensions
 cm 92x52x105h.*



Piano d'appoggio estraibile
 Pull-out top deck



Bordo metallico antiurto
 Shockproof metal edge



Cloche in plexiglass a due elementi semicirculari rientranti
 Plexiglass dome with two semicircular re-entering elements



Apribile su ambo i lati
 Opening in both directions

Carrello refrigerato statico

Static refrigerated trolley.

Table roulante réfrigérée statique

Carro refrigerado estático

Wagen, mit statische Kühlung

| | Cm | H. Cm | In. | H. In. |
|---------------|--------|-------|-----------------|--------|
| 318 04 51 540 | 110x60 | 105 | 36,1/4 x 20,1/2 | 41,3/8 |

Struttura in legno massello con piani impiallacciati. Vasca in acciaio inox AISI 304, dimensioni mm 740x422xH90h.

Foro sul fondo vasca per scarico condensa. Rubinetto per scarico acqua. Cupola in plexiglass semicilindrica con apertura su due lati. Pannello comandi con termostato digitale ed interruttore di accensione con spia luminosa. Tensione rete 230 Volt monofase 50/60hz.

Cavo elettrico spiralato

Potenza 152W.

Temperatura di esercizio compresa tra 4°C e 10°C.

Condensatore 10W.

Ruote pivotanti mm 125 di cui due con freno.

Dimensioni massime Cm 110x60x105h.

Solid wood structure with veneer decks. AISI 304 stainless steel pan with dimensions mm 740x422x90 h.

Condense outlet hole on the bottom. Water outlet tap.

Plexiglass semi-cylindrical dome cover with opening on two sides.

Operation panel with digital thermostat and power switch with indicator light. 230 Volt voltage, single phase 50/60hz.

Electric spiral cable.

Power 152W.

Operating temperature between 4°C and 10°C.

10W condenser.

Pivoting wheels mm 125, two with brakes.

Maximum dimensions Cm 110x60x105h.



Termostato a cristalli liquidi regolabile
Adjustable liquid crystal thermostat



Unità refrigerante
Compressor



Gancio laterale avvolgi cavo
Side cable hook



Carrello flambé a gas

Flambé trolley

Table roulante à flambée

Carro para flameado

Flambierwagen

| | Cm | H. Cm | In. | H. In. |
|---------------|---------|-------|-----------------|--------|
| 318 04 51 539 | 90 x 52 | 90 | 35,3/8 x 20,1/2 | 35,3/8 |

Carrello per il servizio del flambé al tavolo. Il piano di lavoro è in corian. Il piano di servizio inferiore ha una ringhiera di protezione ed è presente un portabottiglie laterale in acciaio inossidabile.

Il fornello ha la griglia asportabile ed il bruciatore ha un dispositivo di sicurezza termocoppia secondo la normativa CE, vano portabombola in legno, dispositivo di accensione piezoelettrico e regolatore di fiamma. E' disponibile in legno color ebano.

Flambé service trolley.

The working deck is corian.

The service lower deck has a protective barrier and a side stainless steel bottle holder.

The stove has a removable grate and the burner has a thermocouple security device complying with CE regulations, a wooden gas cylinder cabinet, a piezoelectric ignition device and a flame adjuster. It is available in ebony colour wood.



Cestello porta bottiglie / spezie in acciaio inossidabile
Stainless steel bottle / spice holder



Fuoco con griglia asportabile
Stove with removable grate



Dispositivo di accensione piezoelettrico e regolatore di fiamma
Piezoelectric ignition device and flame adjuster



Carrello Omicron

Omicron trolley
 Table roulante Omicron
 Carro Omicron
 Omicron Servierwagen

| | Cm | H. Cm | In. | H. In. |
|---------------|---------|-------|-----------------|--------|
| 318 04 51 680 | 92 x 52 | 120 | 36,1/4 x 20,1/2 | 47,1/4 |

Carrello per il servizio di dolci o formaggi. L'estrema maneggevolezza e le dimensioni contenute rendono il carrello adatto al servizio tra i tavoli. Cloche in plexiglass con apertura bilaterale. Il piano, refrigerato con piastre eutettiche, è ad avanzamento automatico con apertura cloche. Ruote pivotanti di cui due con freno.

*Cheese and dessert trolley
 Extreme manageability and small dimensions make it ideal for table service.
 Plexiglass cloche with two sides opening.
 The top, refrigerated with ice packs, slides automatically by opening the cloche.
 Pivoting wheels, two of which with brake with barrier.*



Maniglia in acciaio inox
 Stainless steel handle



Piano ad avanzamento automatico
 Automatic sliding top



Piano refrigerato con piastre eutettiche
 Top refrigerated with ice packs



Vassoio estraibile in acciaio inossidabile con fori drenaggio condensa
 Stainless steel pull-out tray with holes for condensation



Classica

Carrello Sigari

Cigar trolley

Chariot à cigares

Carro de servicio para puros

Servierwagen mit Zigarrenhalter

| | Cm | H. Cm | In. | H. In. |
|---------------|---------|-------|-----------------|--------|
| 318 04 51 678 | 92 x 52 | 98 | 36,1/4 x 20,1/2 | 32,1/4 |

Con alzata liquori

| | | | | |
|---------------|---------|-----|-----------------|--------|
| 318 04 51 679 | 92 x 52 | 125 | 36,1/4 x 20,1/2 | 49,1/4 |
|---------------|---------|-----|-----------------|--------|



Carrello per il servizio di sigari.

Cassetta sigari umidificata, realizzata in legno di cedro, vetrine in vetro con chiusura di sicurezza, umidificatore professionale, igrometro analogico per il controllo dell'umidità.

Il carrello, con l'aggiunta del top bar/liquori e alzata per calici, diventa l'ideale anche per il servizio di liquori.

Ruote pivotanti di cui due con freno.

Cigar trolley.

Cigar humidifier box, cedar wood, glass windows with safety lock, analog hygrometer for humidity control.

The trolley, with the bar/liqueur top and the goblet top, is the ideal for liqueur service. Pivoting wheels, two of which with brake.



Cassette sigari umidificate in legno di cedro
Cigar humidifier boxes, cedar wood

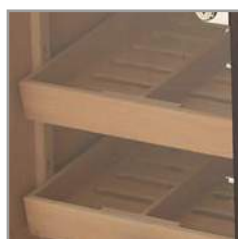

Igrometro analogico per il controllo dell'umidità
Analog hygrometer for humidity control



Vetrine con chiusure di sicurezza
Glass windows with safety lock



Carrello servire champagne tondo

Round champagne service trolley
 Table roulante de service à champagne
 Carro de servicio para champán
 Servierwagen für Champagne. rund

| | Ø Cm | H. Cm | Ø In. | H. In. |
|---------------|------|-------|--------|--------|
| 318 04 51 583 | 83 | 83 | 32,3/4 | 32,3/4 |

Coppa champagne Rubans non inclusa
 Punch bowl not included

Carrello tondo per il servizio di champagne di Ø 83 cm.
 Il carrello ha 16 fori per bicchieri del Ø di 9 cm e lo spazio per posizionare una coppa champagne.
 Ideale per il servizio al tavolo di champagne e non solo.
 Ruote pivotanti di cui due con freno.

*Round champagne trolley, Ø 83 cm.
 The trolley has 16 holes for glasses, Ø 9 cm, and room for a champagne bowl.
 Ideal for table service of champagne and more. Pivoting wheels, two of which with brake.*



Coppa champagne Rubans Ø Cm50
 Rubans champagne bowl, Ø Cm50



Piano di servizio inferiore con ringhiera di protezione
 Lower service deck with protective barrier



Sede alloggiamento bicchieri
 Champagne glass seat



Classica

Carrello servire

Service trolley
Table roulante de service
Carro de servicio
Servierwagen

| | Cm | H. Cm | In. | H. In. |
|---------------|---------|-------|-----------------|--------|
| 318 04 51 519 | 92 x 52 | 98 | 36,1/4 x 20,1/2 | 32,1/4 |

Carrello di servizio, funzionale per tutti gli utilizzi. E' in legno color ebano e puo'essere dotato di tops diversi,specifici per l'uso. Il carrello servire puo' diventare carrello per presentazione del pesce, carrello bar liquori, carrello dolci e formaggi refrigerato,carrello per insalata ed antipasti, carrello per gelati e sorbetti.

Service trolley, functional for all uses. It is in ebony colour wood, and can be provided with different specific tops. The service trolley can be a fish display trolley, a liquor trolley, a refrigerated trolley for pastry and cheese, a salad and hors d'oeuvre trolley, or an ice-cream and sherbet trolley.



Maniglie in acciaio inox
Stainless steel handles



Ruota pivotante rivestita con gomma antistatica
Pivoting wheel with anti-static rubber tyre



Piano di servizio inferiore con ringhiera di protezione
Lower service deck with protective barrier



Carrello servire 3 piani

Service trolley, 3-tier
 Chariot de service 3 étagères
 Carro servizio 3 niveles
 Servierwagen, 3-stufig

| | Cm | H. Cm | In. | H. In. |
|---------------|---------|-------|-----------------|--------|
| 318 04 51 646 | 92 x 52 | 98 | 36,1/4 x 20,1/2 | 32,1/4 |

Il nuovo carrello di servizio con tre ripiani, funzionale per tutti gli utilizzi.
 E' in legno color ebano e può essere dotato di tops diversi, specifici per l'uso.

*The new 3-shelves service trolley, functional for all uses.
 It is in ebony colour wood, and can be provided with different specific tops.*



Bordo metallico antiurto
 Shock proof metal edge



Piano d'appoggio estraibile
 Pull-out top deck



Piano di servizio inferiore con ringhiera di protezione
 Lower service deck with protective barrier



Classica



Top bar / liquori con alzata per calici per carrello servire

Service trolley liquor top with goblet stand

| | | | | |
|---------------|---------------|-------------|--------------------|------------------|
| 318 04 51 526 | Cm 84 x 45 | H. Cm 46 | In. 33 x 17,3/4 | H. In. 18,1/8 |
|---------------|---------------|-------------|--------------------|------------------|



Top bar / liquori per carrello servire

Service trolley liquor top

| | | |
|---------------|---------------|------------------|
| 318 04 51 520 | Cm 84 x 45 | In. 33x17,3/4 |
|---------------|---------------|------------------|



Top gelati e sorbetti per carrello servire

Service trolley ice-cream and sherbet top

| | | |
|---------------|---------------|--------------------|
| 318 04 51 542 | Cm 84 x 45 | In. 33 x 17,3/4 |
|---------------|---------------|--------------------|



Top servire liquori

Liquor service top

| | | |
|---------------|-------------|-----------------------|
| 318 04 51 705 | Cm 84x45 | In. 33 x 17,3/4 in |
|---------------|-------------|-----------------------|



Carrello servire

Service trolley with pull-out top deck

| | | | | |
|---------------|---------------|-------------|------------------------|------------------|
| 318 04 51 519 | Cm 92 x 52 | H. Cm 82 | In. 36,1/4 x 20,1/2 | H. In. 32,1/4 |
|---------------|---------------|-------------|------------------------|------------------|



Top refrigerato per presentazione pesce per carrello servire

Service trolley refrigerated top for fish display

| | | |
|---------------|---------|-------------|
| | Cm | In. |
| 318 04 51 543 | 84 x 45 | 33 x 17,3/4 |



Top dolci e formaggi refrigerato per carrello servire

Service trolley refrigerated top for pastry and cheese

| | | | | |
|---------------|---------|-------|-----------------|--------|
| | Cm | H. Cm | In. | H. In. |
| 318 04 51 521 | 79 x 44 | 29 | 31,1/8 x 17,3/8 | 11,1/2 |



Top pasticceria 2 piani refrigerato per carrello servire

Dessert refrigerated top for service trolley, 2-tier

| | | | | |
|---------------|---------|-------|-------------|--------|
| | Cm | H. Cm | In. | H. In. |
| 318 04 51 675 | 76 x 42 | 52 | 30 x 16,1/2 | 20,1/2 |



Carrello servire 3 piani

Service trolley with pull-out top deck

| | | | | |
|---------------|---------|-------|-----------------|--------|
| | Cm | H. Cm | In. | H. In. |
| 318 04 51 646 | 92 x 52 | 82 | 36,1/4 x 20,1/2 | 32,1/4 |

Carrello servire pasticceria/formaggi

Service trolley with refrigerated top for cheese

Table roulante de service avec étagère à fromages réfrigérée

Carro de servicio con bandeja para quesos refrigerante

Servierwagen mit Etage für Käse mit Kühlung

318 04 51 547 Refrigerato / Refrigerated

| Cm | H. Cm | In. | H. In. |
|---------|-------|-----------------|--------|
| 92 x 52 | 112 | 36,1/4 x 20,1/2 | 44 |

Carrello per il servizio al tavolo di dolci o formaggi oppure per il servizio a buffet, refrigerato con eutettici. Il carrello è dotato di top in legno color ebano con finiture e accessori in acciaio inox lucidato a specchio.

Service trolley for cheese and pastry or buffet service, with ice-pack cooling. The trolley is provided with an ebony colour top, with mirror-polished stainless steel finishing and accessories.



Piano d'appoggio estraibile
Pull-out top deck



Set dolci e formaggi
Pastry and cheese set



Vassoio estraibile in acciaio inossidabile con fori drenaggio condensa
Stainless steel pull-out tray with holes for condensation



Carrello servire con top gelati e sorbetti

Service trolley with ice-cream and sherbet top
 Table roulante de service avec étagère à glaces et sorbets
 Carro de servicio con bandeja para helados y sorbetes
 Servierwagen mit Etage für Speiseeis und Sorbett

| | Cm | H. Cm | In. | H. In. |
|---------------|---------|-------|-----------------|--------|
| 318 04 51 549 | 92 x 52 | 120 | 36,1/4 x 20,1/2 | 47,1/4 |

Carrello per il servizio al tavolo di gelato e sorbetti. Il carrello è dotato di top in legno color ebano con finiture e accessori in acciaio inossidabile lucidato a specchio. La sorbettiera è isotermaica, a doppio corpo.

Service trolley for ice-creams and sherbets. The trolley is provided with ebony colour wooden top, mirror-polished stainless steel finishing and accessories. The sherbet pot is isothermal, double-wall.



Sorbettiera isotermaica
 Isothermal sherbet pot



Piano con 4 sorbettiere
 Deck with 4 sherbet pots



Piano d'appoggio estraibile
 Pull-out top deck



Carrello servire con top refrigerato per presentazione pesce

Service trolley with refrigerated top for fish display

Table roulante de service avec étagère réfrigérée à poisson

Carro de servicio con bandeja refrigerante para pescado

Servierwagen mit Etage für Fisch mit Kühlung

| | Cm | H. Cm | In. | H. In. |
|---------------|---------|-------|-----------------|--------|
| 318 04 51 544 | 92 x 52 | 85 | 36,1/4 x 20,1/2 | 33,1/2 |

Carrello per la presentazione del pesce fresco, refrigerato direttamente con ghiaccio. Il carrello è dotato di top in legno color ebano e di piano inferiore con ringhiera.

Trolley for fresh fish display with ice cooling. The trolley is provided with ebony colour wooden top and lower deck with barrier.



Vasca estraibile in acciaio
Pull-out stainless steel pan



Piano d'appoggio estraibile
Pull-out top deck



Refrigerazione con ghiaccio
Ice cooling



Carrello servire con top bar / liquori e alzata per calici

Service trolley with liquor top and goblet stand

Table roulante de service avec étagère à liqueurs et tablette pour verres à pied

Carro de servicio con bandeja para licores y bandejita para copas

Servierwagen mit Etage für Likör und Gläser

| | Cm | H. Cm | In. | H. In. |
|---------------|---------|-------|-----------------|--------|
| 318 04 51 546 | 92 x 52 | 127 | 36,1/4 x 20,1/2 | 50 |

Carrello per il servizio al tavolo di liquori e digestivi. Il carrello è dotato di top in legno color ebano con finiture e accessori in acciaio inox lucidato a specchio. Pratico anche nella versione con l'alzata per calici con ringhiera di protezione.

Service trolley for liquor and digestives. The trolley is provided with ebony colour wooden top, mirror-polished stainless steel finishing and accessories. It is practical also in its version with the goblet stand with protective barrier. It is practical also in its version with the goblet stand with protective barrier.



Alzata per calici con ringhiera di protezione
Goblet stand with protective barrier



Ancoraggio a rotaia per calici
Rail fixing for goblets



Ruota pivotante rivestita con gommaantistatica
Pivoting wheel with anti-static rubber tyre



Carrello servire con top bar

Liquori Service trolley with liquor top
 Table roulante de service avec étagère à liqueurs
 Carro de servicio con bandeja para licores
 Servierwagen mit Etage für Likör

| | Cm | H. Cm | In. | H. In. |
|---------------|---------|-------|-----------------|--------|
| 318 04 51 545 | 92 x 52 | 100 | 36,1/4 x 20,1/2 | 39,1/2 |

Carrello per il servizio al tavolo di liquori e digestivi. Il carrello è dotato di top in legno color ebano con finiture e accessori in acciaio inox lucidato a specchio.

Service trolley for liquor and digestives. The trolley is provided with ebony colour wooden top, mirror-polished stainless steel finishing and accessories.



Piano di servizio inferiore
 Lower service deck



Piano d'appoggio estraibile
 Pull-out top deck



Ringhiera di protezione superiore e maniglie in acciaio inox
 Top deck protective barrier with stainless steel handles



Carrello Gueridon lusso

Gueridon trolley, de luxe
 Table roulante guéridon de luxe
 Carro queridon lujo
 Gueridonwagen De Luxe

| | Cm | H. Cm | In. | H. In. |
|---------------|---------|-------|-------------|--------|
| 318 04 51 524 | 78 x 48 | 80 | 30,3/4 x 19 | 31,1/2 |

Carrello per il servizio al tavolo di dolci, pesce o formaggi, oppure per il servizio a buffet.

Service trolley for pastry, fish, cheese or buffet.



Gamba sagomata de luxe
 De luxe shaped leg



Piano inferiore con bordo
 Lower deck with edge



Ruota pivotante rivestita con gomma antistatica
 Pivoting wheel with anti-static rubber tyre



Classica

Gamma colori

I carrelli Broggi possono essere prodotti, oltre che nel tradizionale color ebano, anche in alcuni colori speciali, come raffigurato nella tabella sottostante.

IMPORTANTE

Essendo il legno un prodotto naturale, i colori qui riprodotti sono indicativi. I nostri prodotti potrebbero essere soggetti a piccole variazioni di colore, lucentezza o intensità di venature che rientrano nella tolleranza. Eventuali differenze cromatiche rispetto ai campioni o a precedenti spedizioni non costituiscono quindi motivo di reclamo.

Colour range

In addition to the traditional ebony colour, Broggi trolleys can be also manufactured in some special colours, as shown in the table.

IMPORTANT

Being wood a natural product, the colours shown here are indicative only. Our products could have slight colour, brightness or intensity grain variations, within tolerance limits. Possible colour differences in comparison with samples or previous shipments are not reasons for claim.

Gamme de couleurs

Les tables roulantes Broggi peuvent être produits, en plus que dans la couleur ébène traditionnelle, aussi dans quelques couleurs spéciales, représentées dans le tableau.

IMPORTANT

Puisque le bois est un produit naturel, les couleurs reproduites ici sont indicatives. Nos produits pourraient être sujets à des petites variations dans la couleur, dans le brillant où dans l'intensité des veinures qui rentrent dans la tolérance. D'éventuelles différences chromatiques en ce qui concerne les échantillons où les livraisons précédentes ne constituent donc pas une raison de réclamation valable.

Gama de colores

Los carros Broggi pueden ser producidos, además de en el tradicional color ébano, en algunos colores especiales también, como ilustrado en la tabla.

IMPORTANTE

Siendo la madera un producto natural, los colores aquí reproducidos son indicativos. Nuestros productos podrían tener pequeñas variaciones de color, brillo o intensidad de veta en los límites de tolerancia. Eventuales diferencias cromáticas con las muestras o las expediciones anteriores no constituyen motivos de reclamación

Farben

Unsere Mehrzweckwagen werden nicht nur in Ebenholz sondern auch in Sonderfarben produziert (Tabelle).

WICHTIG

Die abgebildeten Farben sind unverbindlich; Holz ist ein Naturprodukt. Unregelmässigkeiten in Farbe und Masserung sind ein Zeichen dafür. Gebeizte Oberflächen können in Farbe und Glanzgrad von Farbmustern oder früheren Lieferungen abweichen. Dies ist kein Reklamationsgrund.

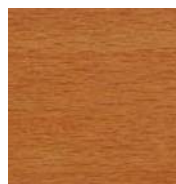

Cod. 51 **Mogano chiaro**

Light mahogany
Acajou clair
Caoba claro
Mahogani hell

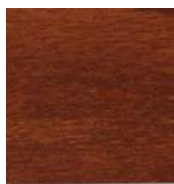

Cod. 52 **Mogano**

Mahogany
Acajou
Caoba
Mahogani

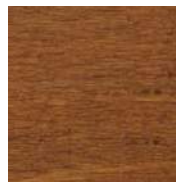

Cod. 54 **Noce scuro**

Dark walnut
Noyer foncé
Nogal oscuro
Nuss dunkel

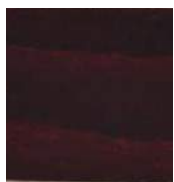

Cod. 55 **Palissandro**

Rosewood
Palissandre
Palisandro
Palisander

Manutenzione Wood

WoodMaintenance

MANUTENZIONE ARTICOLI IN LEGNO

Il legno è un materiale naturale e vivo, per questo è un'ottima materia prima per arredi, complementi e oggettistica.

Garantisce solidità, sicurezza e durata negli anni ma richiede anche interventi di manutenzione per conservare tutte le sue caratteristiche.

Esistono prodotti specifici per pulire e proteggere il legno nel rispetto della naturalezza di questo nobile materiale.

Come togliere i graffi dal legno:

In commercio esistono molti prodotti adatti per rimuovere i graffi dal legno come lucidanti pigmentati per mobili, applicabili con un panno pulito.

Per graffi particolarmente lievi o bordi sciupati è possibile usare dei markers per il ritocco che riescono a coprire graffi e segni di usura.

Per graffi più profondi è possibile usare una stecca di cera (del colore compatibile a quella del legno da riparare).

WOOD PRODUCTS MAINTENANCE

Wood is a natural and live material, consequently, it is an excellent raw material for furniture, accessories and objects.

It guarantees solidity, safety and durability over the years, however, it also requires maintenance in order to preserve all its characteristics.

There are specific products to clean and protect wood, respecting the naturalness of this noble material.

How to remove scratches from wood:

In the market there are many products suitable for removing scratches from wood like pigmented polishes, which can be applied with a clean cloth.

For light scratches or worn edges you can use touch-up markers, which can cover scratches and signs of wear.

For deep scratches you can use a wax stick (of colour compatible with the wood that needs repair).

Manutenzione PVD

PVDMaintenance

ISTRUZIONI D'USO E DI MANUTENZIONE PER LA POSATERIA ED IL VASELLAME IN PVD

Lavare accuratamente i prodotti prima di utilizzarli per la prima volta.

Dopo ogni utilizzo evitare di lasciare per tempi prolungati gli articoli sporchi a contatto con i residui alimentari e/o immersi nel liquido di rigoverno. Alcune sostanze contenute negli alimenti sono infatti dannose per il PVD e ne alterano l'aspetto. E' quindi importante lavare gli articoli utilizzati subito dopo l'uso.

In caso di lavaggio manuale utilizzare acqua calda e sapone neutro, risciacquare con abbondante acqua tiepida ed asciugare scrupolosamente tutti gli articoli dopo il lavaggio per evitare la formazione di macchie dovute a depositi calcarei contenuti nell'acqua. Evitare tassativamente l'utilizzo di pomice, paglietta d'acciaio, spugnette o panni impregnati di polveri abrasive.

In caso di lavaggio in lavastoviglie utilizzare un programma a temperatura non superiore a 60°C. Tenere separati i coltelli dalle altre posate (forchette e cucchiaini) e da altri articoli in acciaio inox. Escludere detersivi sintetici a base di cloro e con fosfati superiori al 10%, ossigeno o prodotti comunque candeggianti. È consigliabile estrarre ed asciugare accuratamente con un panno morbido tutti i pezzi subito dopo il lavaggio, anche se comprende un ciclo di asciugatura automatica. Non lasciare le posate e gli articoli in PVD nell'ambiente umido della lavastoviglie ma asciugarli e riporli in un ambiente asciutto.

Evitare di sottoporre i pezzi trattati in PVD a operazioni di pulizia o asciugatura utilizzando asciugatori o lucidatori automatici con azione di granuli, ceramici o paste/liquidi abrasivi. Possono essere invece utilizzati il tutolo di mais o detersivi non clorurati contenenti farina fossile. Non utilizzare lavastoviglie a osmosi.

In caso di leggero viraggio del colore o macchie calcaree persistenti pulire con panno morbido e aceto e successivamente risciacquare con abbondante acqua tiepida e asciugare accuratamente.

PVD CUTLERY AND PLATE INSTRUCCION OF USE AND MAINTENANCE

Wash up carefully the PVD items before their first use.

Do not leave for a long time the dirty items in contact with alimentary residues and/or immersed all together in the washing water. Some substances contained in the aliments are in fact harmful for PVD and could alter its surface aspect. So it's very important to wash up all articles immediately after their use.

In case of hand wash use hot water and a good neutral detergent to wash them up; later on rinse out with abundant tepid water and meticulously dry all articles after the washing to avoid eventually forming of stains of limestone contained in the water. Pumice, steel wool, sponge or cloth saturated with abrasive powder have to be strictly excluded.

In case of wash with dishwasher use a washing program at temperature not higher than 60°C. Take knives separated from other cutlery (forks and spoons) and other stainless steel kitchenware. Do not use to wash any synthetic detergents at chlorine and with phosphates in % more than 10%, oxygen base or similar detergents bleaching. Remove and dry meticulously all cutlery after the washing with a soft cloth, even if the dishwasher has a cycle of automatic drying (this is to remove to surface of cutlery any limestone stains). Do not leave cutlery in the humidity of dishwasher but dry and put them in a dry room.

You could use cutlery dryer polisher machines with corncob powder. Do not use ceramics or similar and scrupulously avoid any abrasive liquid.

Do not use osmosis dishwasher machine.

In case of slight shading of color, or persistent limestone spots, clean with soft cloth and vinegar.

Manutenzione Alpacca e Acciaio Argentato

EPNS and EPSS Maintenance

ISTRUZIONI D'USO E DI MANUTENZIONE PER LA POSATERIA ED IL VASELLAME IN ACCIAIO ARGENTATO E ALPACCA ARGENTATA

Lavare accuratamente i prodotti nuovi Utilizzare per il lavaggio acqua calda ed un buon sapone neutro, risciacquare in seguito con abbondante acqua tiepida ed asciugare scrupolosamente tutti gli articoli. Non utilizzare per il lavaggio detersivi sintetici a base di cloro o prodotti comunque candeggianti. Pomice, paglietta d'acciaio, spugnette o panni impregnati di polveri abrasive devono essere altresì rigorosamente esclusi. Possono invece essere utilizzati detersivi non clorurati contenente farina fossile. E' consigliato il lavaggio degli articoli argentati subito dopo il loro utilizzo. Qualora questo non fosse possibile è comunque importante non lasciare per caso di utilizzo degli articoli a pranzo articoli a cena, andrebbero lavati entro la mattina del giorno seguente). Nel caso fosse necessario un prelavaggio, questo deve essere fatto relativamente breve. Gli articoli non vanno infatti lasciati in ammollo quanto alcune sostanze contenute negli alimenti sono dannose per l'argentatura galvanica e ne alterano l'aspetto. Le lame dei coltelli prodotte con un pregiato acciaio inossidabile, sono sensibili agli attacchi corrosivi sviluppati dall'acido acetico, citrico, lattico ed in particolare da cloruro di sodio, presenti negli alimenti.

E' importante, sia in fase di prelavaggio che durante il lavaggio, tenere separate le normali posate (cucchiai, forchette, cucchiaini...) dai coltelli e da altri oggetti metallici presenti in cucina.

Nel caso di lavaggio in lavastoviglie le posate devono essere inserite in cestelli verticali di plastica e tenute separate dai coltelli.

Asciugare accuratamente gli articoli con un panno morbido subito dopo il lavaggio, anche se il lavaggio è eseguito in lavastoviglie che prevede un ciclo di asciugatura automatica. Questo è necessario per evitare l'eventuale formazione di macchie dovute a depositi calcarei contenuti nell'acqua.

Non lasciare le posate nell'ambiente umido della lavastoviglie una volta terminato il ciclo di lavaggio, ma asciugarle e riporle in un ambiente asciutto.

Per lo stoccaggio degli articoli argentati si consiglia l'utilizzo di cassette in plastica con coperchio che evitano il passaggio di aria e luce che faciliterebbero l'ossidazione dell'argento. E' molto importante riporre gli articoli nella cassa perfettamente asciutti. Per evitare rigature si consiglia di non inserire alla rinfusa gli articoli ma di riporli ordinatamente e proteggere i vari strati con un panno morbido. Questo sistema di stoccaggio evita il rilavaggio degli articoli prima del loro utilizzo.

L'argento per sua natura è portato a solforarsi in presenza dell'aria e della luce, assumendo prima o poi una colorazione scura più o meno uniforme. Ciò avviene anche per il contatto con alcune sostanze presenti negli alimenti (limone, aceto, maionese o salse, tuorlo d'uovo...) ed in tal caso si può notare la formazione di macchie. Si tratta comunque di un fenomeno naturale che non danneggia il rivestimento d'argento degli articoli ma che ne altera l'aspetto. Per ridare all'argenteria il suo originale splendore sono disponibili in commercio alcuni prodotti antiossidanti specifici per la pulizia dell'argento e appositamente preparati da case qualificate. Si sconsiglia l'uso frequente della Burnishing Machine. Utilizzare al massimo 2/3 volte l'anno e con sfere di acciaio inox AISI 304 (per evitare magnetizzazioni dell'argento), di piccolo diametro (ø max 3 mm). Successivamente gli articoli devono essere lucidati utilizzando tutolo di mais.

Un utilizzo più frequente della Burnishing Machine e l'utilizzo di sfere non idonee provoca inevitabilmente danni al prodotto con conseguente asportazione dell'argento dagli articoli e la corrosione dello stesso nella parte argentata magnetizzata.

INSTRUCTION OF USE AND MAINTENANCE OF SILVER PLATED STAINLESS STEEL AND ELECTRO-PLATED NICKEL SILVER CUTLERY AND HOLLOWWARE

Wash the new products carefully before use. Use hot water to wash them and a good neutral detergent; then, rinse out with tepid water and dry all the items thoroughly. When washing, do not use chlorinated detergents nor products containing bleach. Pumice, steel wool, sponges or cloths saturated with abrasive powders must be strictly avoided. However, detergents without chloride containing fossil flour can be used. The washing of plated items after use is recommended. In case that would not be possible, it is however important not to leave for more than 12 hours the dirty items in contact with food leftovers (e.g.: if the items are used at lunch, they should be washed within the evening; if the items are used at dinner, they should be washed within the following morning). In case a prewash was needed, it must be carried out just before the washing and for a relatively short time. In fact, the items must not be soaked in the washing solution for too long, since some substances contained in food are damaging for the electroplating and change its appearance. Knives blades are manufactured with a valuable stainless steel and are sensitive to the corrosion attacks developed by acetic, citric and lactic acid and in particular to sodium chloride present in food.

In case of washing in dishwasher, spoons and forks must be placed into plastic vertical baskets and kept separated from knives.

Dry the items thoroughly immediately after the washing with a soft cloth, even if your dishwasher has a dry cycle. That is necessary in order to avoid the possible formation of stains caused by calcareous deposits contained in the water.

Do not leave the cutlery in the humid environment of the dishwasher once the washing finishes; dry them and store them in a dry place.

For the storage of the silver plated items it is recommended the use of plastic boxes with cover, in order to avoid air and light that could facilitate the oxidation of silver. It is very important that the items are replaced in the box perfectly dry. In order to avoid scratches, it is recommended not to place the items in the box randomly, but to place them in an orderly way and protect the various layers with a soft cloth. This storage method avoids the rewashing of the items before they are used.

Silver by its nature tends to tarnish with air and light, getting unevenly darker sooner or later. This is due to the contact with some substances contained in food (lemon, vinegar, mayonnaise or sauces, egg yolk...) and in this case you can notice the formation of stains. However, this is a natural event that does not damage the silver coating of the items but simply changes their appearance. In order to restore its original splendor to silverware, there are available in the market some antioxidant products for silver cleaning and specially prepared by qualified companies. The frequent use of the Burnishing Machine is not recommended. You can use it twice or three times a year maximum, with AISI 304 stainless steel spheres (to avoid silver magnetization), small diameter (ø max 3 mm). After that, the items must be polished using corn powder.

A more frequent use of the Burnishing Machine and the use of non suitable spheres inevitably causes damages to the products with the consequent removal of the silver coating from the items and the corrosion of the same in the magnetized silvered part.

ISTRUZIONI D'USO E DI MANUTENZIONE PER LA POSATERIA ED IL VASELLAME IN ACCIAIO

Lavare accuratamente i prodotti nuovi Utilizzare per il lavaggio acqua calda ed un buon sapone neutro, risciacquare in seguito con abbondante acqua tiepida ed asciugare scrupolosamente tutti gli articoli. Non utilizzare per il lavaggio detersivi sintetici a base di cloro o prodotti comunque candeggianti. Pomice, paglietta d'acciaio, spugnette o panni impregnati di polveri abrasive devono essere altresì rigorosamente esclusi. Possono invece essere utilizzati detersivi non clorurati contenente farina fossile. E' consigliato il lavaggio degli articoli subito dopo il loro utilizzo. Qualora questo non fosse possibile è comunque importante non lasciare per caso di utilizzo degli articoli a pranzo articoli a cena, andrebbero lavati entro la mattina del giorno seguente). Nel caso fosse necessario un prelavaggio, questo deve essere fatto relativamente breve. Gli articoli non vanno infatti lasciati in ammollo quanto alcune sostanze contenute negli alimenti sono dannose e ne alterano l'aspetto. Le lame dei coltelli prodotte con un pregiato acciaio inossidabile, sono sensibili agli attacchi corrosivi sviluppati dall'acido acetico, citrico, lattico ed in particolare da cloruro di sodio, presenti negli alimenti.

E' importante, sia in fase di prelavaggio che durante il lavaggio, tenere separate le normali posate (cucchiai, forchette, cucchiaini...) dai coltelli e da altri oggetti metallici presenti in cucina.

Nel caso di lavaggio in lavastoviglie le posate devono essere inserite in cestelli verticali di plastica e tenute separate dai coltelli.

Asciugare accuratamente gli articoli con un panno morbido subito dopo il lavaggio, anche se il lavaggio è eseguito in lavastoviglie che prevede un ciclo di asciugatura automatica. Questo è necessario per evitare l'eventuale formazione di macchie dovute a depositi calcarei contenuti nell'acqua.

Non lasciare le posate nell'ambiente umido della lavastoviglie una volta terminato il ciclo di lavaggio, ma asciugarle e riporle in un ambiente asciutto.

INSTRUCTION OF USE AND MAINTENANCE OF STAINLESS STEEL CUTLERY AND HOLLOWWARE

Wash the new products carefully before use. Use hot water to wash them and a good neutral detergent; then, rinse out with tepid water and dry all the items thoroughly. When washing, do not use chlorinated detergents nor products containing bleach. Pumice, steel wool, sponges or cloths saturated with abrasive powders must be strictly avoided. However, detergents without chloride containing fossil flour can be used. The washing of items after use is recommended. In case that would not be possible, it is however important not to leave for more than 12 hours the dirty items in contact with food leftovers (e.g.: if the items are used at lunch, they should be washed within the evening; if the items are used at dinner, they should be washed within the following morning). In case a prewash was needed, it must be carried out just before the washing and for a relatively short time. In fact, the items must not be soaked in the washing solution for too long, since some substances contained in food are damaging for the electroplating and change its appearance. Knives blades are manufactured with a valuable stainless steel and are sensitive to the corrosion attacks developed by acetic, citric and lactic acid and in particular to sodium chloride present in food.

In case of washing in dishwasher, spoons and forks must be placed into plastic vertical baskets and kept separated from knives.

Dry the items thoroughly immediately after the washing with a soft cloth, even if your dishwasher has a dry cycle. That is necessary in order to avoid the possible formation of stains caused by calcareous deposits contained in the water.

Do not leave the cutlery in the humid environment of the dishwasher once the washing finishes; dry them and store them in a dry place.





1818

ABERT S.p.A.
Divisione Broggi 1818

Via Don P. Mazzolari, 17 25050 Passirano (BS) Italy

T. +39 030 6853601-602
F. +39 030 6853610
info@broggi.it

